

Commodore Business Machines, Inc.

901 California Avenue

Palo Alto, California 94304, USA

Commodore/MOS

Valley Forge Corporate Center

950 Rittenhouse Road

Norristown, Pennsylvania 19401, USA

Commodore Business Machines Limited

8370 Pharmacy Avenue

Agincourt, Ontario, Canada M1V 2K4

Commodore Business Machines Limited

Eaglescliffe Industrial Estate

Eaglescliffe, Stockton-on-Tees

Teeside, TS16 0PN, England

Commodore Büromaschinen GmbH

Frankfurter Strasse 174-175

6078 Neu Isenburg

West Germany

Commodore Japan Limited

Taisei-Denshi Building

8-14 Ikue 1-Chome

Asahi-Ku, Osaka 535, Japan

Commodore Electronics (Hong Kong) Ltd

Watsons Estates

Block C, 11th floor

Hong Kong, Hong Kong

The Decision Maker

by

commodore



model SR4912

User's Guide

Entire contents copyrighted 1978

Commodore International Limited

 **commodore**

Keyboard Index

	Pg		Pg		Pg
\pm/\mp	5	%	8	e^x	18
EE	5	D/R/G	9	log	18
C/CE	5	sin	11	10^x	19
INV	5	cos	11	STO	20
π	6	tan	11	RCL	20
+	6	D→R	14	M+	20
-	6	P→R	15	Mx	21
x	6	x^2	16	XCH	21
\div	6	\sqrt{x}	16	x_n	24
=	6	1/x	16	\bar{x}	24
$x \leftrightarrow y$	7	y^x	17	s	24
((8	$\sqrt[x]{y}$	17	s'	24
))	8	ln	18		

Introduction

The Commodore SR4912 Scientific calculator offers a wide variety of mathematical and statistical operations at a remarkably efficient cost.

The single 3/4" x 1/2" x 1/16" microprocessor chip is the heart and brains of your new calculator. It is unique; virtually no other calculator packs as much power in a single chip. This accounts for the remarkable cost efficiency. The chip is a product of the superb engineering and production skills of MOS Technology, a Commodore company.

This chip contains enough circuitry to generate trigonometric, inverse trigonometric, logarithmic, power and root functions. It can also compute conversions between degree and radian measures and between rectangular and polar coordinates. There are two levels of parentheses, three memories, and a percent operation which computes percentage and percent change.

A particularly useful feature is the statistical program. Enter a list of numbers and the machine will compute the sample mean \bar{x} , the standard deviation s , the sum Σx and the sum of squares Σx^2 .

This manual contains interesting examples of statistics and applied mathematics selected to familiarize the reader step by step with this machine. There is a comprehensive appendix containing a large number of useful statistics, mathematics and geometry formulae, as well as physical conversions, constants, units and two important statistical distributions.

We at Commodore take great pride in this calculator. We feel that exciting new applications in science, applied mathematics and statistics will be opened up to you, the lucky owner.

Table of Contents		Page
I. PRELIMINARIES		4
Power On		4
The Display		4
Display Shut-Off Feature		4
Entry		5
Scientific Form		5
The Clear Key C/CE		5
The Inverse Key INV		5
The Pi Key π		6
II. ARITHMETIC FUNCTIONS		6
Simple Arithmetic		6
Chaining		6
The $x \leftrightarrow y$ Key		7
Parentheses (())		8
The Percent Key %		8
III. TRIGONOMETRIC OPERATORS		9
The Angle Mode Key D/R/G		9
Trig Functions		10
The Trig Keys		11
Inverse Trig Functions		13
Degrees/Radians Conversion		14
Polar/Rectangular Coordinates		15
IV. ALGEBRAIC OPERATORS		16
x^2 \sqrt{x} $1/x$		16,17
y^x $\sqrt[y]{y}$		18
Properties of Exponents		18
V. TRANSCENDENTAL OPERATORS		18
ln e^x		18,19
log 10^x		19
Properties of Transcendental Functions		19

VI. MEMORIES	20
STO RCL	
M+ Mx	
XCH	20, 21

VII. STATISTICAL OPERATORS	23
The Statistical Keys	24
Confidence Intervals	24
Hypothesis Testing	26

APPENDICES	
A Statistical Tests	30
B Normal Distribution	32
C Students t-Distribution	34
D Derivatives	36
E Integrals	38
F Mathematical Formulae	40
G Geometry Formulae	41
H Conversions	42
I Physical Constants	44
J Table of Units	46
K Batteries and Maintenance	48

I. Preliminaries

Power On

Your Scientific calculator can run on battery power alone or you can connect to an optional AC adapter and use the calculator while the AC adapter is connected to an electric outlet. The calculator does not need a battery to run off the adapter.

Push the ON/OFF slide switch to the left to turn the calculator on. A red dot appears to the right of the switch and the display should read 0.

The Display

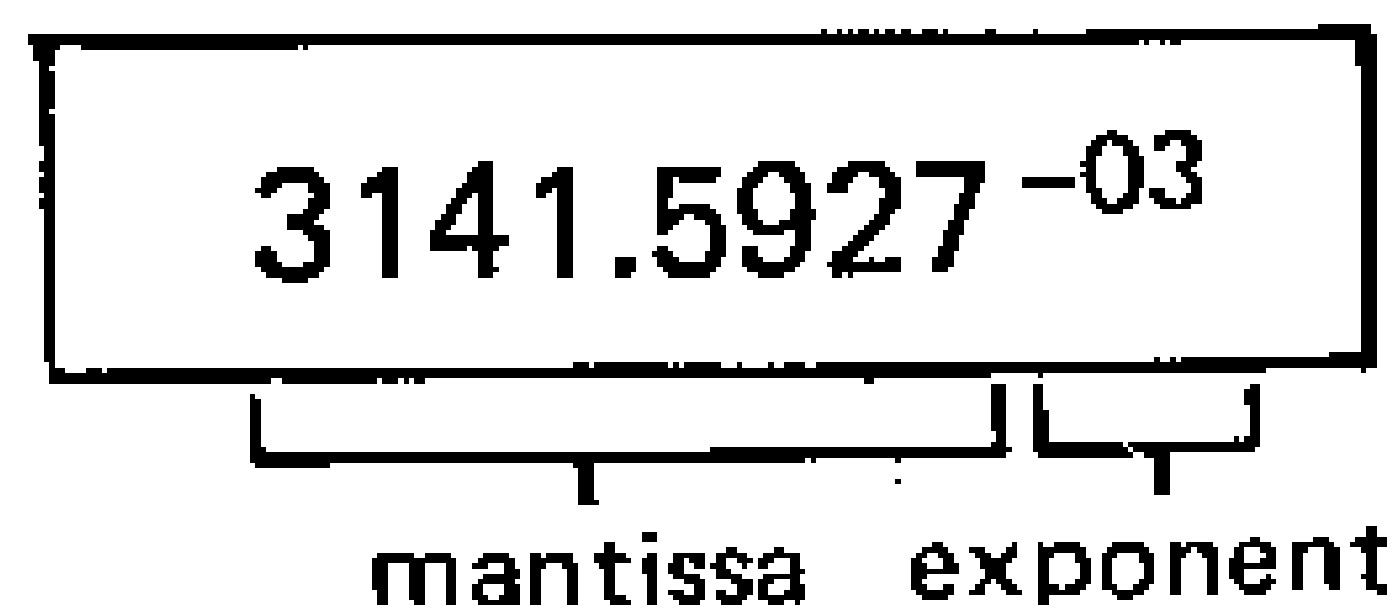

A sample display is shown above. The number on the display reads

$$3141.5927 \times 10^{-3}$$

Your calculator can compute numbers as large as

$$99999999 \times 10^{99}$$

and as small as

$$.00000001 \times 10^{-99}$$

Display Shut-Off Feature

To conserve battery power, the display has a timed shut-off feature. After 60 seconds of non-use, the displayed digits will disappear leaving only the decimal point. No information is lost and the calculations can continue at any time.

Press $\boxed{x \leftrightarrow y}$ twice to recall the number to the display.

Entry

Enter numbers exactly as they appear using the digit keys and the decimal key $\boxed{\cdot}$. To enter a negative number, press the change sign key $\boxed{+/-}$. The $\boxed{+/-}$ key will also change a negative number on the display to a positive one.

Scientific Form

Scientists usually express numbers in the following way:

$$6.023 \times 10^{23}$$

This is called *scientific form* and can be easily entered with the following steps.

- (1) Enter mantissa: 6.023
- (2) If the number is negative, press $\boxed{+/-}$
- (3) Enter exponent by pressing \boxed{EE} 23
- (4) If exponent is negative, press $\boxed{+/-}$

The Clear Key $\boxed{C/CE}$

If you make a mistake on entry, press $\boxed{C/CE}$ once. This will clear only the display and will leave the information stored in the registers. To clear all the registers (except the memories) press $\boxed{C/CE}$ twice.

The Inverse Key \boxed{INV}

The inverse key has properties similar to inverse functions in mathematics. As shown on page 13 it is used with the trig keys to calculate the inverse trigonometric functions. On page 14 we see \boxed{INV} is used with the degrees to radians key to convert radians to degrees. On page 15 the \boxed{INV} key is used with the polar to rectangular key to convert rectangular to polar coordinates.

On page 24, the \boxed{INV} key is used with the data entry key $\boxed{x_n}$ to delete an entry from an entered sample.

The Pi π Key

Press π to display

$$\pi = 3.1415927$$

II. Arithmetic Functions

Simple Arithmetic

The arithmetic keys $+$ $-$ \times \div $=$ are used to perform simple arithmetic exactly as written.

For example, to find $3 \times 4 =$, just press 3 \times 4 $=$ and the answer 12, appears on the display.

Any of the keys $+$ $-$ \times \div can be overridden by another. If you make a mistake, just reenter the correct one. For example, 3 $+$ \times 4 $=$ will ignore the $+$ and display 12.

Chaining

Two examples of chained operations are

$$3 \times 4 + 5 = \quad 8 - 4 \div 2 =$$

According to the rules of algebra, \times and \div supersede $+$ and $-$ and we get

$$\begin{aligned} 3 \times 4 + 5 &= (3 \times 4) + 5 & 8 - 4 \div 2 &= 8 - (4 \div 2) \\ &= 12 + 5 & &= 8 - 2 \\ &= 17 & &= 6 \end{aligned}$$

This is not the case with your new calculator.

Each time an arithmetic key is pressed, the preceding operation is performed and the result is displayed. Thus 8 $-$ 4 \div will display 4, the answer to $8 - 4$. If you then press 2 $=$, the calculator will perform $4 \div 2$ and display 2. Thus, the above operations on the calculator yield

$$\begin{aligned} 3 \times 4 + 5 &= 17 \\ 8 - 4 \div 2 &= 2 \end{aligned}$$

Chaining is useful because some complex expressions such as

$$(((3 + 2) \div 11) \times 44) - 6 =$$

can be entered without parentheses:

$$3 + 2 \div 11 \times 44 - 6 = 14$$

On the other hand, the following expression must be rearranged to be calculated without using parentheses.

$$\begin{aligned} 3 + (6 \times ((2 \times 12) \div 8)) &= \\ ((2 \times 12) \div 8) \times 6 + 3 &= \end{aligned}$$

$$2 \times 12 \div 8 \times 6 + 3 = 21$$

With a little practice, you will find that you can chain complex operations without having to re-write the expression on paper. You will quickly find that \times and $+$ give you no trouble but $-$ and \div present some problems. Try to calculate

$$2 - (4 \div (3 + 1))$$

It is for this reason we have the following key.

The $x \leftrightarrow y$ Key

In binary operations ($+$ $-$ \times \div y^x $\sqrt[y]{x}$) there are two numbers stored in the registers. For example, after pressing 3 $+$ 4, the y register contains 3 and the x register (the display) contains 4. When you press $x \leftrightarrow y$ the registers are switched.

You can use this feature to check a number already entered. For example, the number 6.626×10^{-27} is on the display and you press \div 9 but then remember you should have written down the previous number. Simply press $x \leftrightarrow y$ and the display reads 6.626^{-27} . You write this down, restore the registers by pressing $x \leftrightarrow y$ again and continue.

The major use of the $x \leftrightarrow y$ key however, is in chaining. Now, expressions like

$$2 - (4 \div (3 + 1))$$

can be calculated without parentheses:

$$3 + 1 \div 4 \times y - 2 \times y = 1$$

Parentheses

The parentheses keys $\boxed{\{ \}$ $\boxed{\} \}$ have the same functions as $()$ in algebra. For example, expressions like

- (i) $(3 + 4) \times (5 - 2) =$
 (ii) $2 \div (12 \div (3 + 9)) =$

can be computed exactly as written

- (i) $\boxed{\{ \} \} \} \boxed{3} \boxed{+} \boxed{4} \boxed{\} \} \boxed{\} \} \boxed{5} \boxed{-} \boxed{2} \boxed{\} \} \boxed{\} \} \boxed{\times} \boxed{=} \longrightarrow 21.$
- (ii) $\boxed{\{ \} \} \} \boxed{2} \boxed{\div} \boxed{\{ \} \} \} \boxed{12} \boxed{\div} \boxed{\{ \} \} \} \boxed{3} \boxed{+} \boxed{9} \boxed{\} \} \boxed{\} \} \boxed{\} \} \boxed{\} \} \boxed{=} \longrightarrow 2.$

There are two levels of parentheses. The expression (i) above uses one level, expression (ii) uses two levels.

The following expression uses three.

$$2 - (3 - (4 - (5 - 6)))$$

To compute expressions using more than two levels, the expression must be rearranged and chained as shown in the section on Chaining. Or the memories must be used.

The Percent Key $\boxed{\%}$

The percent key is used with the $\boxed{+}$ $\boxed{-}$ $\boxed{\times}$ $\boxed{\div}$ keys in the following way.

Enter	To Display
a $\boxed{+}$ b $\boxed{\%}$ $\boxed{=}$	a + (b% of a)
a $\boxed{-}$ b $\boxed{\%}$ $\boxed{=}$	a - (b% of a)
a $\boxed{\times}$ b $\boxed{\%}$ $\boxed{=}$	b% of a
a $\boxed{\div}$ b $\boxed{\%}$ $\boxed{=}$	x where a = b% of x

Example:

- (i) Increase 3.25 by 6%.
 (ii) Decrease 1.50 by 40%.
 (iii) 3% of 232 =
 (iv) 9 is 2% of what number

Solution:

- (i) $3.25 \boxed{+} 6 \boxed{\%} \boxed{=} \longrightarrow 3.445$
 (ii) $1.5 \boxed{-} 40 \boxed{\%} \boxed{=} \longrightarrow 0.9$
 (iii) $232 \boxed{\times} 3 \boxed{\%} \boxed{=} \longrightarrow 6.96$
 (iv) $9 \boxed{\div} 2 \boxed{\%} \boxed{=} \longrightarrow 450.$

III. Trigonometric Operators

The Angle Mode Key $\boxed{D/R/G}$

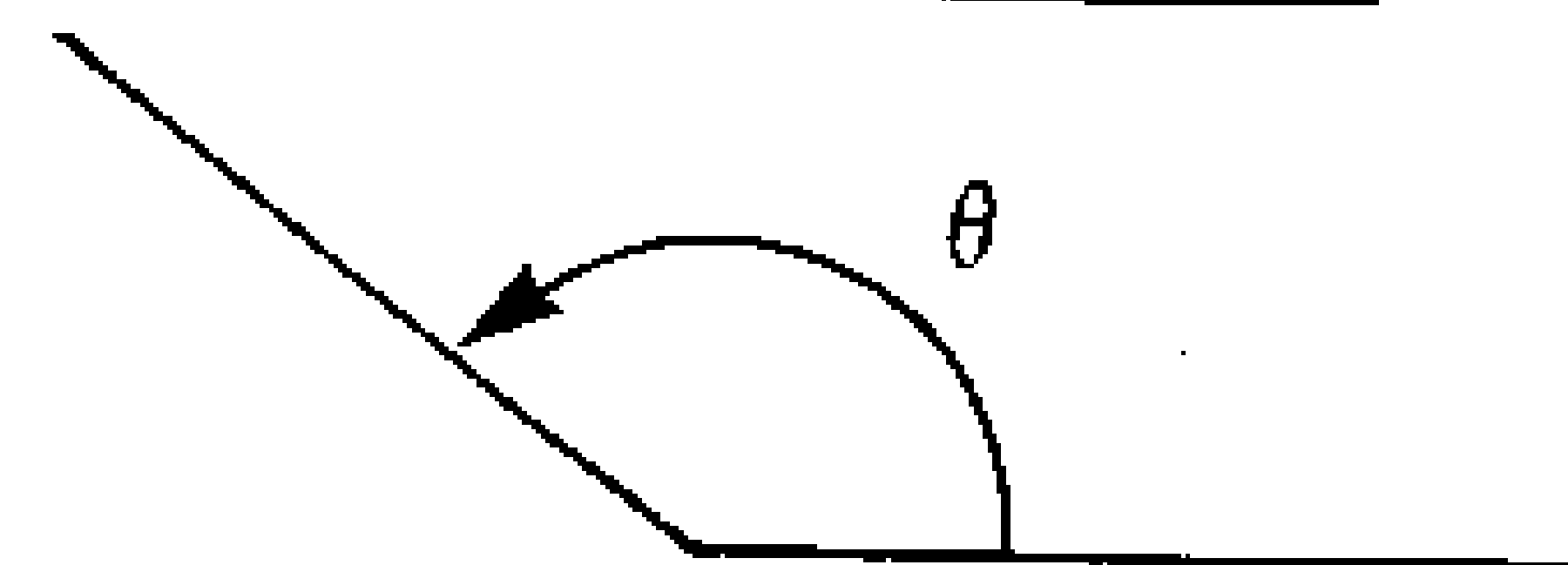

There are three units of measurement for angles

- 1 circle = 360 degrees
 = 2π radians
 = 400 gradians

Before using the trig keys, you must put the calculator in the right *angle mode*. That is, you must choose whether you want your entries and answers to be expressed in degrees, radians or gradians.

The machine is naturally operating in degree mode. Press $\boxed{D/R/G}$ once to enter the radian mode. Press $\boxed{D/R/G}$ again to enter gradian mode. If you press $\boxed{D/R/G}$ a third time, you will be back in degree mode.

To keep track of your modes, a dot is displayed to the right of the exponent for radian mode. A dot

is displayed to the left of the mantissa for gradian mode.

Examples:

3.1415927⁵²

Radian Mode

3.1415927⁵²

Gradian Mode

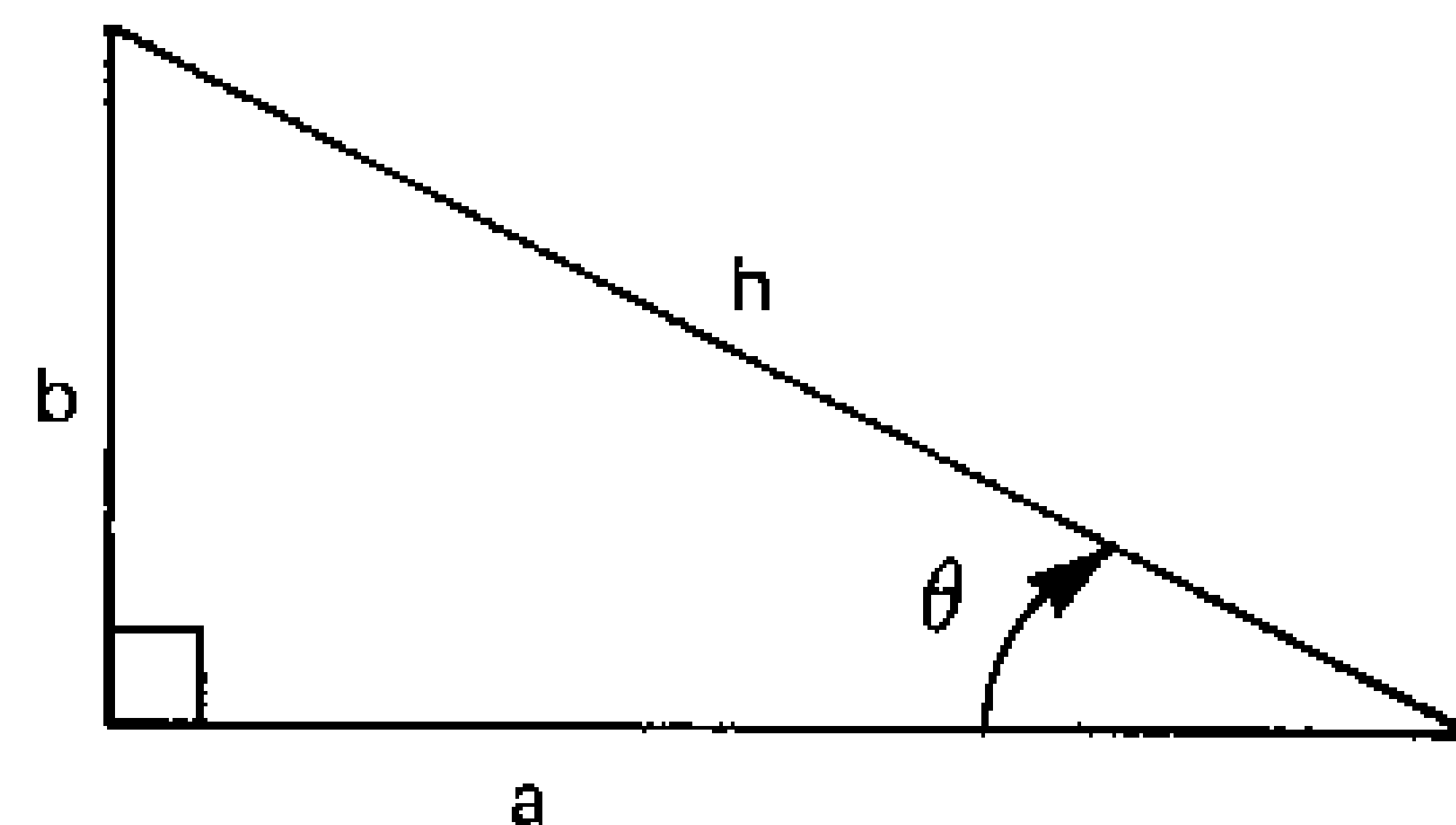

Trig Functions

The functions

$\sin \theta$

$\cos \theta$

are defined in the following diagram

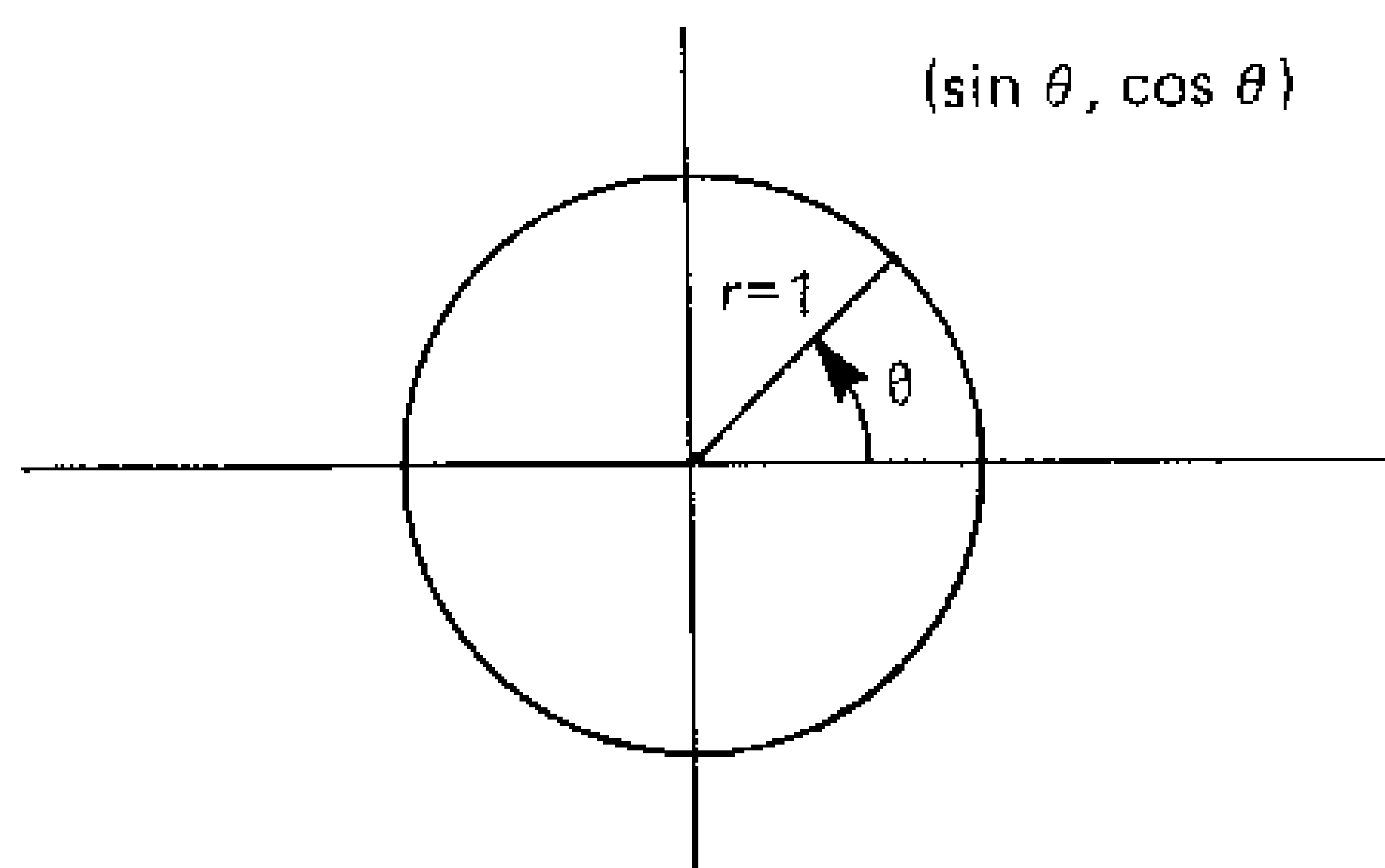

where $(\sin \theta, \cos \theta)$ are the rectangular coordinates of the indicated point.

The tangent is defined as

$$\tan \theta = \frac{\sin \theta}{\cos \theta}$$

The trig functions have the property that if

then

$$\sin \theta = \frac{b}{h} = \frac{\text{opposite}}{\text{hypotenuse}}$$

$$\cos \theta = \frac{a}{h} = \frac{\text{adjacent}}{\text{hypotenuse}}$$

$$\tan \theta = \frac{b}{a} = \frac{\text{opposite}}{\text{adjacent}}$$

The Trig Keys sin cos tan

The trig keys sin cos tan instantly compute the sine, cosine and tangent of the angle displayed. Remember to use D/R/G as explained in the previous section to put the calculator in the appropriate angle mode.

Example: Find x

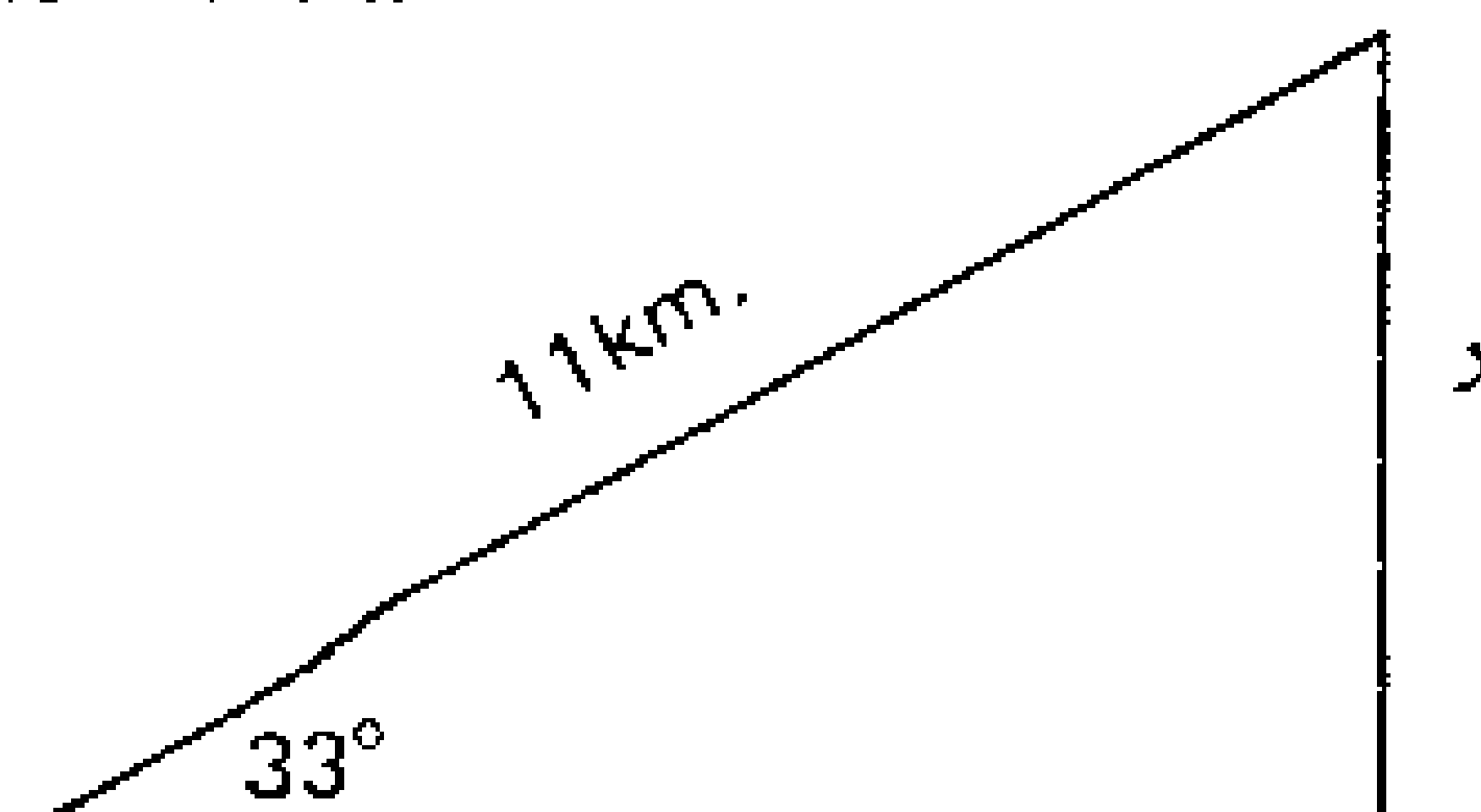

Solution:

$$\sin 33^\circ = \frac{x}{11 \text{ Km}}$$

$$\Rightarrow x = (\sin 33^\circ \times 11) \text{ Km}$$

$$33 \text{ [sin] [x] 11 [=]} \longrightarrow 5.9910294$$

Therefore,

$$x = 5.991 \text{ Km.}$$

Example: Find x

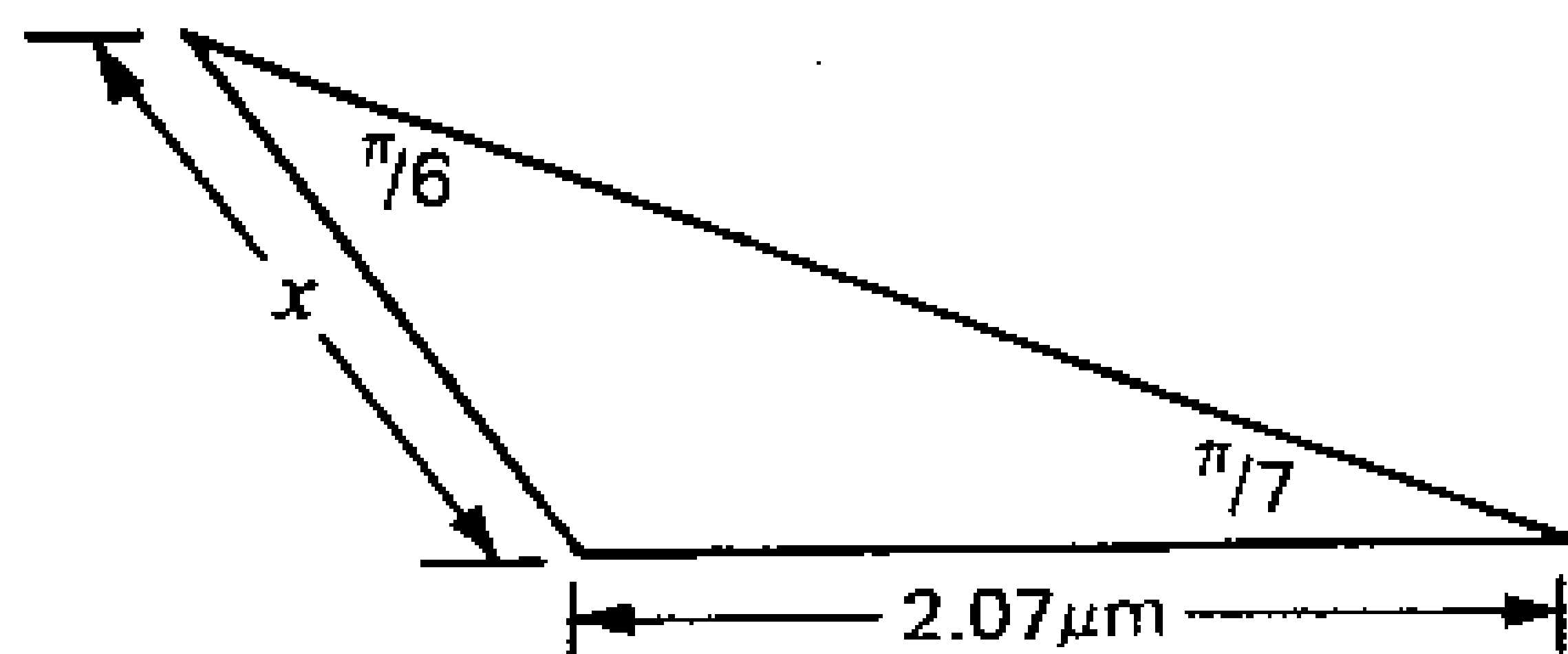

Solution: Use the law of sines (appendix F). We have

$$\frac{x}{\sin \frac{\pi}{7}} = \frac{2.07}{\sin \frac{\pi}{6}}$$

Hence,

$$x = \frac{2.07 \times \sin \frac{\pi}{7}}{\sin \frac{\pi}{6}}$$

The program is

$$\begin{array}{l} \text{[D/R/G]} \quad \text{(radians)} \\ \pi \text{ [÷] 7 [=] [sin]} \\ \text{[x] 2.07 [÷]} \\ \text{[(] [π] [÷] 6 [)] [sin] [=]} \longrightarrow 1.7962787 \end{array}$$

(The \cdot to the right indicates radian mode)

Hence,

$$x = 1.796 \mu\text{m}$$

The Inverse Trig Functions

The inverse trig functions are the reverse of the trig functions. The trig functions take an angle θ and give you a number x . The inverse trig functions take a number x and give you an angle θ .

The inverse sine, cosine and tangent are denoted

$$\sin^{-1} \quad \cos^{-1} \quad \tan^{-1}$$

and are defined by

$$\sin \theta = x \Leftrightarrow \theta = \sin^{-1} x \text{ and } -180^\circ \leq \theta \leq 180^\circ$$

$$\cos \theta = x \Leftrightarrow \theta = \cos^{-1} x \text{ and } 0 \leq \theta \leq 180^\circ$$

$$\tan \theta = x \Leftrightarrow \theta = \tan^{-1} x \text{ and } 0 < x$$

Inverse functions do the reverse operations of their associated functions. Thus we have

$$\sin^{-1} (\sin \theta) = \theta \quad \sin (\sin^{-1} x) = x$$

$$\cos^{-1} (\cos \theta) = \theta \quad \cos (\cos^{-1} x) = x$$

$$\tan^{-1} (\tan \theta) = \theta \quad \tan (\tan^{-1} x) = x$$

whenever θ and x fall within the above constraints.

To take the inverse sine of the number on display, press **[INV] [sin]**. The answer is an angle expressed in degrees, radians or gradians as indicated by the angle mode (page 9).

Similarly, to calculate \cos^{-1} and \tan^{-1} , press **[INV] [cos]** and **[INV] [tan]**.

Example: Find θ in radians

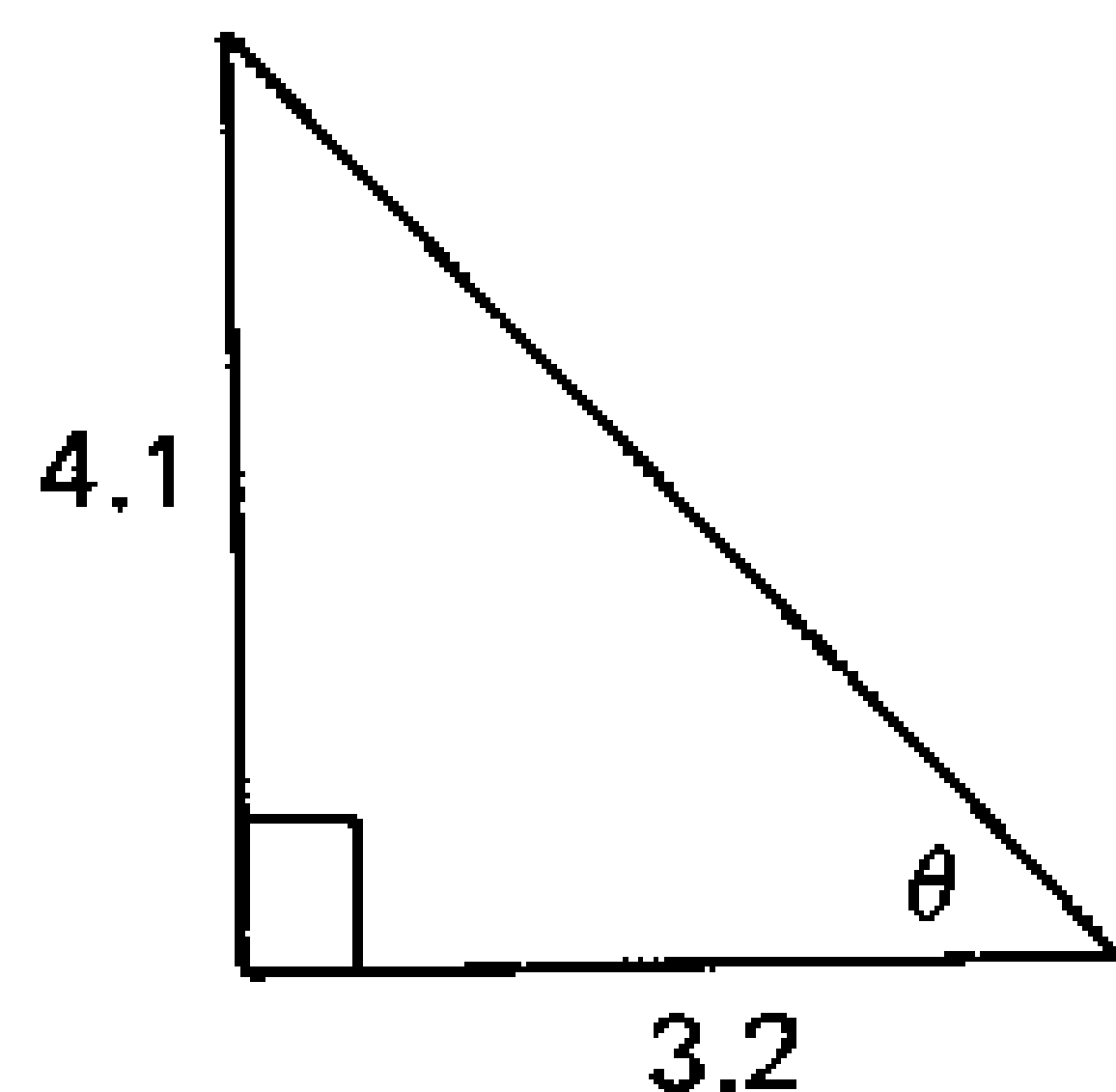

Solution: We have

$$\tan \theta = \frac{4.1}{3.2}$$

Therefore,

$$\theta = \tan^{-1} \left(\frac{4.1}{3.2} \right)$$

Thus,

$$\begin{array}{l} \boxed{\text{D/R/G}} \quad \boxed{\text{D/R/G}} \quad \text{(gradian mode)} \\ 4.1 \quad \boxed{\div} \quad 3.2 \quad \boxed{=} \\ \boxed{\text{INV}} \quad \boxed{\tan} \quad \longrightarrow \quad .57809329 \end{array}$$

So $\theta = 57.8$ gradians

Degrees/Radians Conversion

The $\boxed{\text{D} \rightarrow \text{R}}$ key will convert the displayed number from degree measure to radian measure (regardless of the angle mode). Similarly, $\boxed{\text{INV}} \quad \boxed{\text{D} \rightarrow \text{R}}$ will convert radians to degrees.

Example: Express in degrees

$$\theta = \cos^{-1} \left(\sin \frac{\pi}{3} \right)$$

Solution:

$$\begin{array}{l} \pi \quad \boxed{\div} \quad 3 \quad \boxed{=} \\ \boxed{\text{INV}} \quad \boxed{\text{D} \rightarrow \text{R}} \\ \quad \quad \quad \boxed{\sin} \\ \boxed{\text{INV}} \quad \boxed{\cos} \quad \longrightarrow \quad 30. \end{array}$$

Therefore,

$$\theta = 30^\circ$$

Notice that angles expressed in terms of π ($\frac{\pi}{3}$, $\frac{3\pi}{2}$, etc.) are assumed to be in radians.

Example: Express in radians

$$\theta = \tan^{-1} (\sin 11^\circ + \cos 15^\circ)$$

Solution:

$$\begin{array}{l} 11 \quad \boxed{\sin} \\ \quad \quad \quad \boxed{+} \\ 15 \quad \boxed{\cos} \\ \quad \quad \quad \boxed{=} \\ \boxed{\text{INV}} \quad \boxed{\tan} \\ \quad \quad \quad \boxed{\text{D} \rightarrow \text{R}} \quad \longrightarrow \quad 0.8579429 \\ \quad \quad \quad \boxed{\div} \quad \pi \quad \boxed{=} \quad \longrightarrow \quad 0.2730917 \end{array}$$

Thus,

$$\begin{aligned} \theta &= .86 \text{ radians} \\ &= .27\pi \text{ radians} \end{aligned}$$

Polar/Rectangular Coordinates

Polar

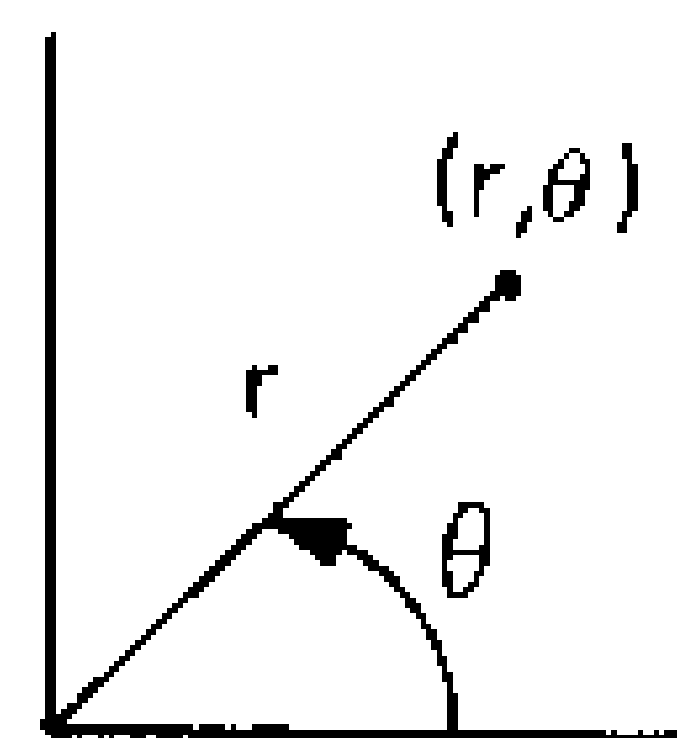

Rectangular

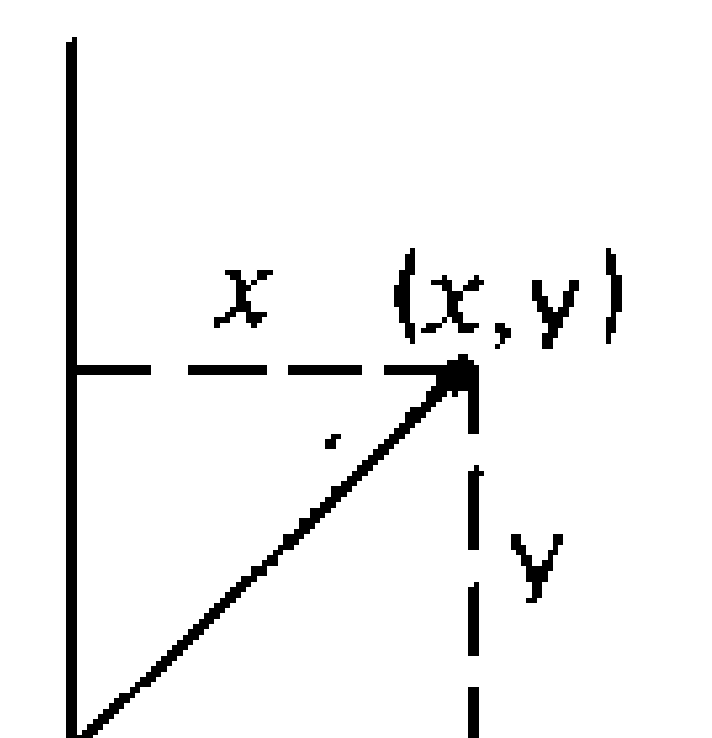

$$\begin{aligned} x &= r \cos \theta \\ y &= r \sin \theta \end{aligned}$$

The above equations show the relationship between polar and rectangular coordinates.

To convert (r, θ) to rectangular coordinates first enter $r \quad \boxed{x \leftrightarrow y} \quad \theta$ and then press $\boxed{\text{P} \rightarrow \text{R}}$ to display x . Press $\boxed{x \leftrightarrow y}$ to display y .

To convert (x, y) to polar coordinates, enter x $\boxed{x \leftrightarrow y}$ y and press \boxed{INV} $\boxed{P \rightarrow R}$. This displays r and $\boxed{x \leftrightarrow y}$ will then display θ .

The angle θ is expressed in the measure determined by the $\boxed{D/R/G}$ key.

Example: Convert to rectangular coordinates

- (i) $(3, 23^\circ)$
- (ii) $(1, \frac{\pi}{2})$
- (iii) $(4, 111 \text{ grads})$

Solution:

```

C/CE C/CE
  3 x ↔ y 23
    P → R → 2.7615146
    x ↔ y → 1.1721934
C/CE C/CE
    D/R/G (radian mode)
  1 x ↔ y ((  $\pi$  ÷ 2 ))
    P → R → 0.
    x ↔ y → 1.
C/CE C/CE
    D/R/G (gradian mode)
  4 x ↔ y 111
    P → R → -0.6877164
    x ↔ y → 3.9404373
  
```

Therefore, the three points are

- (i) $(2.76, 1.17)$
- (ii) $(0, 1)$
- (iii) $(-0.69, 3.94)$

IV. Algebraic Operators

$\boxed{x^2}$

Square Key

Press $\boxed{x^2}$ to square the displayed number.

$\boxed{\sqrt{x}}$

Square Root Key

Press $\boxed{\sqrt{x}}$ to take the square root of the displayed number.

$\boxed{1/x}$

Reciprocal Key

Press $\boxed{1/x}$ for the reciprocal of the displayed number.

Example: Find

$$w = \sqrt{\left(\frac{1}{x}\right)^2 + \left(\frac{1}{y}\right)^2 + \left(\frac{1}{z}\right)^2}$$

where $(x, y, z) = (3, 4, 5)$

Solution:

```

  3 1/x x2 +
  4 1/x x2 +
  5 1/x x2 =
    √x → 0.4621808
  
```

$\boxed{y^x}$

Power Key

To find a^b enter

a $\boxed{y^x}$ b $\boxed{=}$

$\boxed{\sqrt[x]{y}}$

Root Key

To find $b\sqrt[a]{a}$ enter

a $\boxed{\sqrt[x]{y}}$ b $\boxed{=}$

Note: With the $\boxed{y^x}$ and $\boxed{\sqrt[x]{y}}$ keys, parentheses cannot be used, the base a must be positive, and $\boxed{=}$ is used to complete the computation.

Example: Find

$$z = \sqrt[4]{((3)^{12})\pi}$$

Solution:

```

  3 yx 12 =
    yx  $\pi$  =
    √[x]{y} 41 = → 2.7460502
  
```

Thus $z = 2.75$

PROPERTIES OF EXPONENTS

- (i) $\sqrt[b]{a} = a^{\frac{1}{b}}$ (iv) $a^b \times a^c = a^{b+c}$
- (ii) $\frac{1}{a^b} = a^{-b}$ (v) $\frac{a^b}{a^c} = a^{b-c}$
- (iii) $a^0 = 1$ (vi) $(a^b)^c = a^{b \times c}$

Example: Find $\sqrt[7]{-4}$

Solution: You cannot use the $\boxed{y^x}$ and $\boxed{\sqrt[x]{y}}$ keys for negative bases. You must first rearrange this expression using the above identities.

$$\begin{aligned}\sqrt[7]{-4} &= (-4)^{\frac{1}{7}} \\ &= (-1 \times 4)^{\frac{1}{7}} \\ &= (-1)^{\frac{1}{7}} \times 4^{\frac{1}{7}} \\ &= \sqrt[7]{-1} \times \sqrt[7]{4} \\ &= -\sqrt[7]{4}\end{aligned}$$

Thus

$$4 \boxed{\sqrt[7]{y}} \boxed{7} \boxed{=} \boxed{+/-} \longrightarrow -1.2190137$$

V. Transcendental Operators

$\boxed{\ln}$ Natural Log Key

This key computes the natural log (ln) of the displayed number.

$\boxed{e^x}$ Natural Antilog Key

This key computes e^x for a displayed number x .

$\boxed{\log}$ Log Key

This key computes the log to the base 10 of the displayed number.

$\boxed{10^x}$ Antilogarithm Key

This key computes the antilog of the displayed number.

PROPERTIES OF TRANSCENDENTAL FUNCTIONS

The transcendental functions have the following properties:

- (i) $\ln a + \ln b = \ln (a \times b)$
- (ii) $\ln a - \ln b = \ln (a \div b)$
- (iii) $b \ln a = \ln (a^b)$
- (iv) $e^{\ln x} = x$
- (v) $\ln e^x = x$
- (vi) $\log a + \log b = \log (a \times b)$
- (vii) $\log a - \log b = \log (a \div b)$
- (viii) $b \log a = \log (a^b)$
- (ix) $10^{\log x} = x$
- (x) $\log 10^x = x$

Example: A colony of bacteria has the following population formula:

$$n = 3.6 \times 10^{2t} + 4.9 \times 10^4$$

Here the number of organisms, n , is determined by the number of days, t . How long will it take the population to reach 100 million?

Solution: Solve for t

$$\begin{aligned}3.6 \times 10^{2t} + 4.9 \times 10^4 &= 10^8 \\ \Rightarrow 3.6 \times 10^{2t} &= 10^8 - (4.9 \times 10^4) \\ \Rightarrow 10^{2t} &= \frac{10^8 - (4.9 \times 10^4)}{3.6}\end{aligned}$$

Take the log of both sides

$$\log 10^{2t} = \log \left(\frac{10^8 - (4.9 \times 10^4)}{3.6} \right)$$

By property (ix), above,

$$\log 10^{2t} = 2t$$

Therefore,

$$t = \frac{1}{2} \log \left(\frac{10^8 - (4.9 \times 10^4)}{3.6} \right)$$

Now, compute t

$$\begin{array}{l} 1 \text{ [EE] } 8 \text{ [-]} \\ 4.9 \text{ [EE] } 4 \text{ [÷]} \\ \quad 3.6 \text{ [=]} \\ \quad \text{[log]} \\ \quad \text{[÷]} 2 \text{ [=]} \longrightarrow 3.7217423 \\ \text{[-]} 3 \text{ [x] } 24 \text{ [=]} \longrightarrow 17.321816 \end{array}$$

Thus, it will take approximately 3 days and 17 hours to reach a population of 100 million.

VI. Memories

There are three memories labeled

0, 1, 2

Operations for the n memory (n = 0, 1 and 2) are made with the following keys:

[STO] **Store Key**
To store the displayed number in memory n, press **[STO]** n. This will override the previous entry in memory n.

[RCL] **Recall Key**
Press **[RCL]** n to display the contents of memory 'n'.

[M+] **Add to Memory**
Press **[M+]** n to add the displayed number to the number stored in memory n. The result is then stored in memory n.

[Mx] **Multiply by Memory**

Press **[Mx]** n to multiply the displayed number by the number stored in memory n. The result is then stored in memory n.

[XCH] **Memory Exchange**

To display the contents of memory n and at the same time store the displayed number in memory n, simply press **[XCH]** n.

Note: Each time one of the above keys is used, it must be immediately followed by 0, 1 or 2 to indicate which memory is used.

Example: Solve for x

$$3x^2 - 5x + 1 = 0$$

Solution: Use the quadratic formula

$$x = \frac{-b \pm \sqrt{b^2 - 4ac}}{2a}$$

$$\begin{array}{l} 3 \text{ [STO] } 0 \quad (a) \\ 5 \text{ [+/-] [STO] } 1 \quad (b) \\ 1 \text{ [STO] } 2 \quad (c) \\ \text{[RCL] } 1 \text{ [x}^2 \text{] [-]} \\ \text{[(] } 4 \text{ [x] [RCL] } 0 \text{ [x] [RCL] } 2 \text{ [)]]} \\ \text{[=]} \quad (b^2 - 4ac) \\ \text{[√x]} \quad (\sqrt{b^2 - 4ac}) \\ \text{[STO] } 2 \\ \text{[RCL] } 1 \text{ [+/-] [-] [RCL] } 2 \\ \text{[÷] [(] } 2 \text{ [x] [RCL] } 0 \text{ [)]] [=]} \rightarrow 0.2324081 \\ \text{[RCL] } 1 \text{ [+/-] [+] [RCL] } 2 \\ \text{[÷] [(] } 2 \text{ [x] [RCL] } 0 \text{ [)]] [=]} \rightarrow 1.4342585 \end{array}$$

Thus $x = .23$ or $x = 1.43$

Example: Factor

471, 339

Solution:

471339 **STO** 1
÷ 2 **=** → 235669.5
RCL 1 **÷** 3 **=** → 157113.
STO 1 **÷** 3 **=** → 52371.
STO 1 **÷** 3 **=** → 17457.
STO 1 **÷** 3 **=** → 5819.
STO 1 **÷** 3 **=** → 1939.6667
RCL 1 **÷** 5 **=** → 1163.8
RCL 1 **÷** 7 **=** → 831.28571
RCL 1 **÷** 11 **=** → 529.
STO 1 **÷** 11 **=** → 48.090909
RCL 1 **÷** 13 **=** → 40.692308
RCL 1 **÷** 17 **=** → 31.117647
RCL 1 **÷** 19 **=** → 27.842105
RCL 1 **÷** 23 **=** → 23.

Therefore $471339 = 3 \times 3 \times 3 \times 3 \times 11 \times 23 \times 23$
 $= 3^4 \times 11 \times 23^2$

Example: Compute

$$\frac{1}{1!} + \frac{1}{2!} + \frac{1}{3!} + \frac{1}{4!} + \frac{1}{5!} + \frac{1}{6!}$$

Solution:

1 **STO** 0
1 **STO** 1
2 **Mx** 0
RCL 0 **1/x** **M+** 1
3 **Mx** 0
RCL 0 **1/x** **M+** 1
4 **Mx** 0
RCL 0 **1/x** **M+** 1
5 **Mx** 0
RCL 0 **1/x** **M+** 1
6 **Mx** 0
RCL 0 **1/x** **M+** 1
RCL 1 → 1.7180556

VII. Statistical Operators

Given a sample of observed values

$$x_1, x_2, \dots, x_n$$

the calculator will evaluate the **sample mean**:

$$\bar{x} = \frac{\sum x_i}{n}$$

the **standard deviations**

$$s = \sqrt{\frac{\sum (x_i - \bar{x})^2}{n - 1}}$$

$$s' = \sqrt{\frac{\sum (x_i - \bar{x})^2}{n}}$$

the **sum of entries**

$$\sum x_i$$

and the **sum of squares**

$$\sum x_i^2$$

Appendix A contains useful statistical tests. The Normal distribution is in Appendix B and the Student's distribution is in Appendix C.

The Statistical Keys

x_n **Data Entry:** To enter a sample 5, 9, 11, 21 press 5 x_n 9 x_n 11 x_n 21 x_n . To delete 11 from this sample press 11 **INV** x_n . Each time x_n is pressed, the number of points entered so far is displayed.

\bar{x} **Sample Mean:** Press \bar{x} for the sample mean once the data has been entered.

s **s'** **Standard Deviation:** Press s or s' for the unbiased and biased standard deviations as defined above.

n **Number of Entries:** The number of points entered, n , is stored in memory 0.

Σx_i **Sum of Entries:** The sum of entries is stored in memory 1.

Σx_i^2 **Sum of Squares:** The sum of squares is stored in memory 2.

Important: Memories cannot be used during statistical computations. Before beginning statistical computations, all three memories must be cleared by switching the machine off and on or by entering 0 into all three memories.

Confidence Intervals

Example: A new laboratory technique to synthesize a rare chemical compound has resulted in the following yields in grams.

0.47	0.44	0.62
0.51	0.53	0.50
0.69	0.49	0.55

Find the 95% confidence interval for the average yield for the new process.

Solution: First, find \bar{x} and s_x

$$\begin{array}{lll} .47 & x_n & .44 & x_n & .62 & x_n \\ .51 & x_n & .53 & x_n & .50 & x_n \\ .69 & x_n & .49 & x_n & .55 & x_n \end{array}$$

$$\bar{x} \longrightarrow 0.5333333$$

$$s \longrightarrow 7.7942286^{-02}$$

By test 3, Appendix A, the value

$$t = \frac{\bar{x} - m_{\bar{x}}}{s_{\bar{x}}}$$

satisfies a t distribution with 8 degrees of freedom where

$$m_{\bar{x}} = m_x$$

$$\begin{aligned} s_{\bar{x}} &= \frac{s_x}{\sqrt{n}} \\ &= \frac{7.7942286 \times 10^{-2}}{\sqrt{9}} \\ &= 2.5980762 \times 10^{-2} \end{aligned}$$

Let the confidence interval be

$$[.533 - \Delta, .533 + \Delta]$$

At best, the average yield $m_x = .533 + \Delta$ and we have

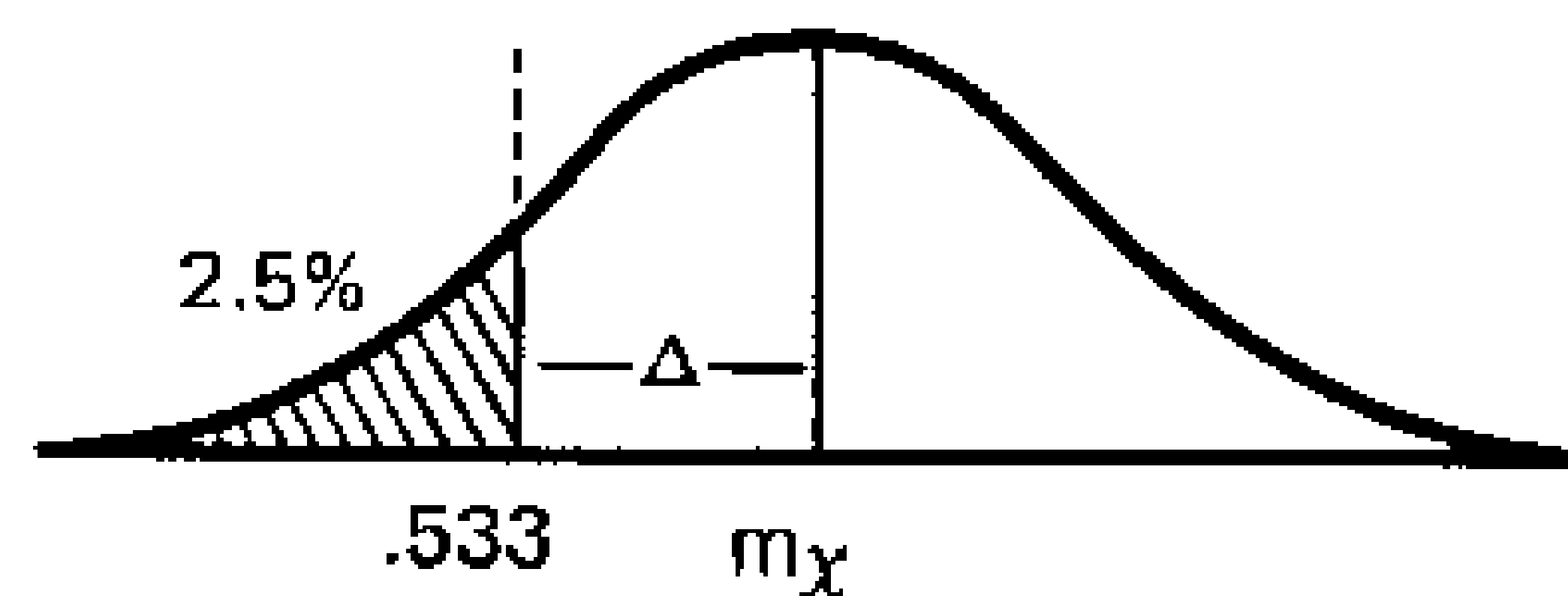

At worst, $m_x = .533 - \Delta$ and we have

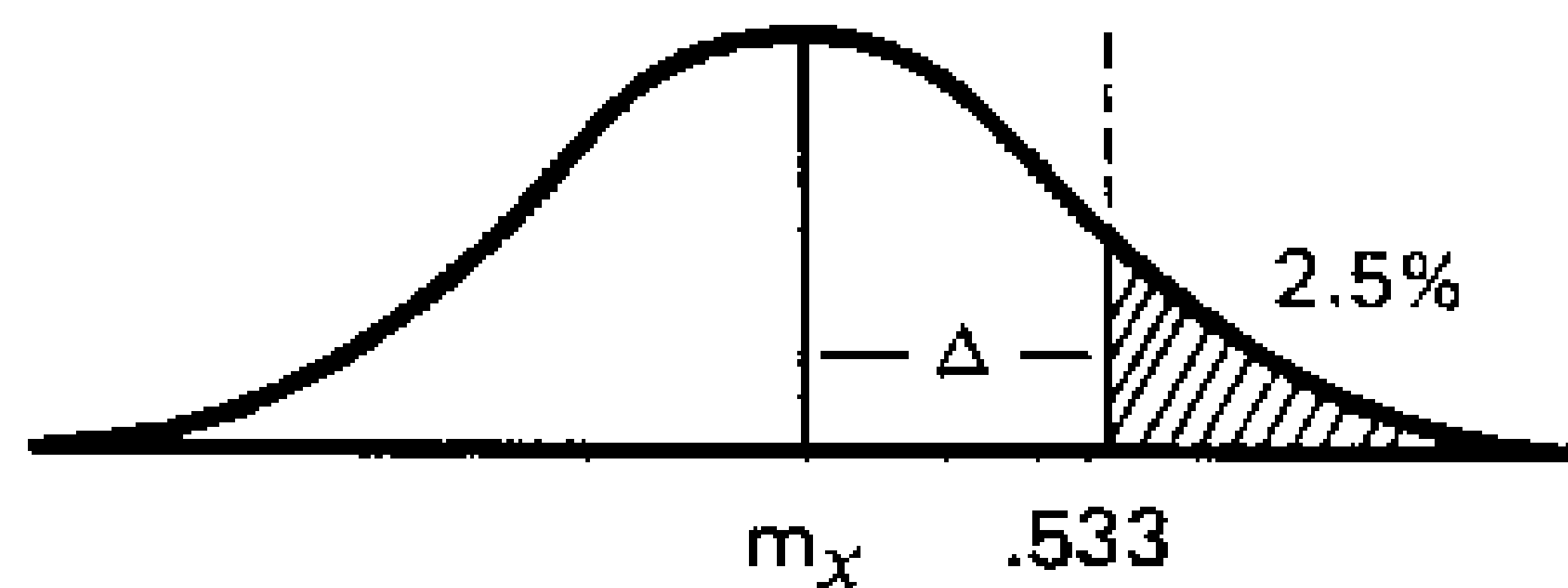

Consider the case where

$$m_x = .533 - \Delta$$

We have

$$t = \frac{.533 - (.533 - \Delta)}{2.5980762 \times 10^{-2}}$$

$$= \frac{\Delta}{2.5980762 \times 10^{-2}}$$

Next, from Appendix C we have

$$t_{.975} = 2.31$$

Therefore,

$$\Delta = 2.31 \times 2.5980762 \times 10^{-2}$$

$$= 0.0600$$

Therefore,

$$.533 + \Delta = .593$$

$$.533 - \Delta = .473$$

We are 95% certain that the average yield is between .47 and .59 grams.

Hypothesis Testing

Example: Two varieties of corn are grown in adjacent plots at 10 different locations. The yields in pounds are:

Location	Variety A	Variety B
1	135	131
2	120	112
3	108	102
4	105	107
5	126	121
6	122	125
7	110	110
8	115	111
9	110	105
10	118	117

Are the variety means significantly different at the 95% level?

Solution: Let x denote variety A
 y denote variety B

Then $d = x - y$ is the difference in weight of the two varieties at each location.

From test 5, Appendix A, the values

$$t = \frac{\bar{d} - m\bar{d}}{s\bar{d}}$$

satisfy a t distribution with 9 degrees of freedom where

$$m\bar{d} = m\bar{d} = m_x - m_y$$

$$s\bar{d} = \frac{sd}{\sqrt{n}} = \frac{sd}{\sqrt{10}}$$

We test the hypothesis

$$H_0: m_x = m_y$$

From above, we get

$$H_0: m\bar{d} = 0$$

The alternate hypothesis is

$$H_1: m_x > m_y$$

This indicates a 1 tailed test.

Compute \bar{d} and s_d .

135	-	131	=	x_n
120	-	112	=	x_n
108	-	102	=	x_n
105	-	107	=	x_n
126	-	121	=	x_n
122	-	125	=	x_n
110	-	110	=	x_n
115	-	111	=	x_n
110	-	105	=	x_n
118	-	117	=	x_n
				\bar{x}
				s

→ 2.8

→ 3.6147845

Thus

$$t = \frac{2.8 - 0.0}{\left(\frac{3.6147845}{\sqrt{10}}\right)}$$
$$= 2.4494897$$

From Appendix C, using 9 degrees of freedom,

$$t_{.95} = 1.83$$

We have

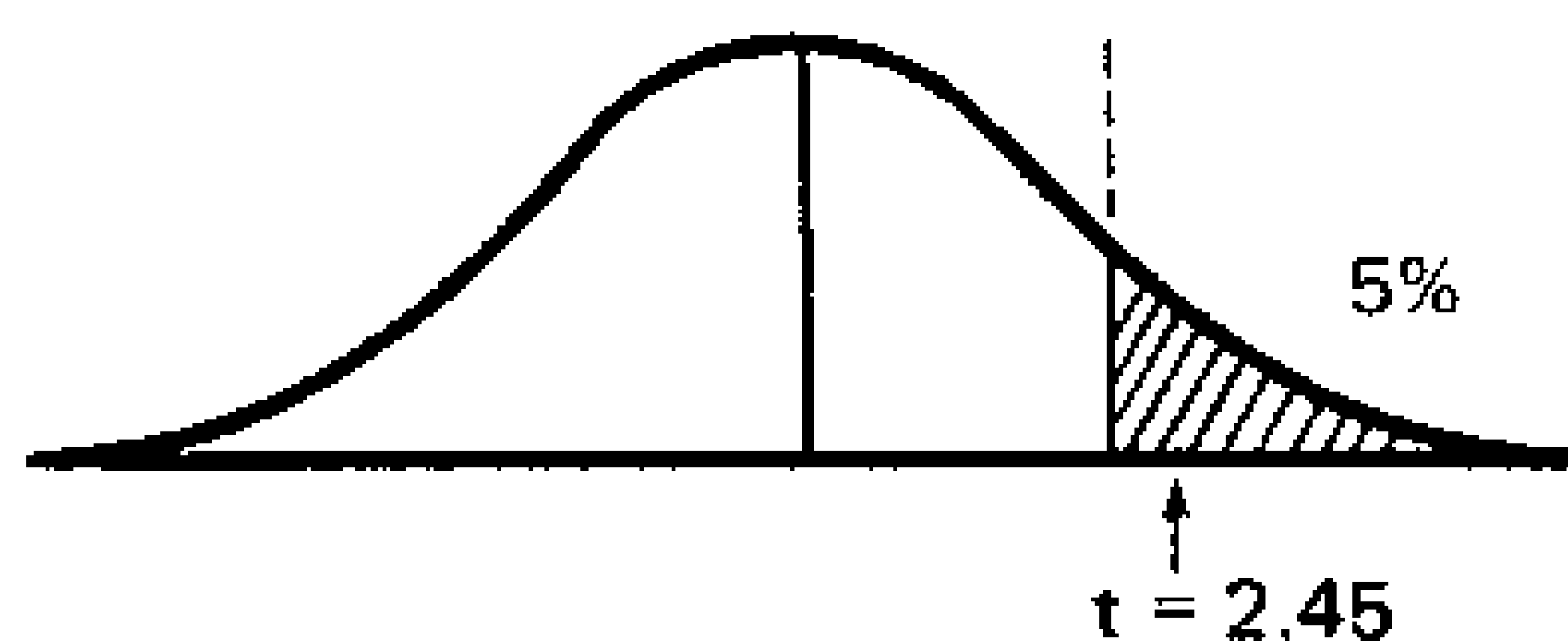

This is a significant difference. Variety A has a higher yield than Variety B.

Appendices

Appendix A. Statistical Tests

Test Variate	Assumptions	Distribution	Transformation	Values
1 \bar{x}	x normal or $n \geq 30$	normal	$z = \frac{\bar{x} - m_{\bar{x}}}{\sigma_{\bar{x}}}$	$m_{\bar{x}} = m_x$ $\sigma_{\bar{x}} = \frac{\sigma_x}{\sqrt{n}}$
2 $\bar{x} - \bar{y}$	x,y normal, independent	normal	$z = \frac{(\bar{x} - \bar{y}) - m_{\bar{x} - \bar{y}}}{\sigma_{\bar{x} - \bar{y}}}$	$m_{\bar{x} - \bar{y}} = m_x - m_y$ $\sigma_{\bar{x} - \bar{y}} = \sqrt{\sigma_x^2 + \sigma_y^2}$ where $\sigma_x = \frac{\sigma_x}{\sqrt{n_x}}$ $\sigma_y = \frac{\sigma_y}{\sqrt{n_y}}$
3 \bar{x}	x normal $n < 30$	t (n - 1) df	$t = \frac{\bar{x} - m_{\bar{x}}}{s_{\bar{x}}}$	$m_{\bar{x}} = m_x$ $s_{\bar{x}} = \frac{s_x}{\sqrt{n}}$
4 $\bar{x} - \bar{y}$	x,y normal, independent	t ($n_x + n_y - 2$) df	$t = \frac{(\bar{x} - \bar{y}) - m_{\bar{x} - \bar{y}}}{s_{\bar{x} - \bar{y}}}$	$m_{\bar{x} - \bar{y}} = m_x - m_y$ $s_{\bar{x} - \bar{y}} = \sqrt{s_x^2 + s_y^2}$ where $s_x = \frac{s}{\sqrt{n_x}}$ $s_y = \frac{s}{\sqrt{n_y}}$ $s = \sqrt{\frac{\sum(x - \bar{x})^2 + \sum(y - \bar{y})^2}{n_x + n_y - 2}}$
5 $\bar{d} = \overline{x - y}$	x,y normal paired	t (n - 1) df	$t = \frac{\bar{d} - m_{\bar{d}}}{s_{\bar{d}}}$	$s_{\bar{d}} = \frac{s_d}{\sqrt{n}} = \frac{s_{x-y}}{\sqrt{n}}$ $m_{\bar{d}} = m_d = m_x - m_y$

Appendix B. Areas under the Standard Normal Curve from 0 to z

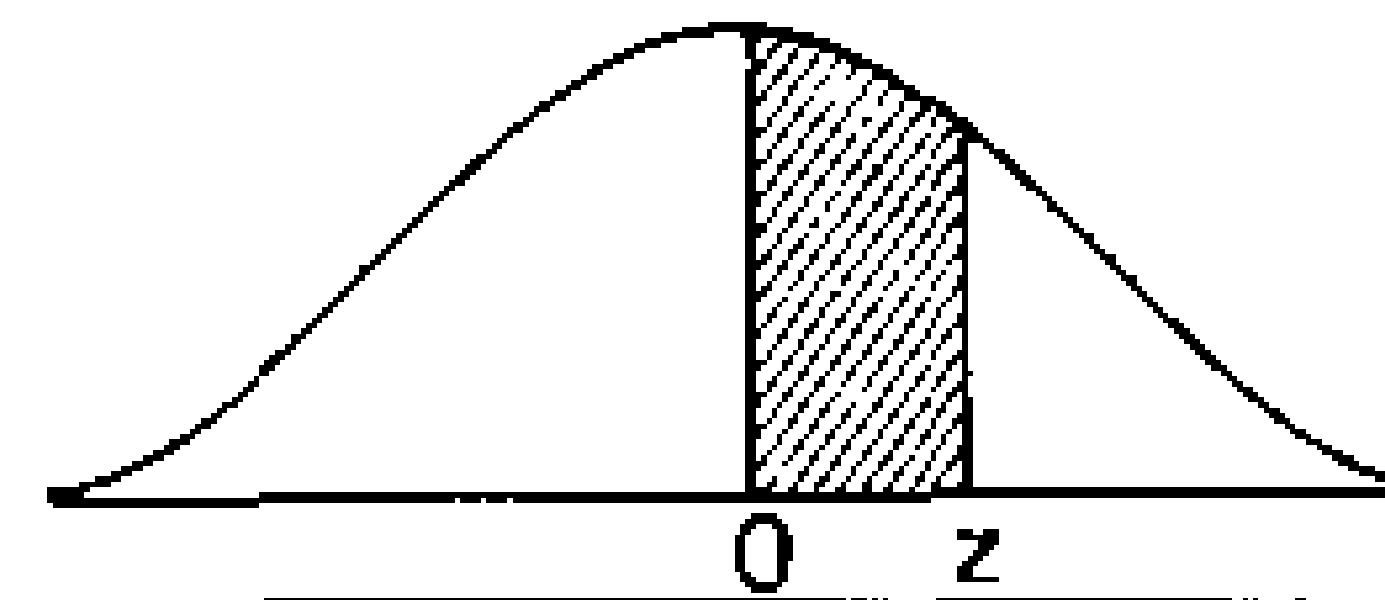

z	0	1	2	3	4	5	6	7	8	9
0.0	.0000	.0040	.0080	.0120	.0160	.0199	.0239	.0279	.0319	.0359
0.1	.0398	.0438	.0478	.0517	.0557	.0596	.0636	.0675	.0714	.0754
0.2	.0793	.0832	.0871	.0910	.0948	.0987	.1026	.1064	.1103	.1141
0.3	.1179	.1217	.1255	.1293	.1331	.1368	.1406	.1443	.1480	.1517
0.4	.1554	.1591	.1628	.1664	.1700	.1736	.1772	.1808	.1844	.1879
0.5	.1915	.1950	.1985	.2019	.2054	.2088	.2123	.2157	.2190	.2224
0.6	.2258	.2291	.2324	.2357	.2389	.2422	.2454	.2486	.2518	.2549
0.7	.2580	.2612	.2642	.2673	.2704	.2734	.2764	.2794	.2823	.2852
0.8	.2881	.2910	.2939	.2967	.2996	.3023	.3051	.3078	.3106	.3133
0.9	.3159	.3186	.3212	.3238	.3264	.3289	.3315	.3340	.3365	.3389
1.0	.3413	.3438	.3461	.3485	.3508	.3531	.3554	.3577	.3599	.3621
1.1	.3643	.3665	.3686	.3708	.3729	.3749	.3770	.3790	.3810	.3830
1.2	.3849	.3869	.3888	.3907	.3925	.3944	.3962	.3980	.3997	.4015
1.3	.4032	.4049	.4066	.4082	.4099	.4115	.4131	.4147	.4162	.4177
1.4	.4192	.4207	.4222	.4236	.4251	.4265	.4279	.4292	.4306	.4319
1.5	.4332	.4345	.4357	.4370	.4382	.4394	.4406	.4418	.4429	.4441
1.6	.4452	.4463	.4474	.4484	.4495	.4505	.4515	.4525	.4535	.4545
1.7	.4554	.4564	.4573	.4582	.4591	.4599	.4608	.4616	.4625	.4633
1.8	.4641	.4649	.4656	.4664	.4671	.4678	.4686	.4693	.4699	.4706
1.9	.4713	.4719	.4726	.4732	.4738	.4744	.4750	.4756	.4761	.4767
2.0	.4772	.4778	.4783	.4788	.4793	.4798	.4803	.4808	.4812	.4817
2.1	.4821	.4826	.4830	.4834	.4838	.4842	.4846	.4850	.4854	.4857
2.2	.4861	.4864	.4868	.4871	.4875	.4878	.4881	.4884	.4887	.4890
2.3	.4893	.4896	.4898	.4901	.4904	.4906	.4909	.4911	.4913	.4916
2.4	.4918	.4920	.4922	.4925	.4927	.4929	.4931	.4932	.4934	.4936
2.5	.4938	.4940	.4941	.4943	.4945	.4946	.4948	.4949	.4951	.4952
2.6	.4953	.4955	.4956	.4957	.4959	.4960	.4961	.4962	.4963	.4964
2.7	.4965	.4966	.4967	.4968	.4969	.4970	.4971	.4972	.4973	.4974
2.8	.4974	.4975	.4976	.4977	.4977	.4978	.4979	.4979	.4980	.4981
2.9	.4981	.4982	.4982	.4983	.4984	.4984	.4985	.4985	.4986	.4986
3.0	.4987	.4987	.4987	.4988	.4988	.4989	.4989	.4989	.4990	.4990
3.1	.4990	.4991	.4991	.4991	.4992	.4992	.4992	.4992	.4993	.4993
3.2	.4993	.4993	.4994	.4994	.4994	.4994	.4994	.4995	.4995	.4995
3.3	.4995	.4995	.4995	.4996	.4996	.4996	.4996	.4996	.4996	.4997
3.4	.4997	.4997	.4997	.4997	.4997	.4997	.4997	.4997	.4997	.4998
3.5	.4998	.4998	.4998	.4998	.4998	.4998	.4998	.4998	.4998	.4998
3.6	.4998	.4998	.4999	.4999	.4999	.4999	.4999	.4999	.4999	.4999
3.7	.4999	.4999	.4999	.4999	.4999	.4999	.4999	.4999	.4999	.4999
3.8	.4999	.4999	.4999	.4999	.4999	.4999	.4999	.4999	.4999	.4999
3.9	.5000	.5000	.5000	.5000	.5000	.5000	.5000	.5000	.5000	.5000

**Appendix C. Percentile Values (t_p)
for Student's t Distribution with
 v Degrees of Freedom**

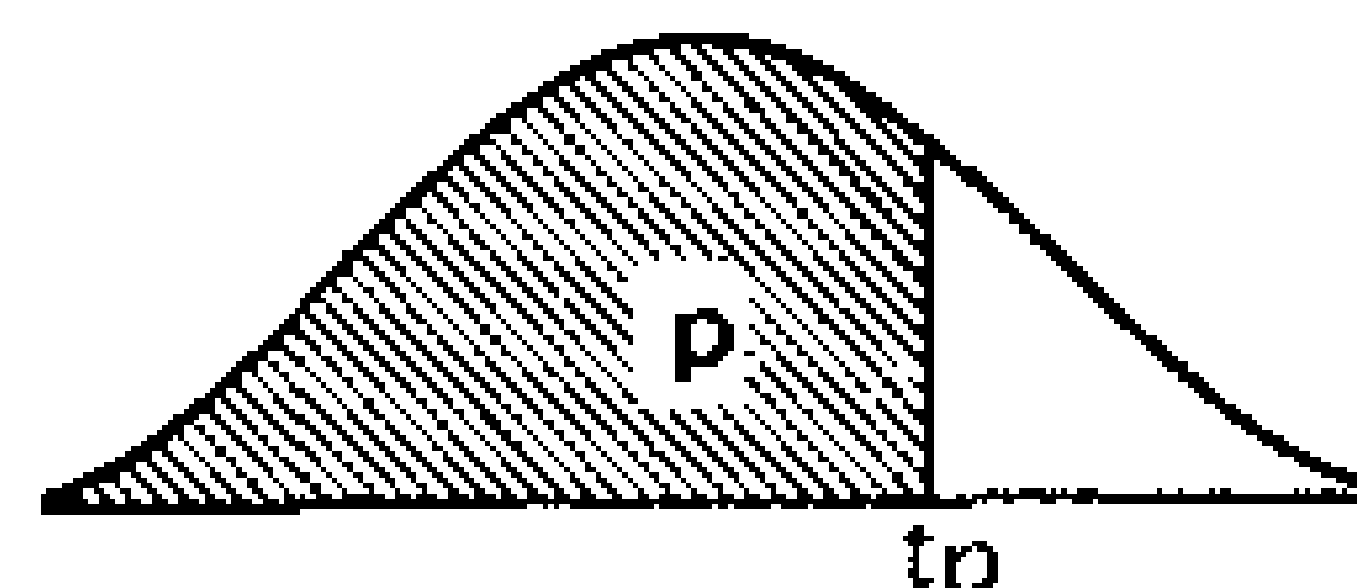

v	$t_{.55}$	$t_{.60}$	$t_{.70}$	$t_{.75}$	$t_{.80}$	$t_{.90}$	$t_{.95}$	$t_{.975}$	$t_{.99}$	$t_{.995}$
1	.158	.325	.727	1.000	1.376	3.08	6.31	12.71	31.82	63.66
2	.142	.289	.617	.816	1.061	1.89	2.92	4.30	6.96	9.92
3	.137	.277	.584	.765	.978	1.64	2.35	3.18	4.54	5.84
4	.134	.271	.569	.741	.941	1.53	2.13	2.78	3.75	4.60
5	.132	.267	.559	.727	.920	1.48	2.02	2.57	3.36	4.03
6	.131	.265	.553	.718	.906	1.44	1.94	2.45	3.14	3.71
7	.130	.263	.549	.711	.896	1.42	1.90	2.36	3.00	3.50
8	.130	.262	.546	.706	.889	1.40	1.86	2.31	2.90	3.36
9	.129	.261	.543	.703	.883	1.38	1.83	2.26	2.82	3.25
10	.129	.260	.542	.700	.879	1.37	1.81	2.23	2.76	3.17
11	.129	.260	.540	.697	.876	1.36	1.80	2.20	2.72	3.11
12	.128	.259	.539	.695	.873	1.36	1.78	2.18	2.68	3.06
13	.128	.259	.538	.694	.870	1.35	1.77	2.16	2.65	3.01
14	.128	.258	.537	.692	.868	1.34	1.76	2.14	2.62	2.98
15	.128	.258	.536	.691	.866	1.34	1.75	2.13	2.60	2.95
16	.128	.258	.535	.690	.865	1.34	1.75	2.12	2.58	2.92
17	.128	.257	.534	.689	.863	1.33	1.74	2.11	2.57	2.90
18	.127	.257	.534	.688	.862	1.33	1.73	2.10	2.55	2.88
19	.127	.257	.533	.688	.861	1.33	1.73	2.09	2.54	2.86
20	.127	.257	.533	.687	.860	1.32	1.72	2.09	2.53	2.84
21	.127	.257	.532	.686	.859	1.32	1.72	2.08	2.52	2.83
22	.127	.256	.532	.686	.858	1.32	1.72	2.07	2.51	2.82
23	.127	.256	.532	.685	.858	1.32	1.71	2.07	2.50	2.81
24	.127	.256	.531	.685	.857	1.32	1.71	2.06	2.49	2.80
25	.127	.256	.531	.684	.856	1.32	1.71	2.06	2.48	2.79
26	.127	.256	.531	.684	.856	1.32	1.71	2.06	2.48	2.78
27	.127	.256	.531	.684	.855	1.31	1.70	2.05	2.47	2.77
28	.127	.256	.530	.683	.855	1.31	1.70	2.05	2.47	2.76
29	.127	.256	.530	.683	.854	1.31	1.70	2.04	2.46	2.76
30	.127	.256	.530	.683	.854	1.31	1.70	2.04	2.46	2.75
40	.126	.255	.529	.681	.851	1.30	1.68	2.02	2.42	2.70
60	.126	.254	.527	.679	.848	1.30	1.67	2.00	2.39	2.66
120	.126	.254	.526	.677	.845	1.29	1.66	1.98	2.36	2.62
∞	.126	.253	.524	.674	.842	1.28	1.645	1.96	2.33	2.58

Appendix D. Derivatives

General

$$\frac{d(c)}{dx} = 0$$

$$\frac{d(u+v)}{dx} = \frac{du}{dx} + \frac{dv}{dx}$$

$$\frac{d(x^n)}{dx} = nx^{n-1}$$

$$\frac{d(u \cdot v)}{dx} = u \frac{dv}{dx} + v \frac{du}{dx}$$

$$\frac{d(cu)}{dx} = c \frac{du}{dx}$$

$$\frac{d(u/v)}{dx} = \frac{v \left(\frac{du}{dx}\right) - u \left(\frac{dv}{dx}\right)}{v^2}$$

$$\text{(Chain Rule)} \quad \frac{dz}{dx} = \frac{dz}{dy} \times \frac{dy}{dx}$$

Trigonometric

$$\frac{d(\sin x)}{dx} = \cos x$$

$$\frac{d(\sin^{-1} x)}{dx} = \frac{1}{\sqrt{1-x^2}}$$

$$\frac{d(\cos x)}{dx} = -\sin x$$

$$\frac{d(\cos^{-1} x)}{dx} = \frac{1}{\sqrt{1-x^2}}$$

$$\frac{d(\tan x)}{dx} = \sec^2 x$$

$$\frac{d(\tan^{-1} x)}{dx} = \frac{1}{1+x^2}$$

Hyperbolic

$$\frac{d(\cosh x)}{dx} = \sinh x$$

$$\frac{d(\cosh^{-1} x)}{dx} = \frac{1}{\sqrt{x^2-1}}$$

$$\frac{d(\sinh x)}{dx} = \cosh x$$

$$\frac{d(\sinh^{-1} x)}{dx} = \frac{1}{\sqrt{x^2+1}}$$

$$\frac{d(\tanh x)}{dx} = \operatorname{sech}^2 x$$

$$\frac{d(\tanh^{-1} x)}{dx} = \frac{1}{1-x^2}$$

Transcendental

$$\frac{d(\ln x)}{dx} = \frac{1}{x}$$

$$\frac{d(e^x)}{dx} = e^x$$

$$\frac{d(a^x)}{dx} = a^x \ln a$$

$$\frac{d(u^v)}{dx} = vu^{v-1} \cdot \frac{du}{dx} + \ln u \cdot u^v \cdot \frac{dv}{dx}$$

Appendix E. Integrals

$$\int du = u + C$$

$$\int a du = au + C \quad \text{where } a \text{ is any constant}$$

$$\int [f(u) + g(u)] du = \int f(u) du + \int g(u) du$$

$$\int u^n du = \frac{u^{n+1}}{n+1} + C \quad n \neq -1$$

$$\int \frac{du}{u} = \ln |u| + C$$

$$\int a^u du = \frac{a^u}{\ln a} + C$$

$$\int e^u du = e^u + C$$

$$\int \sin u du = -\cos u + C$$

$$\int \cos u du = \sin u + C$$

$$\int \sec^2 u du = \tan u + C$$

$$\int \csc^2 u du = -\cot u + C$$

$$\int \sec u \tan u du = \sec u + C$$

$$\int \csc u \cot u du = -\csc u + C$$

$$\int \tan u du = \ln |\sec u| + C$$

$$\int \cot u du = \ln |\sin u| + C$$

$$\int \sec u du = \ln |\sec u + \tan u| + C$$

$$\int \csc u du = \ln |\csc u - \cot u| + C$$

$$\int \frac{du}{\sqrt{a^2 - u^2}} = \sin^{-1} \frac{u}{a} + C \quad \text{where } a > 0$$

$$\int \frac{du}{a^2 + u^2} = \frac{1}{a} \tan^{-1} \frac{u}{a} + C$$

$$\int \frac{du}{u\sqrt{u^2 - a^2}} = \frac{1}{a} \sec^{-1} \left| \frac{u}{a} \right| + C \quad \text{where } a > 0$$

$$\int \sinh u du = \cosh u + C$$

$$\int \cosh u du = \sinh u + C$$

$$\int \operatorname{sech}^2 u du = \tanh u + C$$

$$\int \operatorname{csch}^2 u du = -\operatorname{coth} u + C$$

$$\int \operatorname{sech} u \tanh u du = -\operatorname{sech} u + C$$

$$\int \operatorname{csch} u \operatorname{coth} u du = -\operatorname{csch} u + C$$

Integration by parts

$$\int u dv = uv - \int v du$$

Appendix F. Mathematical Formulae

Quadratic

$$x = \frac{-b \pm \sqrt{b^2 - 4ac}}{2a}$$

Binomial

$$(a + b)^n = \sum_{k=0}^n \binom{n}{k} a^{n-k} b^k$$

$$\text{where } \binom{n}{k} = \frac{n!}{k!(n-k)!}$$

Distance between (x_1, y_1, z_1) and (x_2, y_2, z_2)

$$d = \sqrt{(x_1 - x_2)^2 + (y_1 - y_2)^2 + (z_1 - z_2)^2}$$

Exponential and Logarithmic Identities

$$a^0 = 1 \quad (a^x)(a^y) = a^{x+y} \quad \ln ab = \ln a + \ln b$$

$$\frac{1}{a^x} = a^{-x} \quad a^x/a^y = a^{x-y} \quad \ln\left(\frac{a}{b}\right) = \ln a - \ln b$$

$$(ab)^x = a^x b^x \quad (a^x)^y = a^{xy} \quad \ln(y^x) = x \ln y$$

$$e = \lim_{n \rightarrow \infty} \left(1 + \frac{1}{n}\right)^n$$

Law of Cosines

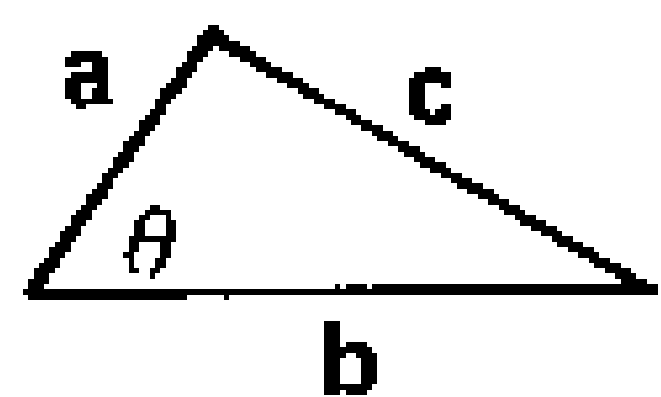

$$a^2 + b^2 - 2ab \cos \theta = c^2$$

Law of Sines

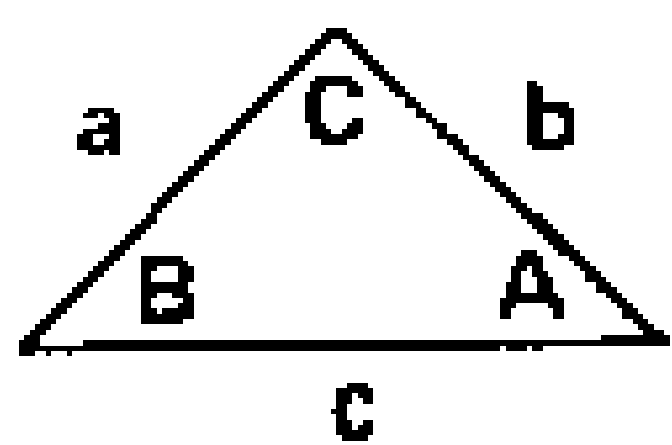

$$\frac{\sin A}{a} = \frac{\sin B}{b} = \frac{\sin C}{c}$$

Appendix G. Geometry Formulae

Circle

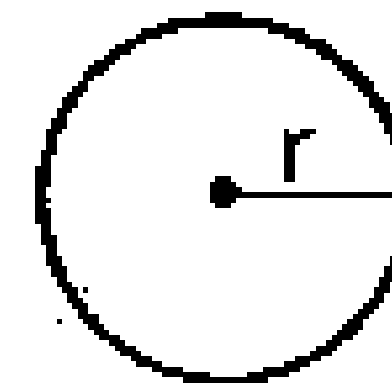

Sphere



Ellipse

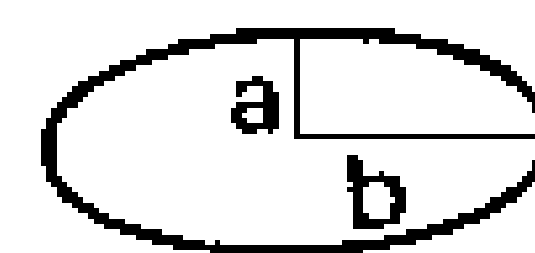

Triangle

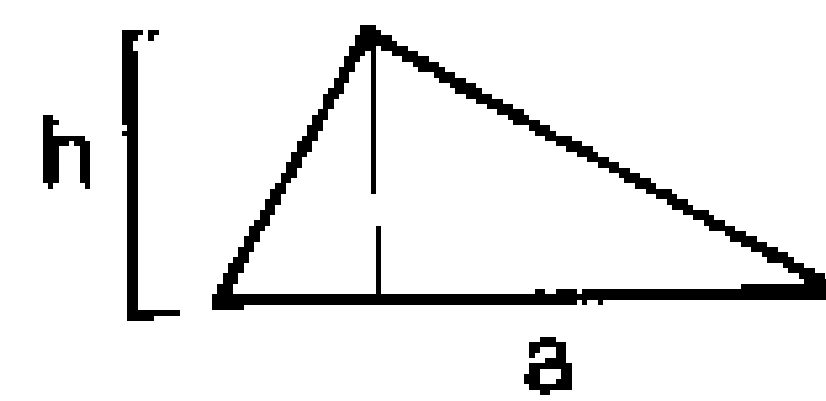

Cylinder

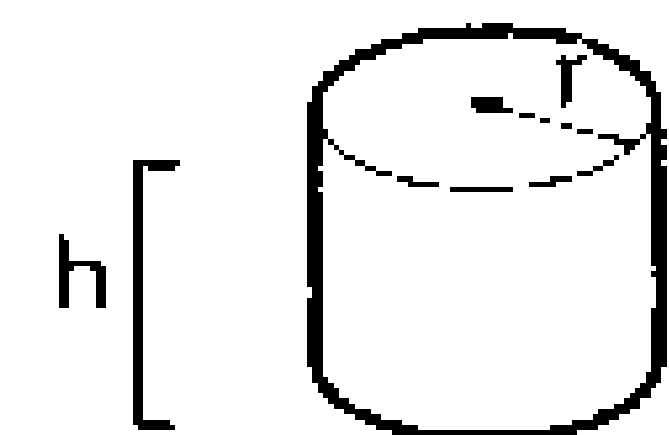

Cone

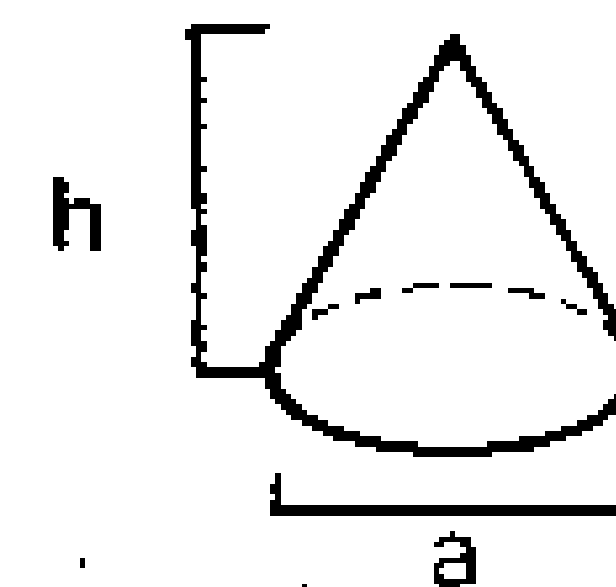

Circumference

Circle $2\pi r$

Area

Circle πr^2

Sphere $4\pi r^2$

Ellipse πab

Triangle $1/2 ab$

Volume

Sphere $4/3\pi r^3$

Cylinder $\pi r^2 h$

Cone $\frac{\pi a^2 h}{3}$

Equation

Circle $\frac{x^2}{r^2} + \frac{y^2}{r^2} = 1$

Ellipse $\frac{x^2}{a^2} + \frac{y^2}{b^2} = 1$

Hyperbola $\frac{x^2}{a^2} - \frac{y^2}{b^2} = 1$

Parabola $y^2 = \pm 2px$

Line $y = mx + b$

Appendix H. Conversions

English to Metric

To Find	Multiply	By
microns	mils	25.4
centimeters	inches	2.54
meters	feet	0.3048
meters	yards	0.9144
kilometers	miles	1.609344
grams	ounces	28.349523
kilograms	pounds	0.45359237
liters	gallons(U.S.)	3.7854118
liters	gallons(imp.)	4.546090
milliliters(cc)	fl. ounces	29.573530
sq. centimeters	sq. inches	6.4516
sq. meters	sq. feet	0.09290304
sq. meters	sq. yards	0.83612736
milliliters(cc)	cu. inches	16.387064
cu. meters	cu. feet	2.8316847 x 10 ⁻²
cu. meters	cu. yards	0.76455486

Temperature Conversions

$$F = \frac{9}{5}(C) + 32$$

$$C = \frac{5}{9}(F - 32)$$

General

To Find	Multiply	By
atmospheres	feet of water @ 4°C	.0294990
atmospheres	inches of mercury @ 0°C	.0334211
atmospheres	pounds per sq. inch	.068046
BTU	foot-pounds	.00128593
BTU	joules	9.4845 x 10 ⁻⁴
cu. ft.	cords	128
ergs	foot-pounds	13558200
feet	miles	5280
feet of water @ 4°C	atmosphere	33.8995
foot-pounds	horsepower-hours	1.98 x 10 ⁶
foot-pounds	kilowatt-hours	2655220
foot-pounds per min.	horsepower	3.3 x 10 ⁴
horsepower	foot-pounds per sec.	.00181818
inches of mercury @ 0°C	pounds per sq. inch	2.03602
joules	BTU	1054.3504
joules	foot-pounds	1.35582
kilowatts	BTU per min.	.01757251
kilowatts	foot-pounds per min.	2.2597 x 10 ⁻⁵
kilowatts	horsepower	.7457
knots	miles per hour	0.86897624
miles	feet	1.89393 x 10 ⁻⁴
nautical miles	miles	0.86897624
sq. feet	acres	43560
watts	BTU per min.	17.5725

Boldface numbers are exact; others are rounded.

Appendix I. Physical Constants

Name of Quantity	Symbol	Value
Speed of light in vacuum	c	$2.9979 \times 10^8 \text{ m s}^{-1}$
Charge of electron	q_e	$-1.602 \times 10^{-19} \text{ C}$
Rest mass of electron	m_e	$9.10 \times 10^{-31} \text{ kg}$
Ratio of charge to mass of electron	q_e/m_e	$1.759 \times 10^{11} \text{ C kg}^{-1}$
Planck's constant	h	$6.626 \times 10^{-34} \text{ J s}$
Boltzmann's constant	k	$1.381 \times 10^{-23} \text{ J K}^{-1}$
Avogadro's number (chemical scale)	N_0	$6.023 \times 10^{23} \text{ molecules mole}^{-1}$
Universal gas constant (chemical scale)	R	$8.314 \text{ J mole}^{-1} \text{ K}^{-1}$
Mechanical equivalent of heat	J	$4.185 \times 10^3 \text{ J kcal}^{-1}$
Standard atmospheric pressure	1 atm	$1.013 \times 10^5 \text{ N m}^{-2}$
Volume of ideal gas at 0° C and 1 atm (chemical scale)		$22.415 \text{ liters mole}^{-1}$
Absolute zero of temperature	0 K	-273.15° C
Acceleration due to gravity (sea level, at equator)		9.78049 m s^{-2}
Universal gravitational constant	G	$6.673 \times 10^{-11} \text{ N} \cdot \text{m}^2 \text{ kg}^{-2}$
Mass of earth	m_E	$5.975 \times 10^{24} \text{ kg}$
Mean radius of earth		$6.371 \times 10^6 \text{ m} = 3959 \text{ mi}$
Equatorial radius of earth		$6.378 \times 10^6 \text{ m} = 3963 \text{ mi}$
Mean distance from earth to sun	1 AU	$1.49 \times 10^{11} \text{ m} = 9.29 \times 10^7 \text{ mi}$
Eccentricity of earth's orbit		0.0167
Mean distance from earth to moon		$3.84 \times 10^8 \text{ m} = 60 \text{ earth radii}$
Diameter of sun		$1.39 \times 10^9 \text{ m} = 8.64 \times 10^5 \text{ mi}$
Mass of sun	m_s	$1.99 \times 10^{30} \text{ kg} = 333,000 \times \text{mass of earth}$
Coulomb's law constant	$k = 1/4 \pi \epsilon_0$	$8.9874 \times 10^9 \text{ N} \cdot \text{m}^2 \text{ C}^{-2}$
Faraday's constant (1 faraday)	F	$96.487 \text{ C mole}^{-1}$
Mass of neutral hydrogen atom	m_H^1	1.007825 amu
Mass of proton	m_p	1.007277 amu
Mass of neutron	m_n	1.008665 amu
Mass of electron	m_e	$5.486 \times 10^{-4} \text{ amu}$
Ratio of mass of proton to mass of electron	m_p/m_e	1836.11
Rydberg constant for nucleus of infinite mass	R_∞	109.737 cm^{-1}
Rydberg constant for hydrogen	R_H	109.678 cm^{-1}
Wien displacement law constant		0.2898 cm K^{-1}

Appendix J. Table of Units

Supplementary Tables Units for a System of Measures for International Relations		
Length	meter	m
Mass	kilogram	kg
Time	second	s
Electric current	ampere	A
Temperature	Kelvin	K
Luminous intensity	candela	cd

Prefix Names of Multiples and Submultiples of Units		
Factor by which unit is multiplied	Prefix	Symbol
10^{12}	tera	T
10^9	giga	G
10^6	mega	M
10^3	kilo	k
10^2	hecto	h
10	deka	da
10^{-1}	deci	d
10^{-2}	centi	c
10^{-3}	milli	m
10^{-6}	micro	μ
10^{-9}	nano	n
10^{-12}	pico	p
10^{-15}	femto	f
10^{-18}	atto	a

Acceleration
Activity (of radioactive source)
Angular acceleration
Angular velocity
Area
Density
Dynamic viscosity
Electric capacitance
Electric charge
Electric field strength
Electric resistance
Entropy
Force
Frequency
Illumination
Inductance
Kinematic viscosity
Luminance
Luminous flux
Magnetomotive force
Magnetic field strength
Magnetic flux
Magnetic flux density
Power
Pressure
Radiant Intensity
Specific heat
Thermal conductivity
Velocity
Volume
Voltage, Potential difference, Electromotive force
Wave number
Work, energy, quantity of heat

		Derived Units
m/s^2		meter per second squared
s^{-1}		1 per second
rad/s^2		radian per second squared
rad/s		radian per second
m^2		square meter
kg/m^3		kilogram per cubic meter
$N \cdot s/m^2$		newton-second per sq meter
F	(A·s/V)	farad
C	(A·s)	coulomb
V/m		volt per meter
	(V/A)	ohm
J/K		joule per kelvin
N	(kg·m/s ²)	newton
Hz	(s ⁻¹)	hertz
lx	(lm/m ²)	lux
H	(V·s/A)	henry
m^2/s		sq meter per second
cd/m^2		candela per sq meter
lm	(cd·sr)	lumen
A		ampere
A/m		ampere per meter
Wb	(V·s)	weber
T	(Wb/m ²)	tesla
W	(J/s)	watt
N/m^2		newton per square meter
W/sr		watt per steradian
J/kg K		joule per kilogram kelvin
W/m K		watt per meter kelvin
m/s		meter per second
m^3		cubic meter
V	(W/A)	volt
m^{-1}		1 per meter
J	(N·m)	joule

Appendix K.

Batteries and Maintenance

AC Operation

If you have bought or own a Commodore adapter, connect this optional adapter to any standard electrical outlet and plug the jack into the calculator. After the above connections have been made, the power switch may be turned "ON." (While connected to AC, the battery may be left in place or removed.)

Use proper Commodore/CBM adapter for AC operation. Adapter 640 or 707 North America; Adapter 708 England; Adapter 709 West Germany.

Battery Operation

Push the power switch "ON." An interlock switch in the calculator socket will prevent battery operation if the adapter jack remains connected.

Your new calculator uses one ordinary 9 volt rectangular battery, available virtually anywhere. The connector must be attached firmly to the two battery terminals.

Low Power

If battery is low, calculator display:

- a. will appear erratic
- b. will dim
- c. will fail to accept numbers

If one or all of the above conditions occur, you may check for a low battery condition by entering a series of 8's. If 8's fail to appear, operations should not be continued on battery power. Unit may be operated on AC power.

CAUTION

A strong static discharge will damage your machine.

Shipping Instructions

A defective machine should be returned to the authorized service center nearest you. See listing of service centers.

TEMPERATURE RANGE

Mode	Temperature °C	Temperature °F
Operating	0° to 50°	32° to 122°
Storage	-40° to 55°	-40° to 131°