

UC-NRLF



B 4 249 268

Vol. 32.

TREATISE
on
MATHEMATICAL INSTRUMENTS.

by
BY J. P. HEATHER, M.A.,
OF THE ROYAL ACADEMY, WINDMICH.

With Illustrations.

Price 1s.

LONDON — JOHN WEALE.

IN MEMORIAM

George Davidson

1825-1911

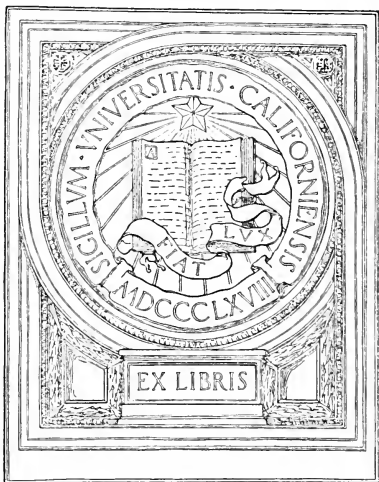

Professor of Geography
University of California

[Faint, illegible handwriting]

To
Prof. George Davidson
Assist. Coast & Geodetic Survey
San Francisco
Cal.

no 10
/ 81.

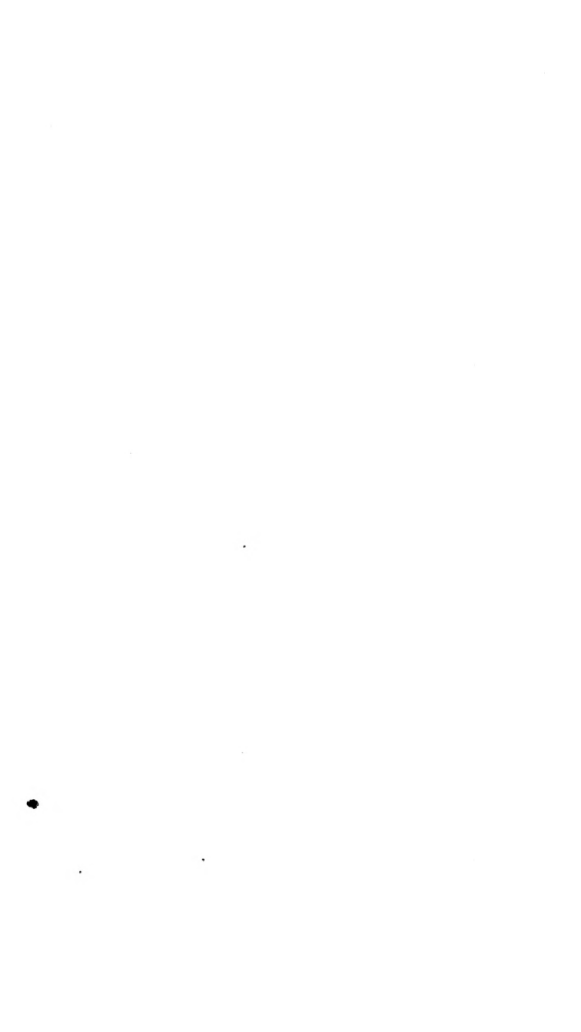

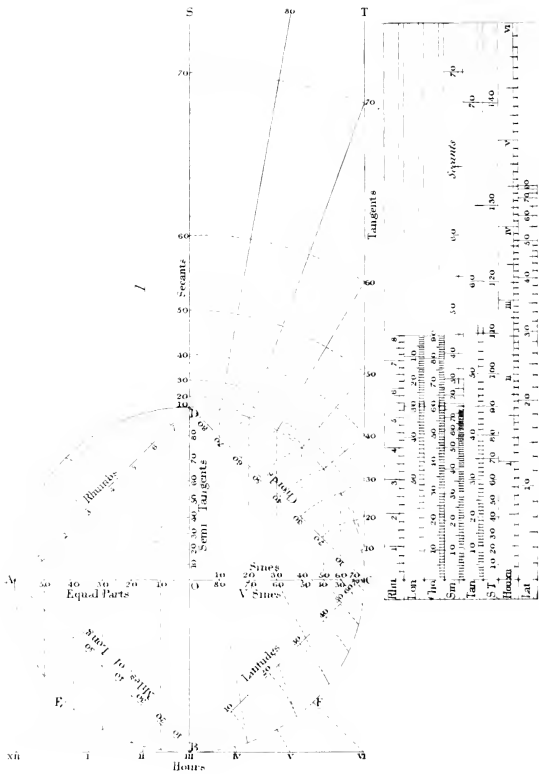

A ✓

TREATISE

ON

MATHEMATICAL INSTRUMENTS,

INCLUDING

MOST OF THE INSTRUMENTS EMPLOYED IN DRAWING,
FOR ASSISTING THE VISION, IN SURVEYING AND LEVELLING, IN PRACTICAL
ASTRONOMY, AND FOR MEASURING THE ANGLES OF CRYSTALS:

IN WHICH

THEIR CONSTRUCTION, AND THE METHODS OF
TESTING, ADJUSTING, AND USING THEM,

ARE CONCISELY EXPLAINED.

BY J. F. HEATHER, M.A.

OF THE ROYAL MILITARY ACADEMY, WOOLWICH.

THIRD EDITION,
WITH CORRECTIONS.

LONDON:
JOHN WEALE, 59, HIGH HOLBORN.

1856.

LONDON:
BRADBURY AND EVANS, PRINTERS, WHITEFRIARS.

PREFACE.

AN attempt has been made in the following pages to put within the reach of all a short and compendious treatise upon some of the ingenious instruments by which the scientific practitioner is aided in his observations, and in the delineation of the results obtained from them.

The instruments treated of have been divided into five classes, to each of which a part of the work has been devoted. The first part treats of Mathematical Drawing Instruments; the second, of Optical Instruments; the third, of Surveying Instruments; the fourth, of Astronomical Instruments; and the fifth, and last, of Goniometrical Instruments, for measuring the angles of crystals.

The greater part of the Wood Engravings, and some parts of the Text, of Simms's Mathematical Drawing Instruments, have been pressed into the service of the present work; and the works of the best writers upon the several parts of the subject have been consulted, and much valuable matter has been extracted from them, particularly from Pearson's Astronomy.

The limits of the bulk and cost of the work have forbidden any extensive excursion into the sciences in which the instruments are used; but it is hoped that a large mass of information has here been placed in a small compass without sacrificing perspicuity to undue compression

R. M. A.
March, 1849.

CONTENTS.

PART I.

ON MATHEMATICAL DRAWING INSTRUMENTS.

	Page
Compasses.—Hair Compasses.—Compasses with Movable Points.	
—Bow Compasses	1
Wholes and Halves	4
Proportional Compasses	4
Triangular Compasses	6
Drawing Pen	7
Road Pen	8
Pricking Point	8
Straight Edge	8
Scales of Equal Parts	9
Protracting Scales	14
Gunter's Lines	25
The Plain Scale	33
Sector	33
Marquois's Scales	42
Vernier	45
Micrometer	47
Beam Compasses	48
Plotting Scales	50
Pantagraph	50
Coggeshall's Sliding Rule	55
Management of Drawing Paper, &c.	64
General Rules in Geometrical Construction	66

PART II.

ON OPTICAL INSTRUMENTS.

Prism	67
Lenses	70
Reflectors, Plane	74
— Curvilinear	75
Microscopes	76
Telescopes, Refracting	81
— Reflecting	84
— Adjusted and Tested	86
Solar Microscope	88
Camera Obscura	89
— Lucida	90

PART III.

SURVEYING INSTRUMENTS.

	Page
Land Chain	92
Off-setting Staff	95
Spirit Level	96
Y Level	97
Levelling Staff	104
Troughton's Level	104
Gravatt's	105
Levelling, Remarks on	106
Water Level	112
Reflecting Level	113
Prismatic Compass	115
Box Sextant	117
Artificial Horizon	121
Theodolite	122
Surveying, Remarks on	126
Circular Protractor	129
T Square and Semicircular Protractor	131
Plotting Scale of best Form	133
Computation of the Area of a Plot	135
Station Pointer	135

PART IV.

ASTRONOMICAL INSTRUMENTS.

Hadley's Sextant	137
Troughton's Reflecting Circle	141
The Dip Sector	144
The Transit Instrument	144
Method of Observing with the Transit	151
The Altitude and Azimuth Instrument	153
The Reading Microscope	160
The Collimator	162

PART V.

ON GONIOMETERS.

The Common Goniometer	164
Wollaston's Goniometer	165

A TREATISE

ON

MATHEMATICAL INSTRUMENTS.

PART I.—ON MATHEMATICAL DRAWING INSTRUMENTS.

IN this branch of the subject the limits of our little work will not permit us to enter upon all the beautiful contrivances which have been invented for facilitating the operations of the draughtsman; but we shall endeavour to describe the constructions and applications of such as are in most general use, and, as far as our space will allow, to exhibit the principles upon which they are founded, so that the student may readily extend his views, after having completely mastered the matter here presented to him, to the principles of any other instruments, which may be useful to him in whatever particular professional branch of practical mathematics he may wish to employ himself. With this view we shall describe the instruments in the ordinary case of drawing instruments, as sold by any mathematical instrument maker; viz.,

Compasses with moveable point, ink point, and pencil point.	Drawing pen and pricking point.
Hair compasses.	Plain scale.
Bow compasses.	Sector.

And we shall also give some account of the following; viz.,

Whole and halves.	Beam compasses.
Proportional compasses.	Plotting scales.
Triangular compasses.	The pantagraph.
Marquois's scales.	Sliding Rule.

ON DRAWING COMPASSES.

This instrument consists of two legs moveable about a joint, so that the points at the extremities of the legs may be set at any required distance from one another; it is used to transfer and measure distances, and to describe arcs and circles.

The points of the compasses should be formed of well-tempered steel, that cannot be easily bent or blunted, the upper part being formed of brass or silver. The joint is framed of two substances; one side being of the same material as

the upper part of the compasses, either brass or silver, and the other of steel. This arrangement diminishes the wear of the parts, and promotes uniformity in their motion. If this uniformity be wanting, it is extremely difficult to set the compasses at any desired distance, for, being opened or closed by the pressure of the finger, if the joint be not good, they will move by fits and starts, and either stop short of, or go beyond the distance required; but, when they move evenly, the pressure may be regulated so as to open the legs to the desired extent, and the joint should be stiff enough to hold them in this position, and not to permit them to deviate from it in consequence of the small amount of pressure which is inseparable from their use. When greater accuracy in the set of the compasses is required than can be effected by the joint alone, we have recourse to the

Hair Compasses, in which the upper part of one of the steel points is formed into a bent spring, which, being fastened at one extremity to the leg of the compasses almost close up to the joint, is held at the other end by a screw. A groove is formed in the shank, which receives the spring when screwed up tight; and, by turning the screw backwards, the steel point may be gradually allowed to be pulled backwards by the spring, and may again be gradually pulled forwards by the screw being turned forwards.

Fig. 1 represents these compasses when shut; fig. 2 represents them open, with the screw turned backwards,

Fig. 1



Fig.



Fig. 3



and the steel point *p*, in consequence moved backwards by its spring *s*, from the position represented by the dotted lines, which it would have when screwed tight up.

Fig. 3 represents a key, of which the two points fit into the two holes seen in the nut, *n*, of the joint; and by turning this nut the joint is made stiffer or easier at pleasure.

To take a Distance with the Hair Compasses.—Open them as nearly as you can to the required distance, set the fixed leg on the point from which the distance is to be taken, and make the extremity of the other leg coincide accurately with the end of the required distance, by turning the screw.

COMPASSES WITH MOVEABLE POINTS.

If an arc or circle is to be described faintly, merely as a guide for the terminating points of other lines, the steel points are generally sufficient for the purpose, and are susceptible of adjustment with greater accuracy than a pencil point; but, in order to draw arcs or circles with ink or black lead, compasses with a moveable point are used. In the best description of these compasses the end of the shank is formed into a strong spring, which holds firmly the moveable point, or a pencil or ink point, as may be required. A lengthening bar may also be attached between the shank and the moveable point, so as to strike larger circles, and measure greater distances. The moveable point to be attached to the lengthening bar, as also the pen point and pencil point, are furnished with a joint, that they may be set nearly perpendicular to the paper.

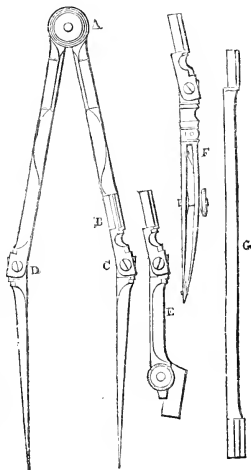

A, the compasses, with a moveable point at B.

C and D, the joints to set each point perpendicular to the paper.

E, the pencil point.

F, the pen point. (This is represented with a dotting wheel, the pen point and the dotting point being similar in shape to each other.)

G, the lengthening bar.

To describe small arcs or circles a small pair of compasses, called *bow compasses*, with a permanent ink or pencil point, are used. They are formed with a round head, which rolls with ease between the fingers. The adjoining figures represent two constructions of pen bows, fig. 1 being well adapted to describe arcs of not more than one inch radius, and fig. 2 to describe arcs of small radii with exactness by means of the adjusting screw *c*.

For copying and reducing drawings, compasses of a peculiar construction are used; the simplest form of which is that called *wholes and halves*, because the longer legs being twice the length of the shorter, when the former are opened to any given line, the shorter ones will be opened to the half of that line. By their means, then, all the lines of a drawing may be reduced to one-half, or enlarged to double their length. These compasses are also useful for dividing lines by continual bisections.

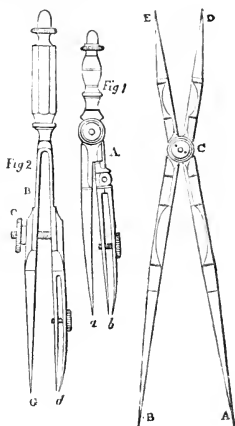

PROPORTIONAL COMPASSES.

By means of this ingenious instrument drawings may be reduced or enlarged, so that all the lines of the copy, or the areas or solids represented by its several parts, shall bear any required proportion to the lines, areas, or solids of the original drawing. They will also serve to inscribe regular polygons in circles, and to take the square roots and cube roots of numbers. In the annexed figure the scale of lines is placed on the leg *A E*, on the left-hand side of the groove, and the scale of circles, on the same leg, on the right-hand side of the groove. The scales of plans and solids are on the other face of the instrument.

To set the instrument it must first be accurately closed, so

that the two legs appear but as one; the nut *c* being then unscrewed, the slider may be moved, until the line across it coincides with any required division upon any one of the scales. Now tighten the screw, and the compasses are set.

To reduce or enlarge the Lines of a Drawing.—The line across the slider being set to one of the divisions, 2, 3, 4, &c., on the scale of lines, the points *A*, *B* will open to double, triple, four times, &c., the distances of the points *D*, *E* (Euc. vi. prop. 4). If, then, the points *A* and *B* be opened to the lengths of the lines upon a drawing, the points *D* and *E* will prick off a copy with the lines reduced in the proportions of $\frac{1}{2}$ to 1, $\frac{1}{3}$ to 1, $\frac{1}{4}$ to 1, &c.; but, if the points *D* and *E* be opened to the lengths of the lines upon a drawing, the points *A* and *B* will prick off a copy with the lines enlarged in the proportions of 2 to 1, 3 to 1, 4 to 1, &c.

To inscribe in a Circle a regular Polygon of any number of Sides from 6 to 20.—The line across the slider being set to any number on the scale of circles, and the points *A* and *B* being opened to the length of any radius, the points *D* and *E* will prick off a polygon of that number of sides, in the circle described with this radius; thus, if the line across the slider be set to the division marked 12 on the scale of circles, and a circle be described with the radius *A B*, *D E* will be the chord of a $\frac{1}{12}$ th part of the circumference, and will prick off a regular polygon of 12 sides in it.

To reduce or enlarge the Area of a Drawing.—The numbers upon the scale of plans are the squares of the ratios of the lengths of the opposite ends of the compasses, when the line across the slider is set to those numbers; and, the distances between the points being in the same ratio as the lengths of the corresponding ends (Euc. vi. prop. 4), the areas of the drawings, and of the several parts of the drawings, pricked off by these points, will have to one another the ratio of 1 to the number upon the scale of plans to which the instrument is set (Euc. vi. props. 19, 20; and xii. prop. 2). Thus, if the line across the slider be set to 4 on the scale of plans, the distance between the points *A* and *B* will be twice as great as the distance between *D* and *E*; and, if *A* and *B* be opened out to the lengths of the several lines of a drawing, *D* and *E* will prick off a copy occupying $\frac{1}{4}$ th the area; if the line across the

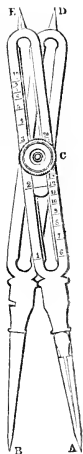

slides be set to 5 on the same scale, the distances between the points will be in the ratio of 1 to $\sqrt{5}$, and the area of the copy pricked off by the points D and E will be $\frac{1}{5}$ th of the area of the drawing, of which the lines are taken off by A and B. conversely, if the lines of the drawing be taken off by the points D and E, the points A and B will prick off a copy, of which the area will be 4 times or 5 times as great, according as the line across the slider is set to the division marked 4 or 5 on the scale.

To take the Square Root of a Number.—The line across the slider being set to the number upon the scale of plans, open the points A and B to take the number from any scale of equal parts (see page 9), then the points D and E applied to the same scale of equal parts will take the square root of the number. Thus, to take the square root of 3, set the line across the slider to 3, open out the compasses, till A and B take off 3 from any scale of equal parts, and the points D and E will take off 1.73, which is the square root of 3 from the same scale of equal parts. A mean proportional between two numbers, being the square root of their product, may be found by multiplying the numbers together, and then taking the square root of the product in the manner explained above.

The numbers of the scale of solids are the cubes of the ratios of the lengths of the opposite ends of the compasses, when the line across the slider is set to those numbers; so that, when this line is set to the division marked 2 upon the scale of solids, the distance between the points A and B will give the side of a solid of double the content of that, of which a like side is given by the distance of the points D and E when the line is set to 3, the respective distances of the points will give the like sides of solids, the contents of which will be in the proportion of 3 to 1; and so on.

The Cube Root of a given number may be found by setting the line across the slider to the number upon the scale of solids, and, opening the points A, B, to take off the number upon any scale of equal parts, the points D, E, will then take off the required cube root from the same scale.

THE TRIANGULAR COMPASSES.

One of the best forms of these instruments is represented in the annexed figure. *abc* is a solid tripod, having at the extremity of the three arms three limbs, *d*, *e*, and *f*, moving freely upon centers by which they may be placed in any po-

sition with respect to the tripod and each other. These limbs carry points at right angles to the plane of the instrument, which may be brought to coincide, in the first instance, with any three points on the original, and then transferred to the copy. After this first step two of these points must be set upon two points of the drawing already copied, and the third made to coincide with a new point of the drawing, that is, one not yet copied: then, by placing the two first points on the corresponding points in the copy, the third point of the compasses will transfer the new point to the copy.

Another form of triangular compasses is represented in the annexed figure.

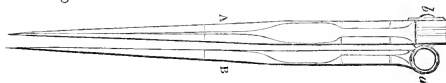
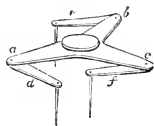

THE DRAWING-PEN.

This instrument is used for drawing straight lines. It consists of two blades with steel points fixed to a handle; and they are so bent, that a sufficient cavity is left between them for the ink, when the ends of the steel points meet close together, or nearly so. The blades are set with the points more or less open by means of a mill-headed screw, so as to draw lines of any required fineness or thickness. One of the blades is framed with a joint, so that by taking out the screw the blades may be completely opened, and the points effectively cleaned after use. The ink is to be put between the blades by a common pen, and in using the pen it should be slightly inclined in the direction of the line to be drawn, and care should be taken that both points touch the paper; and the observations

Fig. 1.

Fig. 2.

Fig. 3.

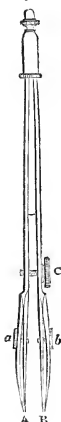

equally apply to the pen points of the compasses before described. The drawing-pen should be kept close to the straight edge (see STRAIGHT EDGE), and in the same direction during the whole operation of drawing the line.

For drawing close parallel lines in mechanical and architectural drawings, or to represent canals or roads, a double pen (fig. 2) is frequently used, with an adjusting screw to set the pen to any required small distance. This is usually called the road pen. The best pricking point is a fine needle held in a pair of forceps (fig. 3). It is used to mark the intersections of lines, or to set off divisions from the plotting scale and protractor (p. 33). This point may also be used to prick through a drawing upon an intended copy, or, the needle being reversed, the eye end forms a good tracing point.

A STRAIGHT EDGE.

As many instruments are required to have straight edges for the purpose of measuring distances, and of drawing straight lines, it may be considered important to test the accuracy of such edges. This may be done by placing two such edges in contact and sliding them along each other, while held up between the eye and the light: if the edges fit close in some parts, so as to exclude the light, but admit it to pass between them at other parts, the edges are not true: if, however, the edges appear, as far as the test has now proceeded, to be true, still this may arise from a curvature in one edge fitting into an opposite curvature in the other; the final step then is to take a third edge, and try it in the same manner with each of the other two, and if in each case the contact be close throughout the whole extent of the edges, then they are all three good*.

“To draw a straight line between two points upon a plane, we lay a rule so that the straight edge thereof may just pass by the two points; then moving a fine-pointed needle, or drawing-pen, along this edge, we draw a line from one point to the other, which, for common purposes, is sufficiently exact; but, where great accuracy is required, it will be found extremely difficult to lay the rule equally with respect to both the points, so as not to be nearer to one point than the other. It is difficult also so to carry the needle, or pen, that it shall neither incline more to one side than the other of the rule; and, thirdly, it is very difficult to find a rule that shall be perfectly straight.

“If the two points be very far distant, it is almost impossible to draw the line with accuracy and exactness; a circular line may be described more easily, and more exactly, than a straight or any other line, though even then many difficulties occur, when the circle is required to be of a large radius.

“And let no one consider these reflections as the effect of too scrupulous exactness, or as an unnecessary aim at precision; for, as the foundation of

* Euc. bk. i. def. 10. Peacock's Algebra, 1st edition, art. 532. p. 429.

all our knowledge in geography, navigation, and astronomy, is built on observations, and all observations are made with instruments, it follows that the truth of the observations, and the accuracy of the deductions therefrom, will principally depend on the exactness with which the instruments are made and divided, and that those sciences will advance in proportion as these are less difficult in their use, and more perfect in the performance of their respective operations."*

ON SCALES.

Scales of equal parts are used for measuring straight lines, and laying down distances, each part answering for one foot, one yard, one chain, &c., as may be convenient, and the plan will be larger or smaller as the scale contains a smaller or a greater number of parts in an inch.

Scales of equal parts may be divided into three kinds; simply-divided scales, diagonal scales, and vernier scales.

Simply-divided Scales.—Simply-divided scales consist of any extent of equal divisions, which are numbered 1, 2, 3, &c., beginning from the second division on the left hand. The first of these primary divisions is subdivided into ten equal parts, and from these last divisions the scale is named. Thus it is called a scale of 30, when 30 of these small parts are equal to one inch. If, then, these subdivisions be taken as units, each to represent one mile, for instance, or one chain, or one foot, &c., the primary divisions will be so many tens of miles, or of chains, or of feet, &c.; if the subdivisions are taken as tens, the primary divisions will be hundreds; and, if the primary divisions be units, the subdivisions will be tenths.

The accompanying drawing represents six of the simply-divided scales, which are generally placed upon the plain scale. To adapt them to feet and inches, the first primary division is divided duodecimally upon an upper line. To lay down 360, or 36, or 3·6, &c., from any one of these scales, extend the compasses from the primary division numbered 3 to the 6th lower sub-



* Geometrical and Geographical Essays, by the late George Adams, edited by William Jones, F.Am.P.S.

division, reckoning backwards, or towards the left hand. To take off any number of feet and inches, 6 feet 7 inches for instance, extend the compasses from the primary division numbered 6, to the 7th upper subdivision, reckoning backwards, as before.

Diagonal Scales.—In the simply-divided scales one of the primary divisions is subdivided only into ten equal parts, and the parts of any distance which are less than tenths of a primary division cannot be accurately taken off from them; but, by means of a diagonal scale, the parts of any distance which are the hundredths of the primary divisions are correctly indicated, as will easily be understood from its construction, which we proceed to describe.

Draw eleven parallel equidistant lines; divide the upper of these lines into equal parts of the intended length of the primary divisions; and through each of these divisions draw perpendicular lines, cutting all the eleven parallels, and number these primary divisions, 1, 2, 3, &c., beginning from the second.

Subdivide the first of these primary divisions into ten equal parts, both upon the highest and lowest of the eleven parallel lines, and let these subdivisions be reckoned in the opposite direction to the primary divisions, as in the simply-divided scales.

Draw the diagonal lines from the tenth subdivision below to the ninth above; from the ninth below to the eighth above; and so on; till we come to a line from the first below to the zero point above. Then, since these diagonal lines are all parallel, and consequently everywhere equidistant, the distance between any two of them in succession, measured upon any of the eleven parallel lines which they intersect, is the same as this distance measured upon the highest or lowest of these lines, that is, as one of the subdivisions before mentioned: but the distance between the perpendicular, which passes through the zero point, and the diagonal through the same point, being nothing on the highest line, and equal to



one of the subdivisions on the lowest line, is equal (Euc. vi. prop. 4) to one-tenth of a subdivision on the second line, to two-tenths of a subdivision on the third, and so on; so that this, and consequently each of the other diagonal lines, as it reaches each successive parallel, separates further from the perpendicular through the zero point by one-tenth of the extent of a subdivision, or one-hundredth of the extent of a primary division. Our figure represents the two diagonal scales which are usually placed upon the plane scale of six inches in length. In one, the distances between the primary divisions are each half an inch, and in the other a quarter of an inch. The parallel next to the figures numbering these divisions must be considered the highest or first parallel in each of these scales to accord with the above description.

The primary divisions being taken for units, to set off the numbers 5·74 by the diagonal scale. Set one foot of the compasses on the point where the fifth parallel cuts the eighth diagonal line, and extend the other foot to the point where the same parallel cuts the sixth vertical line.

The primary divisions being reckoned as tens, to take off the number 46·7. Extend the compasses from the point where the eighth parallel cuts the seventh diagonal to the point where it cuts the fifth vertical.

The primary divisions being reckoned as hundreds, to take off the number 253. Extend the compasses from the point where the fourth parallel cuts the sixth diagonal to the point where it cuts the third vertical.

Now, since the first of the parallels, of the diagonals, and of the verticals indicate the zero points for the third, second, and first figures respectively, the second of each of them stands for, and is marked, 1, the third, 2, and so on, and we have the following

General Rule.—To take off any number to three places of figures upon a diagonal scale. On the parallel indicated by the third figure, measure from the diagonal indicated by the second figure to the vertical indicated by the first.

Vernier Scales.—The nature of these scales will be understood from their construction. To construct a vernier scale, which shall enable us to take off a number to three places of figures: divide all the primary divisions into tenths, and number these subdivisions, 1, 2, 3, &c., from the left hand towards the right throughout the whole extent of the scale.

Take off now, with the compasses, eleven of these subdivisions, set the extent off backwards from the end of the first

primary division, and it will reach beyond the beginning of this division, or zero point, a distance equal to one of the subdivisions. Now divide the extent thus set off into ten equal parts, marking the divisions on the opposite side of the divided line to the strokes marking the primary divisions and the subdivisions, and number them 1, 2, 3, &c. backwards from right to left. Then, since the extent of eleven subdivisions has been divided into ten equal parts, so that these ten parts exceed by one subdivision the extent of ten subdivisions, each one of these equal parts, or, as it may be called, one division of the vernier scale, exceeds one of the subdivisions by a tenth part of a subdivision, or a hundredth part of a primary division. In our figure the distances between the primary divisions are each one inch, and, consequently, the distances between the subdivisions are each one-tenth of an inch, and the distances between the divisions of the vernier scale each one-tenth and one-hundredth of an inch.

To take off the number 253 from this scale. Increase the first figure 2 by 1, making it 3; because the vernier scale commences at the end of the first primary division, and the primary divisions are measured from this point, and not from the zero point*. The first thus increased with the second now represents 35 of the subdivisions from the zero point, from which the third figure, 3, must be subtracted, leaving 32; since three divisions of the vernier scale will contain three of these subdivisions, together with three-tenths of a subdivision. Place, then, one point of the compasses upon the third division of the vernier scale, and extend the other point to the 32nd subdivision, or the second division beyond the 3rd primary division, and laying down the distance between the points of the compass, it will represent 253, or 25·3, or 2·53, according as the primary divisions are taken as hundreds, tens, or units.

General Rule.—To take off any number to three places of figures upon this vernier scale. Increase the first figure by one; subtract the third figure from the second, borrowing one from the first increased figure, if ne-

* If the vernier scale were placed to the left of the zero point, a distance less than one primary division could not always be found upon the scale.



cessary, and extend the compasses from the division upon the vernier scale, indicated by the third figure, to the subdivision indicated by the number remaining after performing the above subtraction.

Suppose it were required to take off the number 253·5. By extending the compasses from the third division of the vernier scale to the 32nd subdivision, the number 253 is taken off, as we have seen. To take off, therefore, 253·5, the compasses must be extended from one of these points to a short distance beyond the other. Again, by extending the compasses from the 4th division of the vernier scale to the 31st subdivision, the number 254 would be taken off. To take off 253·5, then, the compasses must be extended from one of these points to within a short distance of the other; and by setting the compasses so that, when one point of the compasses is set successively on the 3rd and 4th division of the vernier scale, the other point reaches as far beyond the 32nd subdivision as it falls short of the 31st, the number 253·5 is taken off. If the excess in one case be twice as great as the defect in the other, the distance represents the number $253\frac{2}{3}$, or 253·66; and if the excess be half the defect, the distance represents $253\frac{1}{3}$, or 253·33. Thus distances may be set off with an accurately-constructed scale of this kind to within the three-hundredth part of a primary division, unless these divisions be themselves very small.

We are not aware that a scale of this kind has been put upon the plain scales sold by any of the instrument makers; but, during the time occupied in plotting an extensive survey, the paper which receives the work is affected by the changes which take place in the hygrometrical state of the air, and the parts laid down from the same scale, at different times, will not exactly correspond, unless this scale has been first laid down upon the paper itself, and all the divisions have been taken from the scale so laid down, which is always in the same state of expansion as the plot. For plotting, then, an extensive survey, and accurately filling in the minutiae, a diagonal, or vernier scale may advantageously be laid down upon the paper upon which the plot is to be made. A vernier scale is preferable to a diagonal scale, because in the latter it is extremely difficult to draw the diagonals with accuracy, and we have no check upon its errors; while in the former the uniform manner in which the strokes of one scale separate from those of the other is some evidence of the truth of both*.

* In Mr. Bird's celebrated scale, by means of which he succeeded in di-

ON THE PROTRACTING SCALES.

The nature of these scales will be understood from the following construction (plate 1, fig. 1):

With centre o , and radius $o A$, describe the circle $A B C D$; and through the centre o draw the diameters $A C$, and $B D$, at right angles to each other, which will divide the circle into four quadrants, $A B$, $B C$, $C D$, and $D A$.

Divide the quadrant $C D$ into nine equal parts, each of which will contain ten degrees, and these parts may again be subdivided into degrees, and, if the circle be sufficiently large, into minutes.

Set one foot of the compasses upon c , and transfer the divisions in the quadrant $C D$ to the right line $c D$, and we shall have a scale of chords*.

From the divisions in the quadrant $C D$, draw right lines parallel to $D o$, to cut the radius $o c$, and, numbering the divisions from o , towards c , we shall have a scale of sines.

If the same divisions be numbered from c , and continued to A , we shall have a scale of versed sines.

From the centre o , draw right lines through the divisions of the quadrant $C D$, to meet the line $c T$, touching the circle at c , and, numbering from c , towards T , we shall have a scale of tangents.

Set one foot of the compasses upon the center o , and transfer the divisions in $c T$ into the right line $o s$, and we shall have a scale of secants.

Right lines, drawn from A to the several divisions in the quadrant $C D$, will divide the radius $o D$ into a line of semi-tangents, or tangents of half the angles indicated by the numbers; and the scale may be continued by continuing the divisions from the quadrant $C D$, through the quadrant $D A$,

viding, with greatly-improved accuracy, the circles of astronomical instruments, the inches are divided into tenths, as in the scale described in the text, and 100 of these tenths are divided into 100 parts for the vernier scale.

* We give the constructions in the text to show the nature of the scales; but in practice a scale of chords is most accurately constructed by values computed from tabulated arithmetical values of sines, which computed values are set off from a scale of equal parts; and the circle is divided most accurately by means of such computed chords. The limits of our work forbid our entering further upon this interesting subject. All the other scales will also be most accurately constructed from computed arithmetical values, taken off by means of the beam compasses hereafter described, and corrected by the aid of a good Bird's vernier scale.

and drawing right lines from A, through these divisions, to meet the radius oD , produced.

Divide the quadrant AD into eight equal parts, subdivide each of these into four equal parts, and, setting one foot of the compasses upon A, transfer these divisions to the right line AD , and we shall have a scale of rhumbs.

Divide the radius AO into 60 equal parts, and number them from o towards A; through these divisions draw right lines parallel to the radius oB , to meet the quadrant AB ; and, with one foot of the compasses upon A, transfer these divisions from the quadrant to the right line AB , and we shall have a scale of longitudes.

Place the chord of 60° , or radius*, between the radii oc and oB , meeting them at equal distances from the center; divide the quadrant cB into six equal parts, for intervals of hours, subdividing each of these parts into 12 for intervals of 5 minutes, and further subdividing for single minutes if the circle be large enough; and from the center o draw right lines to the divisions and subdivisions of the quadrant, intersecting the chord or radius placed in the quadrant, and we shall have a scale of hours.

Prolong the touching line TC to L ; set off the scale of sines from c to L ; draw right lines from the center o to the divisions upon cL , and from the intersections of these lines with the quadrant cB draw right lines parallel to the radius oc , to meet the radius oB , and we shall have a scale of latitudes†.

Corresponding lines of hours and latitudes may also be constructed (as represented in our figure) more simply, and on a scale twice as large as by the preceding method, as follows:—

With the chord of 45° set off from B to E , and again from B to F , we obtain a quadrant EF bisected in B ; and, the chord of 60° or radius being set off from A , C , F , and E , this quadrant is divided into six equal parts. From the center o , draw straight lines through these divisions to meet the line touching the circle at B , and we shall have the line of hours.

From the point D , draw right lines through the divisions upon the line of sines oc , to meet the circumference Bc , and

* Chord of 60° is equal to radius. Euc. book iv. prop. 15, Cor.

† The line of latitudes is a line of sines, to radius equal the whole length of the line of hours, of the angles, of which the tangents are equal to the sines of the latitudes. The middle of the hour line being numbered for three o'clock, the divisions for the other hours are found by setting off both ways from the middle the tangents of $n. 15^\circ$, $n.$ being the number of hours from three o'clock, that is, one for two o'clock and four o'clock, two for one o'clock and five o'clock, and three for twelve o'clock and six o'clock.

transferring these divisions from B, as a center to the chord B c, we shall have the corresponding line of latitudes.

It is not necessary that these scales should all be projected to the same radius; but those which are used together, as the rhumbs and chords, the chords and longitudes, the sines, tangents, secants, and semitangents, and, lastly, the hours and latitudes, must be so constructed necessarily. In the accompanying diagram (plate 1, fig 2) we have laid down the hours and latitudes to a radius equal to the whole length of the scale, the other lines being laid down to the radius used in the foregoing construction.

The Line of Chords is used to set off an angle, or to measure an angle already laid down.

1st. *To set off an angle*, which shall contain D° from the point A, in the straight line A B. Open the compasses to the extent of 60° upon the line of chords, which equals the radius to which this line has been laid down (Euc. iv. prop.

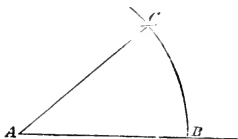

15, Cor.), and, setting one foot upon A, with this extent describe an arc cutting A B in B; then, taking the extent of D° from the same line of chords, set it off from B to c; and, joining A c, B A c is the angle required. Thus to set off an angle of 41° , having described the arc B c, as directed, with one foot of the compasses on B, and the extent of 41° on the line of chords, intersect B c in c, and join A c.

2nd. To measure the angle contained by the straight lines A B and A c already laid down. Open the compasses to the extent of 60° on the line of chords, as before, and with this radius describe the arc B c, cutting A B and A c, produced, if necessary, in the points B and c; then, extending the compasses from B to c, place one point of the compasses on the beginning, or zero point, of the line of chords, and the other point will extend to the number upon this line, indicating the degrees in the angle B A c. If, for instance, this point fall on the 41st division, or the first division beyond that marked 40 in the figure (plate 1, fig, 2), the angle B A c will contain 41° .

The Line of Rhumbs is a scale of the chords of the angles of deviation from the meridian denoted by the several points and quarter points of the compass, enabling the navigator, without computation, to lay down or measure a ship's course upon a chart. Thus, supposing the ship's course to be

N.N.E. $\frac{3}{4}$ E. Through the point A, representing the ship's place upon the chart, draw the meridian A B, and with center A and distance equal to the extent of 60° upon the line of chords describe an arc cutting A B in B; then on the line of rhumbs take the extent to the third subdivision beyond the division marked 2, because N.N.E. is the second point of the compass from the north, and with one foot of the compasses on B describe an arc intersecting B C in C: join A C, and the angle B A C will represent the ship's course. On the other hand, if a



ship is to be sailed from the point A to a point on the line A C on a chart, draw the meridian A B, describe the arc B C with radius equal to chord of 60° , as before, and the extent from B to C, applied to the line of rhumbs, will give 2 pts. 3 qrs., denoting that the ship must be sailed by the compass N.N.E. $\frac{3}{4}$ E.

The Line of Longitudes shows the number of equatorial miles in a degree of longitude on the parallels of latitude indicated by the degrees on the corresponding points of the line of chords. *Example.*—A ship in latitude 60° N. sailing E. 79 miles, required the difference of longitude between the beginning and end of her course. Opposite 60 on the line of chords stands 30 on the line of longitudes, which is, therefore, the number of equatorial miles in a degree of longitude at that latitude. Hence, as $30 : 79 :: 60 : 158$ miles, the required difference of longitude.

The Lines of Sines, Secants, Tangents, and Semitangents are principally used for the several projections, or perspective representations, of the circles of the sphere, by means of which maps are constructed. Thus, the meridians and parallels of latitude being projected, the countries intended to be represented are traced out according to their respective situations and extent, the position of every point being determined by the intersection of its given meridian and parallel of latitude.

The plane upon which the circles are to be delineated is called the primitive, and the circumference of a circle, described with a radius, representing, upon the reduced scale of the drawing, the radius of the sphere, is called the circumference of the primitive. Lines, drawn from all the points of the circles to the eye, by their intersection with the primitive form the projection.

When the eye is supposed to be infinitely distant, so that the lines of vision are parallel to one another and perpendicular to the primitive, the projection is called orthographic. When the primitive is a tangent plane to the sphere, and the eye is supposed to be at the center of the sphere, the projection is called gnomonic. When the eye is supposed to be at the surface of the sphere, and the primitive to pass through the center, so as to have the eye in its pole, the projection is called stereographic.

The projection is further termed equatorial, meridional, or horizontal, according as the primitive coincides with, or is parallel to, the equator, or the meridian or horizon of any place.

To delineate the Orthographic Projection of the Circles of the Terrestrial Sphere upon the Plane of the Meridian of any place.—With a radius according to

the contemplated scale of the projection, describe the circle $WNE S$ for the circumference of the primitive, and draw the vertical and horizontal diameters NS and WE , which will be the projections of a meridian perpendicular to the primitive, and of the equator, respectively. Take out from the line of sines the sines of the latitudes through which the parallels are to

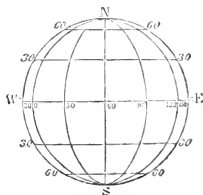

be drawn, and, reducing these sines to the radius of the primitive*, set off these reduced distances both ways from the center upon the line NS ; and also both ways from the center upon the line WE , for the sines of the angles which the meridians, to be drawn at the same intervals as the parallels, make with the meridian NS . Through the divisions thus set off, upon the line NS draw straight lines parallel to WE , and such straight lines will be the projections of the several parallels of latitude, which are to be numbered 0 to 90, from the equator to either pole for the latitudes. With distances from the center to the divisions set off upon WE as semi-minor axes, and the distance from c to N or S , equal to radius of primitive,

* If the proportional compasses be set in the proportion of the sine 90° on the line of sines to the radius of the primitive, one pair of points will give, reduced to this radius, the sines taken off by the other pair of points. The manner of taking from the sector a sine to any radius will be hereafter pointed out.

as a common major axis, describe semi-ellipses*, and they will be the projections of the several meridians, which are to be numbered either way from the first meridian for the longitudes. In the figure the primitive coincides with the plane of the meridian of a place in 30° west longitude, or 150° east longitude, the sum of these two being 180° , as must always be the case.

To delineate the Gnomonic Projection of the Circles of the Terrestrial Sphere upon a Plane parallel to the Equator.—In

this case the meridians will all be projected into straight lines, making the same angles one with another that their originals do on the surface of the sphere; the projection of the pole will be the center of the primitive, and the projections of the parallels of latitude will be circles described from the projection of the pole, as center, with distances equal to the tangents of the respective co-

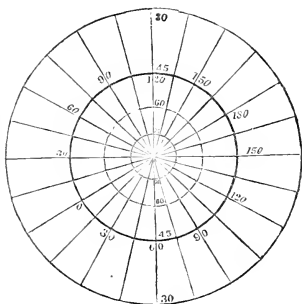

latitudes reduced to the radius of the primitive. The parallel of 45° will, therefore, coincide with the circumference of the primitive; the parallels of latitudes greater than 45° will lie within the primitive; and for latitudes less than 45° the parallels will fall without the primitive, the radii of their projections increasing as the latitude decreases, until the radius for projecting the equator becomes infinite. Describe, then, a

* These semi-ellipses may be thus described. From any point P upon the straight edge of a piece of paper set off PC equal to the major axis, and PB equal to the minor axis: then move the paper into various positions, but so that the point C may always be upon the line WE , and the point B upon the line NS , and the point P will, in every such position, coincide with a point in the required ellipse.

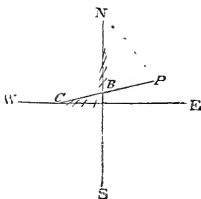

circle for the primitive; draw straight lines radiating from its center, and equally inclined one to another for the projections of equidistant meridians; and number them 0 to 180 both ways from the first meridian for the longitudes. With the tangents of the colatitudes, taken at intervals equal to the angle between two successive meridians, and reduced to the radius of the primitive, as distances, describe from the center of the primitive concentric circles; and number them 90 to 45 from the pole to the primitive for the latitudes, continuing the graduation beyond for the lower latitudes.

The gnomonic projection affords a good representation of the polar regions, but all places in latitudes lower than 60° appear greatly distorted. The gnomonic projection enlarges the representations of places at a distance from the center of projection beyond their proportionate true dimensions; and the orthographic, on the contrary, unduly contracts them; while both are adapted for representing best the countries at only a moderate distance from the center of projection.

To delineate the Stereographic Projection of the Circles of the Terrestrial Sphere upon the Horizon of any place.—With radius determined upon describe a circle for the primitive, and draw its vertical and horizontal diameters, NS and WE , which will be the projections of the meridian of the place and of the prime vertical respectively. From the center C set off upon the radius Cs , produced, if necessary, the distance Cs , equal to the tangent of the latitude of the place reduced to the radius of the primitive; and with center A and distance Aw or AE describe the circle WNE , which will be the projection of the meridian at right angles to NS , the meridian of the place; and, consequently, N will be the projection of the pole. Through A draw the right line AB at right angles to AC , and another line AD making any convenient angle with AB , and, setting off AB equal to the radius of the primitive, and AD equal to the sine of the colatitude, taken from the line of sines, join BD . Now take from the line of tangents the angles which the other meridians to be drawn are to make with the meridian WNE , or the complements of the angles which they are to make with NS , and set them off both ways from A upon the line AD ; through each of the divisions L , thus found, draw Lo , parallels to BD , and we have at o the centers of the circles for describing the meridians*. With centers o and distances ox , describe the

* The distance $AO = \frac{r \cot. L}{\cos. l}$ where r represents the radius of the pri-

meridians, and number them 0 to 180, both ways, from the first meridian, for the longitudes. For a parallel through any given latitude, take the difference of the complement of the given latitude and of the colatitude of the place from the line of semitangents, and, having reduced it to the radius of the primitive, set it off at r from c towards n for latitudes greater than the latitude of the place, and from c towards s for latitudes less than the latitude of the place: — again,

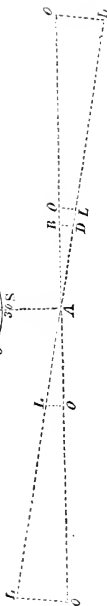
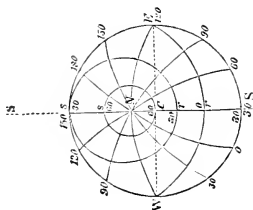

take the sum of the complement of the given latitude and of the colatitude of the place from the line of semitangents, and set it off at s from c upon $c n$ produced: then the circle described upon $r s^*$ as diameter will be the parallel required. Draw these parallels for intervals of latitude equal to the angles made by two successive meridians, and number them 90 to 0 from the pole n for the north latitudes, and again increasing from 0 on the other side of the equator for the south

primitive, l the latitude of the place, and L the angle at which the meridian is inclined to the meridian of the place.

* Diameter of parallel = $r \tan. \frac{1}{2} (c - \delta) + r \tan. \frac{1}{2} (c + \delta)$ where = colatitude of place, and δ = colatitude of parallel.

latitudes, if the place be in north latitude—or the converse, if the place be in south latitude.

The practical application of the preceding methods of projection is usually confined to the representation of an entire hemisphere, or at least of a considerable portion of a sphere; but for laying down smaller portions of the sphere the method of development may be advantageously adopted. In this method the portion of the sphere to be represented is considered as coincident with a portion of a cone, touching the sphere in a circle which is the middle parallel of latitude of the country to be represented, and this portion of the cone when developed forms a portion of a sector of a circle.

To lay down the meridians and parallels of latitude for this development. 1. Take a straight line, $B C A$, for the middle meridian of the intended map, and divide it into equal parts, to represent degrees and minutes of latitude according to the scale determined upon for the map. 2. From one of these divisions, A , which is conveniently situated to form the center of the map, set off from A to C the cotangent of the middle latitude, reduced to a radius equal to 57.3 of the divisions previously marked off as degrees, or to 3438 of those marked off as minutes. 3. With C as a center and radius $C A$, describe the arc $D A E$ for the middle parallel of latitude, and divide it into equal parts to represent degrees and minutes of longitude, the lengths of these parts having, to the lengths of the parts previously set off on the meridian for degrees and minutes of latitude, the ratio cosine of middle latitude : radius. 4. With C as center, describe concentric arcs, through the divisions on $C E$, for the parallels of latitude; and draw straight lines, radiating from C , through the divisions on $D A E$ for the meridians.

In our figure the middle latitude is 55° ; $A B$ is equal to the length of 57.3° , or the radius of the sphere;

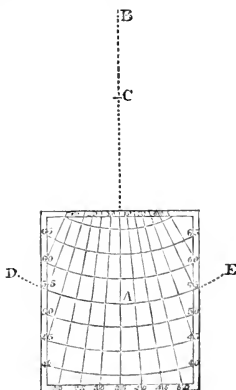

Δc is equal to the cotangent of 55 , or the tangent of 35 reduced to this radius; and c , consequently, is the center for describing the parallels, and the radiating point for the meridians.

In drawing a map of small extent, it is usual to make all the meridians and parallels of latitude straight lines; and to make the extreme parallels, and the meridian passing through the center of the map, proportional to their real magnitude.

Another and more exact method is to make the meridian passing through the center of the map, and all the parallels of latitude, straight lines, as in the last method. Then all the degrees on each of the parallels are made proportional to their magnitude, and the lines passing through the corresponding points of division on the parallels will represent the meridians. These will be curved lines, and not straight, as in the last method. This is usually called *Flamsteed's Projection*, as it was first used by that astronomer in constructing his "Celestial Atlas;" and it is extremely useful in geographical maps for countries lying on both sides of the equator.

A considerable improvement of this method, for countries of large extent, is to represent all the parallels of latitude by concentric circles, according to the principles of the conical development; and then to lay off the degrees on each parallel, proportional to their magnitude*, and draw lines through the corresponding divisions of these parallels to represent the meridians. This delineation, perhaps, will give the different parts of a map of some extent in as nearly their due proportions as the nature of the case will admit.

We will now briefly explain the manner of constructing some of the simplest dials by means of the dialling scales.

To construct a Horizontal Dial.—Draw on your dial plate two parallel

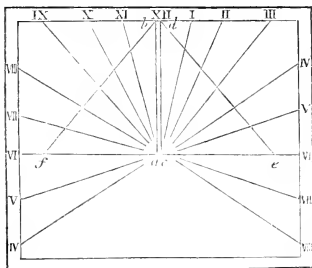

* That is, the degrees on each parallel must have to a degree of latitude the ratio of radius : cosine of the latitude of the parallel.

lines, $a b$, $c d$, as a double meridian line, at a distance apart equal to the thickness of the intended style, or gnomon. Intersect them at right angles by another line, $e f$, called the six o'clock line. From the scale of latitudes take the latitude of the place with the compasses, and set that extent from c to e and from a to f on the six o'clock line, and then, taking the whole of six hours between the parts of the compasses from the scale, with this extent set one foot in the point e , and with the other intersect the meridian line $c d$ at d . Do the same from f to b , and draw the right lines $e d$ and $f b$, which are of the same lengths as the scale of hours. Place one foot of the compasses on the beginning of the scale, and, extending the other to any hour on the scale, lay these extents off from d to e for the afternoon hours, and from b to f for the forenoon. In the same manner the quarters or minutes may be laid down, if required. The edge of a ruler being now placed on the point c , draw the first five afternoon hours from that point through the marks on the line $d e$, and continue the lines of 4 and 5 through the center c to the other side of the dial for the like hours of the morning. Lastly, lay a ruler on the point a , and draw the last five forenoon hours through the marks on the line $f b$, continuing the hour lines of 7 and 8 through the center a to the other side of the dial, for the evening hours, and figure the hours to the respective lines.

To make the Gnomon.—From the line of chords, always placed on the same dialling scale, take the extent of 60° , and describe from the center a the arc $g n$. Then with the extent of the latitude of the place, suppose London, $51\frac{1}{2}^\circ$, taken from the same line of chords, set one foot in n , and cross the arc with the other at g . From the center at a draw the line $a g$ for the axis of the gnomon $a g i$, and from g let fall the perpendicular $g i$ upon the horizontal meridian line $a n$, and there will be formed a triangle $a g i$. A plate or triangular frame similar to this triangle, and of the thickness of the interval of the parallel lines $a c$ and $b d$, being now made and set upright between them, touching at a and b , its hypotenuse or axis $a g$ will be parallel to the axis of the earth when the dial is fixed truly, and will cast its shadow on the hour of the day.

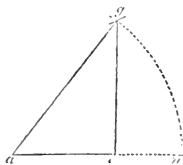

To make an erect South Dial.—Take the complement of the latitude of the place, which for London is 90° less $51\frac{1}{2} = 38\frac{1}{2}$, from the scale of latitudes, and proceed in all other respects for the hour lines, as above, for the horizontal dial; only reversing the hours, and limiting them to the 7; and for the gnomon making the angle of the style's height equal to the colatitude $38\frac{1}{2}$.

To construct an East or West Dial.—Draw the two meridian lines as before, and intersect it at right angles by another line, upon which set off, from the meridian lines, the tangents of 15° , 30° , 45° , &c., for every 15° , reduced to a radius equal to the intended height of the style. The hour lines are to be drawn through the divisions thus marked, parallel to the meridian lines, and the meridian lines themselves are six o'clock hour lines. The gnomon is a plate in the form of a parallelogram, the breadth of which forms the height of the style or gnomon, and must be equal to the radius to which the tangents have been set off on the dial plate. It is set up between the meridian lines, perpendicular to the dial plate; and the dial is set up, so that the meridian lines, and consequently the edge of the gnomon, may be parallel to the earth's axis. As the sun only shines on the dial during half the day, if the dial fronts the east, it points out the time from sunrise to noon, or, if the dial fronts the west, from noon to night.

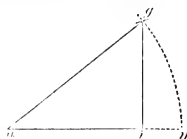
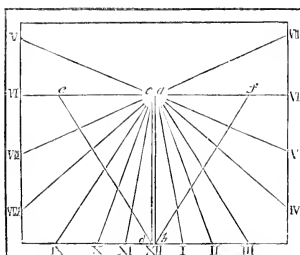

GUNTER'S LINES.

These lines are graduated so as to form a scale of the logarithms of numbers, sines, and tangents; to which are sometimes added, for the use of the navigator, lines of the logarithms of the sine rhumbs and tangent rhumbs. They may be constructed as follows:—

1. To construct the Line of Logarithmic Numbers marked N

— Having fixed upon a convenient length for the entire scale, which must be exactly equal to the length of twenty of the primary divisions of the diagonal or vernier scale, or of the beam compasses (p. 48), by which it is to be divided, bisect it, and figure it 1 at the commencement on the left hand, 1 again in the middle, and 10 at the end. The half line, then, is taken for unity, or the logarithm of 10, and, consequently, the whole line represents 2, or the logarithm of 100. The lengths corresponding to the three first figures of the logarithms of 2, 3, &c., up to 9, as found in the common table of logs., may now be taken off from the diagonal scale, or the length corresponding to four or even five figures may be estimated upon a vernier scale, or upon the beam compasses, if the scale be not less than twenty inches in length. These lengths are to be set off from the 1 at the commencement of the line for the logarithms of 2, 3, &c., to 9, and again from the 1 at the middle of the line for the logarithms of 20, 30, &c., to 90. The divisions thus formed are to be subdivided by setting off, in the same manner, the three, four, or five first figures of the logarithms of 1·1, 1·2, 1·3, &c., to 1·9; of 2·1, 2·2, 2·3, &c., to 2·9, and so on, each of the primary divisions being thus subdivided into ten; and these again are to be subdivided each into ten, or five, or two, as the length of the secondary divisions may admit, by setting off the logarithms of 1·11, 1·12, 1·13, &c.; or of 1·12, 1·14, &c.; or of 1·15, 1·25, &c.; and the scale is completed.

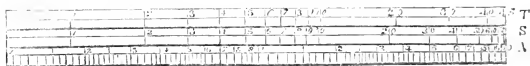

9. *To construct the Line of Logarithmic Sines marked S.*— The whole length of the scale is taken as the logarithm of the radius, and, since this extent upon the line of numbers represents 2, or the logarithm of 100, it follows that the lines of sines, tangents, &c., are to be scales of the logarithms of the sines, tangents, &c., to radius 100, of which the logarithm is 2: whereas the logarithmic tables of sines, tangents, &c., are set down to a radius, of which the logarithm is 10. By taking 8, then, from each of the tabulated values of the logarithmic sines, tangents, &c., we should obtain the logarithmic sines, tangents, &c., to radius 100, and the three, four, or five first figures of these reduced values are to be set off, from the left hand towards the right, by one of the scales, or by the

beam compasses, as explained in the construction of the line of numbers; 1st, for every 10 degrees, then for every degree, and then for every half degree, every 10 minutes, and every 5 minutes, as far as the length of the several primary divisions will admit. The line is then numbered 1, 2, 3, &c., at every degree to 10, and afterwards 20, 30, 40, &c., at every ten degrees to 90, which stands at the extreme right, since $\sin 90^\circ$ equals radius.

The tabulated logarithmic sine of $34' 23''$, being 8.0000669, will coincide, or nearly so, with the zero point upon our scale, and consequently angles smaller than this cannot be taken off from the sines. This remark applies equally to the line of tangents, the tabulated logarithmic tangent of $34' 23''$ being 8.0000886.

By taking the extents backwards from right to left, and reckoning them as forward distances, the line of sines becomes a line of cosecants*, giving us, in fact, the excesses of the logarithmic cosecants above the logarithmic radius; and, by taking the complements of the required angles, the line of sines becomes a line of cosines when measured forwards from left to right, and a line of secants when measured backwards from right to left.

3. *To construct the Line of Logarithmic Tangents marked T.*—8 being taken from each of the tabulated values of the logarithmic tangents up to 45° , the extents corresponding to these values are to be set off upon the scale, and numbered from left to right, in a similar manner to that in which the logarithmic sines were set off and numbered upon the line of logarithmic sines. The logarithmic tangent of 45° extends to the extreme right of the scale, coinciding in extent with the sine of 90 , since tangent 45° equals radius, and the logarithmic tangents of the angles from 45° to 90 are measured backwards from the extreme right to the complement of the angle required, these extents giving us, in fact, the excesses of the logarithmic tangents sought above the logarithmic radius†

$$* \text{Cosecant} = \frac{r^2}{\sin}, \text{ and sec.} = \frac{r^2}{\cos};$$

and, therefore, $\log. \text{ cosecant} = 2 \log. \text{ rad.} - \log. \text{ sine};$

or, $\log. \text{ cosecant} - \log. \text{ rad.} = \log. \text{ rad.} - \log. \text{ sine};$

and $\log. \text{ secant} = 2 \log. \text{ rad.} - \log. \text{ cos.};$

or, $\log. \text{ secant} - \log. \text{ rad.} = \log. \text{ rad.} - \log. \text{ cos.}$

$$\dagger \text{Tan.} = \frac{r^2}{\text{cotan.}} = \frac{r^2}{\text{tan. of compt.}};$$

$\therefore \log. \text{ tan.} = 2 \log. \text{ rad.} - \log. \text{ tan. of compt.};$

or, $\log. \text{ tan.} - \log. \text{ rad.} = \log. \text{ rad.} - \log. \text{ tan. of compt.}$

When, then, the angle is greater than 45, the distance from radius to the angle, though measured backwards upon the scale, must be reckoned a forward distance, and *vice versâ*.

The lines of logarithmic sine rhumbs, marked S.R., and tangent rhumbs, marked T.R., are formed in the same way as the lines of logarithmic sines and tangents, but are set off for the angles corresponding to the points and quarter points of the compass, instead of for degrees and minutes.

We shall now proceed to explain the uses of Gunter's lines.

1. *The Line of Logarithmic Numbers.*—The primary divisions upon this line, as explained in its construction, represent the logarithms of all the integers from 1 to 100, while the extents to the first subdivisions will indicate tenths of an unit from the beginning of the scale to 1 in the middle, and units from 1 in the middle to 10 at the end, where the figures 2, 3, &c., stand for 20, 30, &c., as has been explained in the construction. If any of the subdivisions be further subdivided into ten parts, each of these last divisions will indicate hundredths of an unit from 1 at the beginning to 1 in the middle, and tenths of an unit from 1 in the middle to 10 at the end. Upon pocket sectors (p. 34), however, upon which Gunter's lines are now usually placed, affording a greater extent for the purpose than the six-inch plain scale (p. 33), only the part from 1 in the middle to 2 towards the right is a second time divided, and that but into five parts instead of ten, every one of which must be accounted as two-tenths. By this line the multiplication and division of numbers of any denomination either whole or fractional may be readily accomplished, questions in proportion solved, and all operations approximatively performed with great rapidity, which can be performed by the common table of logarithms; but the numbers sought must always be supposed to be divided or multiplied by 10 as many times as will reduce them to the numbers, the logarithms of which are actually set off upon the line of numbers, and these tens must be mentally accounted for in the result.

Multiplication is performed by extending from 1 on the left to the multiplier; and this extent will reach forwards from the multiplicand to the product. Thus, if 125 were given to be multiplied by 250, extend the compasses from 1 at the left hand to midway between the second and third subdivision, in the first primary division from 1 to 2, for the 125. This extent is really the logarithm of 125. Set off this extent towards the right from the fifth subdivision after the primary division marked 2, which is taken to represent

the log. of 250, but is really the log. of 2.5, and the compasses will reach to a quarter of the next subdivision beyond the first subdivision after the primary division marked 3. The extent to this point is really the logarithm of 3.125; but in this case it represents the number 31250, because two powers of ten have been cast out from both the multiplier and multiplicand, and therefore the product must be multiplied by the product of four tens, or ten thousand; or, in other words, the first figure of the product must be reckoned as so many tens of thousands.

Division, being the reverse of multiplication, is performed by extending from 1 on the left to the divisor; and this extent will reach backwards from the dividend to the quotient. Thus, if 31250 were to be divided by 250, extend the compasses from 1 on the left to 2.5, and this extent will reach backwards from 3.125 to 1.25. Then, since the divisor contained 2 powers of ten and the dividend 4, the quotient must contain 2, and therefore the result is 125.

Proportion being performed by multiplication and division, extend the compasses from the first term to the second, and this extent will reach from the third to the fourth, taking care to measure in the same direction, so that, if the first be greater than the second, the third may be greater than the fourth, and *vice versá*. *Example*.—If the diameter of a circle be 7 inches, and the circumference 22, what is the circumference of another circle, the diameter of which is 10? Extend the compasses from 7 to 10, and this extent will reach from 22 to 31.4, or nearly $31\frac{1}{2}$ inches, the circumference required.

The same thing may also be performed by extending from the first term to the third, and this extent will reach from the third term to the fourth (Euc. v. prop. 16). Thus, the extent from 7 to 22 will reach from 10 to 31.4, as before.

To measure a Superficies, extend from 1 to either the breadth or length, both being reduced to the same denomination, and this extent will reach forwards from the length or breadth to the superficial content. *Example*.—Required the superficial content of a plank 27 feet long by 15 inches broad. Extend from 1 to 1.25, for 15 inches equals 1.25 feet, and this extent will reach from 27 feet to 33.75 feet, the superficial content required.

Second Method.—Extend from 12 to the number of inches in the breadth, and this extent will reach in the same direction from the number of feet in the length to the number of square feet in the superficial content. Thus the extent for-

wards from 12 to 15 will reach forwards from 27 to 33.75, as before; while the extent backwards from 12 to 9 will reach backwards from 27 to 20.25 or $20\frac{1}{4}$, showing the superficial content of a plank 27 feet long by 9 inches broad to be 20.25 or $20\frac{1}{4}$ feet.

To measure a Solid Content.—The breadth, depth, and length being all reduced to the same denomination, extend from 1 to either the breadth or depth, and this extent will reach from the depth or breadth forwards to a fourth number, which will represent the superficial content of the section at the place measured: then, if the breadth and depth be the same throughout the entire length, the extent from 1 to the superficial content thus found will reach forwards from the length to the solid content. *Example.*—What is the solid content of a pillar 1 foot 3 inches square, and 21 feet 9 inches long? The extent from 1 to 1.25 reaches forward from 1.25 to 1.56, the superficial content of a section of the pillar; and the extent from 1 to 1.56 reaches from 21.75 to 34, or more accurately to 33.93, the solid content in feet*.

2. *The Lines of Logarithmic Sines and Tangents.*—These lines are generally used, in connection with the line of numbers, for solving all proportions in which any of the terms are functions of angles, as sines, tangents, &c., and, in fact, all questions in which such quantities appear as factors or divisors. We will exemplify their use by giving the solution, by their aid, of the several cases of right-angled trigonometry.

Case 1†. The hypotenuse and angles being given, to find the perpendicular and base.

* Our limits forbid us from entering further upon the uses of the line of logarithmic numbers; but the student will, we hope, from what he sees here, be easily enabled to apply it to every case of mensuration, and, in short, to almost every arithmetical operation. Additions and subtractions, however, cannot be performed by it.

† These cases are, in fact, the solutions, by the aid of Gunter's lines, of the following proportions, which will be obvious to the student upon inspection of the accompanying figure.

Rad. : sin. A :: AB : BC	}	Case 1.
Rad. : sin. B :: AB : AC		
Sin. B : rad. :: AC : AB	}	Case 2.
Sin. A : sin. B :: AC : BC		
Rad. : tan. A :: AC : BC	}	Case 3.
AB : AC :: rad. : sin. B		
Rad. : sin. A :: AB : BC	}	Case 4.
AC : BC :: rad. : tan. A		
BC : AC :: rad. : tan. B	}	
Sin. A : rad. :: BC : AB		

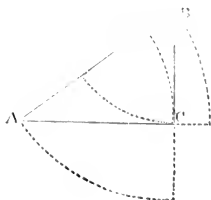

Note.—One acute angle of a right-angled triangle being the complement of the other, or the sum of the two acute angles being equal to 90° , when one of the acute angles is given, the other is also given.

Solution.—Extend the compass from 90° , or radius, on the line of sines to the number of degrees in either of the acute angles, and that extent will reach backwards, on the line of numbers, from the hypotenuse to the side opposite this angle. *Example.*—Given the hypotenuse $AB = 250$, and the angle $A = 35^\circ 30'$.



	$90^\circ 0'$
Extend from 90° to $35^\circ 30'$ on the line of sines, and this extent will reach from 250 to 145 on the line of numbers	$BAC = 35 \ 30$
Extend from 90° to $54^\circ 30'$ on the line of sines, and this extent will reach from 250 to 203.5 on the line of numbers	$ABC = 54 \ 30$ $\therefore BC = 145$
	$\therefore AC = 203.5$

Case 2. The angles, and one side being given, to find the hypotenuse, and the other side.

Solution.—Extend from the angle opposite the given side to 90° , or radius, on the line of sines, and this extent will reach forwards from the given side to the hypotenuse on the line of numbers. Again, extend from the angle opposite the given side to the angle opposite the required side, and this extent will reach in the same direction on the line of numbers, from the given side to the required side. Or, extend from radius, or 45° , on the line of tangents, to the angle opposite the required side, and the extent will reach, in the same direction on the line of numbers, from the given side to the required side; recollecting that, when the angle is greater than 45° , the extent is to be taken on the scale backwards from rad. or 45° to the complement of the angle, but is to be reckoned a forward distance, the logarithmic tangents of angles greater than 45° exceeding the logarithmic tangents of 45° , or radius, by as much as the logarithmic tangents of their complements fall short of it.

Example.—Given the angle $A = 35^\circ 30'$ and side $AC = 203.5$.

	$90^\circ 0'$
Extend from $54^\circ 30'$ to 90° , or rad., upon the line of sines, and this extent will reach forwards from 203.5 to 250 on the line of numbers	$BAC = 35 \ 30$
Again, extend from $54^\circ 30'$ backwards to $35^\circ 30'$, on the line of sines, and this extent will reach backwards from 203.5 to 145 on the line of numbers	$ABC = 54 \ 30$ $\therefore AB = 250$
Or extend backwards from 45° , rad., to $35^\circ 30'$ on the line of tangents,	$\therefore BC = 145$

and this extent will reach backwards from 203·5 to 145 on the line of numbers, as before*.

Case 3. The hypotenuse and one side being given, to find the angles and the other side.

Solution.—Extend from the hypotenuse to the given side on the line of numbers, and this extent will reach from 90° on rad. to the angle opposite the given side upon the line of sines. The other angle is the complement of this. Extend upon the line of sines from the rad. to the angle last found, which is opposite the required side, and this extent will reach from the hypotenuse to the required side. *Example.*—Given the hypotenuse $AB = 250$, and the side $AC = 203\cdot5$.

Extend backwards from 250 to 203·5 on the line of numbers, and this extent will reach from 90° to 54° 30' on the line of sines $\therefore \angle ABC = 54\ 30$

Extend from 90 to 35° 30' on the line of sines, and this extent will reach backwards from 250 to 145 on the line of numbers $\therefore \angle BAC = 35\ 30$
 $\therefore BC = 145$

Case 4. The two sides being given, to find the angles and the hypotenuse.

Solution.—Extend from one side to the other upon the line of numbers, and this extent will reach backwards upon the line of tangents from rad. to the least angle, and to the same point, considered as a forward distance, representing the greatest angle, which is the complement of the least. Again, extend on the line of sines from one of the angles just found to rad., and this extent will reach from the side opposite the angle taken to the hypotenuse. *Example.*—Given $AC = 203\cdot5$ and $BC = 145$.

Extend backwards upon the line of numbers from 203·5 to 145, and this extent will reach backwards from 45° to 35° 30' on the line of tangents, which is the angle opposite the side 145 $\therefore \angle BAC = 35\ 30$

If we measure forwards from 145 to 203·5, then from rad. to 35° 30' is to be considered a forward distance, and the angle to be taken as the complement of 35° 30', that is, 54° 30', which is the angle opposite the side 203·5 $\therefore \angle ABC = 54\ 30$

Again, extend from 33° 38' to 90° on the line of sines, and this extent will reach from 145 to 250 upon the line of numbers $\therefore AB = 250$

* The property that $\tan. : \text{rad.} :: \text{sine} : \text{cosine}$, may be made a test of the accuracy of the scale, since the distance from 45 to any angle upon the line of tangents ought to be the same as the distance from the angle to its complement upon the line of sines.

THE PLAIN SCALE.

One of these instruments is represented in the annexed figure, being such a one as is usually supplied with a pocket case of instruments. It is made of ivory, six inches long, and one inch and three quarters broad. On the face of the instrument represented in the engraving, a protractor is formed round three of its edges for readily setting off angles. In

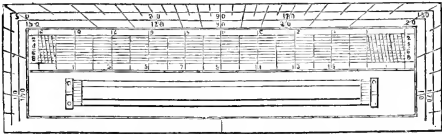

using this protractor, the fourth edge, which is quite plain, with the exception of a single stroke in the middle, is to be made to coincide with the line from which the angle is to be set off, and the stroke in the middle with the point in this line, at which the angle is to be set off; a mark is then to be made with the pricking point, at the point of the paper which coincides with the stroke on the protractor, marked with the number of degrees in the angle required to be drawn; and, the protractor being now removed, a straight line is to be drawn through the given point in the given line and the point thus pricked off. The instrument has on the same face the two diagonal scales already described (p. 10), and on the opposite face scales of equal parts, and several of the protracting scales already described (pp. 14-16), according to the purposes to which the scale is to be applied: thus, for laying down an ordinary survey, we merely require scales of equal parts, and a line of chords, and these consequently are all the lines placed on many of the instruments in the pocket cases; but for projecting maps, lines of sines, tangents and semitangents are required; for dialling, the dialling lines; and for the purposes of the navigator, the lines of rhumbs, and longitudes, the whole of Gunter's lines already described, and two lines of meridional, and equal parts to be used together in laying down distances, &c., upon Mercator's charts. The plain scale is sometimes fitted with rollers, as represented in our engraving, making it at the same time a convenient small parallel rule.

THE SECTOR.

This valuable instrument may well be called an universal

scale. By its aid all questions in proportion may be solved; lines may be divided either equally or unequally into any number of parts that may be desired; the angular functions, viz., chords, sines, tangents, &c., may be set off or measured to any radius whatever; plans and drawings may be reduced or enlarged in any required proportion; and, in short, every operation in geometrical drawing may be performed by the aid of this instrument and the compasses only.

The name sector is derived from the tenth definition of the third Book of Euclid, in which this name is given to the figure contained by two radii of a circle, and the circumference between them. The instrument consists of two equal rulers, called legs, which represent the two radii, moveable about the center of a joint, which center represents the center of the circle. The legs can consequently be opened so as to contain any angle whatever, or completely opened out until their edges come into the same straight line.

Sectors are made of different sizes, and their length is usually denominated from that of the legs when shut together. Thus, a sector of six inches, such as is supplied in the common pocket cases of instruments, forms a rule of twelve inches, when opened; and this circumstance is taken advantage of, by filling up the spaces not occupied by the sectoral lines with such lines as it is most important to lay down upon a greater length than the six-inch plain scale will admit. Among these the most usual are (1) the lines of logarithmic numbers, sines, and tangents already described (pp. 25-28); (2) a scale of 12 inches, in which each inch is divided into ten equal parts; and (3) a foot divided into ten equal primary divisions, each of which is subdivided into ten equal parts, so that the whole is divided into 100 equal parts. The last-mentioned is called the decimal scale, and is placed on the edge of the instrument.

The *sectoral lines* proceed in pairs from the center, one line of each pair on either leg, and are, upon one face of the instrument, a pair of scales of equal parts, called the *line of lines*, and marked L; a pair of lines of chords, marked c; a pair of lines of secants, marked s; a pair of lines of polygons, marked POL.



Upon the other face, the sectoral lines are—a pair of lines of sines, marked *s*; a pair of lines of tangents up to 45° , marked *t*; and a second line of tangents to a lesser radius, extending from 45° to 75° .

Each pair of sectoral lines, except the line of polygons, should be so adjusted as to make equal angles at the center, so that the distances from the center to the corresponding divisions of any pair of lines, and the transverse distance between these divisions, may always form similar triangles. On many instruments, however, the pairs of lines of secants, and of tangents from 45° to 75° , make angles at the center equal to one another, but unequal to the angle made by all the other pairs of lines.

The solution of questions on the sector is said to be *simple*, when the work is begun and ended upon the same pair of lines; *compound*, when the operation is begun upon one pair of lines and finished upon another.

In a compound solution the two pairs of lines used must make equal angles at the center, and, consequently, in the exceptional case mentioned above, the lines of secants and of tangents above 45° cannot be used in connection with the other sectoral lines*.

When a measure is taken on any of the sectoral lines beginning at the center, it is called a *lateral distance*; but, when a measure is taken from any point on one line to its corresponding point on the line of the same denomination on the other leg, it is called a *transverse* or *parallel distance*.

The divisions of each sectoral line are contained within three parallel lines, the *innermost* being the line on which the points of the compasses are to be placed, because this is the only line of the three which goes to the center, and is therefore the sectoral line.

On the Principle of the Use of the Sectoral Lines.—1st. *In the case of a Simple Solution.*—Let the lines *A B*, *A C* represent a pair of sectoral lines,

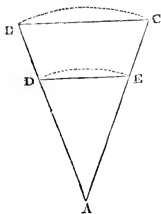

* Since, however, $\text{secant} : \text{rad.} :: \text{rad.} : \text{cosine}$;
and $\text{tangent} : \text{rad.} :: \text{rad.} : \text{cotangent}$;

the line of sines may be used with the other sectoral lines in place of the line of secants, and the line of tangents less than 45° in place of the line of tangents greater than 45° , the complements of the angles being taken upon these lines, in either case, instead of the angles themselves. See page 41.

and BC, DE , any two transverse distances taken on this pair of lines; then, from the construction of the instrument, we have AB equal to AC , and AD equal to AE , so that $AB : AC :: AD : AE$, and the triangles ABC and ADE have the angle at A common, and the sides about this common angle proportional (Euc. vi. prop. 6); they are, therefore, similar and—

$$AB : BC :: AD : DE.$$

In the case of a compound solution, the angles at A are equal, but not common, and the reasoning is, in all other respects, exactly the same.

USES OF THE LINE OF LINES.

To find a Fourth Proportional to three given Lines.—Set off from the center a lateral distance equal to the first term, and open the sector till the transverse distance at the division thus found, expressing the first term, is equal to the second term; again, extend to a point whose lateral distance from the center is equal to the third term, and the transverse distance at this point will be the fourth term required.

If the legs of the sector will not open far enough to make the lateral distance of the second term a transverse distance at the division expressing the first term, take any aliquot part of the second term, which can conveniently be made such transverse distance, and the transverse distance at the third term will be the same aliquot part of the fourth proportional required.

A third proportional to two given lines is found by taking a third line equal to the second, and finding the fourth proportional to the three lines.

Example.—To find a fourth proportional to the numbers 2, 5, and 10. Open the sector till the lateral distance of the second term 5 becomes the transverse distance at 2, the first term; then the transverse distance at 10 will extend, as a lateral distance, from the center to 25, the fourth proportional required.

To bisect a given Straight Line.—Take the extent of the line in the compasses, and open the sector till this extent is a transverse between 10 and 10 on the line of lines: then the transverse distance from 5 to 5, on the same pair of sectoral lines, gives the half of the line, and this extent set off from either end will bisect it.

To divide a Straight Line into any Number of equal Parts.—

1. When the number of parts are a power of 2, the operations

are best performed by continual bisection. Thus, let it be required to divide the line AB into sixteen equal parts.

1. Make AB a transverse distance between 10 and 10 on the line of lines; then take off the transverse distance of 5 and 5, and set it off from A or* B to 8, and AB will be divided into two equal parts at the division 8. 2. Make AS a transverse distance at 10, and then the transverse distance at 5, set off from A or* S at 4, and from B or* S at 12, will divide the line into four equal parts at the divisions 4, 8, and 12. 3. Make the extent AS a transverse distance at 10, and the transverse distance at 5 will again bisect each of the parts last set off, and divide the whole line into eight equal parts at the divisions 2, 4, 6, 8, 10, 12, and 14. Each of these may be again bisected by taking the transverse distance at $2\frac{1}{2}$ or $2\cdot5$, that is, at the middle division between the 2 and the 3 upon the line of lines, and the line will be divided as required.

When the divisions become smaller than can be conveniently bisected by the method just explained, the operation may still be continued to any required extent by taking the extent of an odd number of the divisions already obtained as the transverse distance of 10 and 10, and setting off the half of this extent, or the transverse distance at 5, from the several divisions already obtained. Thus, in the preceding example, by making the extent of three of the divisions, or five, or seven, a transverse distance at 10, the transverse distance at 5, set off from the several divisions already obtained, will divide AB into 32 equal parts.

2. When the number of parts is not a power of 2, the operations cannot all be performed by bisections; but still, by a judicious selection of the parts into which the line is first divided, many of the after operations may be performed by bisections. *Example.*—Let it be required to divide the line

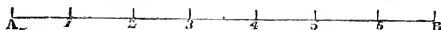

AB into seven equal parts. 1. Make the whole extent, AB , a transverse distance between 7 and 7 on the line of lines; then

* Greater accuracy is obtained by setting off the distance from both ends of the extent to be bisected, and then, in case the two points so found do not accurately coincide, taking the middle point between them, as near as the eye can judge, for the true point of bisection.

take off the transverse distance of 4 and 4, and set it off from A and B to 4 and 3. 2. Make this extent from A to 4 a transverse distance at 10; then the transverse distance at 5 bisects A 4 and 3 B in 2 and 5; set off from 3, gives 1, and from 4 gives 6; and thus the line A B is divided into seven equal parts as required.

To open the Sector so that the Line of Lines may answer for any required Scale of equal Parts.—Take one inch in the compasses, and open the sector, till this extent becomes a transverse distance at the division indicating the number of parts in an inch of the required scale; or, if there be not an integral number of parts in one inch, it will be better to take such a number of inches as will contain an integral number of parts, and make the extent of this number of inches, if it be not too great, a transverse distance at the division indicating the number of parts of the required scale in this extent.

Example.—*To adjust the Sector as a Scale of One Inch to Four Chains.*—Make one inch the transverse distance of 4 and 4; then the transverse distances of the other corresponding divisions and subdivisions will represent the number of chains and links indicated by these divisions: thus, the transverse distance from 3 to 3 will represent three chains; the transverse distance at 4·7, or the seventh principal subdivision after the primary division marked 4, will represent 4 chains 70 links, and so on.

To construct a Scale of Feet and Inches in such a manner that an extent of Three Inches shall represent Twenty Inches.—1. Make three inches a transverse distance between 10 and 10, and the transverse distance of 8 and 8 will represent 16 inches. 2. Set off this extent from A to B, divide it by continual bisection into 16 equal parts, and place permanent strokes to mark the first 12 of these divisions, which will represent inches. 3. Place the figure 1 at the twelfth stroke, and set off again the extent of the whole 12 parts, from 1 to 2, 2 to 3, &c., to represent the feet.

As an Example of the Use of the Line of Lines in reducing Lines, let it be required to reduce a drawing in the Proportion of 5 to 8.—Take in the compasses the distance between two points of the drawing, and make it a transverse distance at 8 and 8; then the transverse distance of 5 and 5 will be the distance between the two corresponding points of the copy. 2. These two points having been laid down, make the distance between one of them and a third point a transverse distance at 8, and with the transverse distance at 5 describe, from

that point as center, a small arc. 3. Repeat the operation with the other point, and the intersection of the two small arcs will give the required position of the third point in the copy. In the same manner all the other points of the reduced copy may be set off, each one from two points previously laid down.

LINE OF CHORDS.

The double scales of chords upon the sector are more generally useful than the single line of chords described on the plain scale; for, on the sector, the radius with which the arc is to be described may be of any length between the transverse distance of 60 and 60 when the legs are close, and that of the transverse of 60 and 60 when the legs are opened as far as the instrument will admit of: but, with the chords on the plain scale, the arc described must be always of the same radius.

To protract or lay down a right-lined Angle BAC , *which shall contain a given number of Degrees, suppose* 46° .—*Case 1.* When the angle contains less than 60° , make the transverse distance of 60 and 60 equal to the length of the radius of the circle, and with that opening describe the arc BC . (Fig. at page 40.) Take the transverse distance of the given degrees 46, and lay this distance on the arc from the point B to C . From the center A of the arc draw two lines AC , AB , each passing through one extremity of the distance BC laid on the arc; and these two lines will contain the angle required. *Case 2.* When the angle contains more than 60° . Suppose, for example, we wish to form an angle containing 148° . Describe the arc BCD , and make the transverse distance of 60 and 60 equal the radius as before. Take the transverse distance of $\frac{1}{2}$ or $\frac{1}{3}$, &c., of the given number of degrees, and lay this distance on the arc twice or thrice, as from B to a , a to b , and from b to D . Draw two lines connecting B to A , and A to D , and they will form the angle required.

When the required angle contains less than 5° , suppose $3\frac{1}{2}$, it will be better to proceed thus. With the given radius, and from the center A , describe the arc DC ; and from some point, D , lay off the chord of 60° , which suppose to give the point G , and also from the same point D lay off in the same direction the chord of $56\frac{1}{2}^\circ$ ($= 60^\circ - 3\frac{1}{2}^\circ$), which would give the point E . Then through these two points E and G , draw

lines to the point A, and they will represent the angle of $3\frac{1}{2}^{\circ}$ as required.

From what has been said about the protracting of an angle to contain a given number of degrees, it will easily be seen how to find the degrees (or measure) of an angle already laid down.

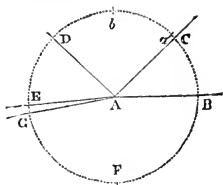

LINE OF POLYGONS.

The line of polygons is chiefly useful for the ready division of the circumference of a circle into any number of equal parts from 4 to 12; that is, as a ready means to inscribe regular polygons of any given number of sides, from 4 to 12, within a given circle. To do which, set off the radius of the given circle (which is always equal to the side of an inscribed hexagon) as the transverse distance of 6 and 6, upon the line of polygons. Then the transverse distance of 4 and 4 will be the side of a square; the transverse distance between 5 and 5, the side of a pentagon; between 7 and 7, the side of a heptagon; between 8 and 8, the side of an octagon; between 9 and 9, the side of a nonagon, &c., all of which is too plain to require an example.

If it be required to form a polygon, upon a given right line set off the extent of the given line, as a transverse distance between the points upon the line of polygons, answering to the number of sides of which the polygon is to consist; as for a pentagon between 5 and 5; or for an octagon between 8 and 8; then the transverse distance between 6 and 6 will be the radius of a circle whose circumference would be divided by the given line into the number of sides required.

The line of polygons may likewise be used in describing, upon a given line, an isosceles triangle, whose angles at the base are each double that at the vertex. For, taking the given line between the compasses, open the sector till that extent becomes the transverse distance of 10 and 10, then the transverse distance of 6 and 6 will be the length of each of the two equal sides of the isosceles triangle.

All regular polygons, whose number of sides will exactly divide 360 (the number of degrees into which all circles are supposed to be divided) without a remainder, may likewise be set off upon the circumference of a circle by the line of chords.

Thus, take the radius of the circle between the compasses, and open the sector till that extent becomes the transverse distance between 60 and 60 upon the line of chords; then, having divided 360 by the required number of sides, the transverse distance between the numbers of the quotient will be the side of the polygon required. Thus for an octagon, take the distance between 45 and 45; and for a polygon of 36 sides take the distance between 10 and 10, &c.

LINES OF SINES, TANGENTS, AND SECANTS.

Given the Radius of a Circle (suppose equal to two inches); required the Sine and Tangent of $28^{\circ} 30'$ to that Radius.—Open the sector, so that the transverse distance of 90 and 90 on the sines, or of 45 and 45 on the tangents, may be equal to the given radius, viz., two inches; then will the transverse distance of $28^{\circ} 30'$, taken from the sines, be the length of that sine to the given radius, or, if taken from the tangents, will be the length of that tangent to the given radius.

But, if the Secant of $28^{\circ} 30'$ is required, make the given radius of two inches a transverse distance of 0 and 0, at the beginning of the line of secants, and then take the transverse distance of the degrees wanted, viz., $28^{\circ} 30'$.

A Tangent greater than 45° (suppose 60°) is thus found:—Make the given radius, suppose two inches, a transverse distance to 45 and 45, at the beginning of the line of upper tangents, and then the required degrees (60) may be taken from the scale.

The tangent, to a given radius, of any number of degrees greater than 45° can also be taken from the line of lower tangents, if the radius can be made a transverse distance to the complement of those degrees on this line (see note, page 35).

Example.—To find the tangent of 78° to a radius of two inches. Make two inches a transverse distance at 12 on the lower tangents, then the transverse distance of 45 will be the tangent of 78° .

In like manner the secant of any number of degrees may be taken from the sines, if the radius of the circle can be made a transverse distance to the complement of those degrees upon this line. Thus making two inches a transverse distance to the sine of 12° , the transverse distance of 90 and 90 will be the secant of 78° .

To find, by means of the lower tangents and sines, the degrees answering to a given line, greater than the radius which expresses the length of a tangent or secant to a given radius.

For a tangent, make the given line a transverse distance at 45 on the lower tangents; then take the extent of the given radius, and apply it to the lower tangents; and the complement of the degrees at which it becomes a transverse distance will be the number of degrees required. For a secant make the given line a transverse distance at 90 on the sines; then the extent of the radius will be a transverse distance at the complement of the number of degrees required.

Given the Length of the Sine, Tangent, or Secant of any Degrees, to find the Length of the Radius to that Sine, Tangent, or Secant.—Make the given length a transverse distance to its given degrees on its respective scale. Then,

If a sine	}	the trans-	}	will be				
If a tangent under 45°					}	the ra-		
If a tangent above 45°							}	dius
If a secant								
	verse dis-	(90 and 90 on the sines)					
	tance of	45 and 45 on the tangents)					
		45 and 45 on the upper tangents)					
		0 and 0 on the secants)					

To find the Length of a versed Sine, to a given Number of Degrees, and a given Radius.—1. Make the transverse distance of 90 and 90 on the sines equal to the given radius. 2. Take the transverse distance of the sine of the complement of the given number of degrees. 3. If the given number of degrees be less than 90, subtract the distance just taken, viz., the sine of the complement, from the radius, and the remainder will be the versed sine: but, if the given number of degrees are more than 90, add the complement of the sine to the radius, and the sum will be the versed sine.

To open the legs of a Sector, so that the corresponding double Scales of Lines, Chords, Sines, and Tangents may make each a right Angle.—On the line of lines make the lateral distance 10, a transverse distance between 8 on one leg, and 6 on the other leg.

On the line of sines make the lateral distance 90, a transverse distance from 45 to 45; or from 40 to 50; or from 30 to 60; or from the sine of any degree to their complement.

On the line of sines make the lateral distance of 45 a transverse distance between 30 and 30.

MARQUOIS'S SCALES. (Plate II. Fig. 3.)

These scales consist of a right-angled triangle, of which the hypotenuse or longest side is three times the length of the shortest, and two rectangular rules. Our figure, which is drawn one-third the actual size of the instruments from which

it is taken, represents the triangle and one of the rules, as being used to draw a series of parallel lines. Either rule is one foot long, and has, parallel to each of its edges, two scales one placed close to the edge and the other immediately within this, the outer being termed the artificial, and the inner, the natural scale. The divisions upon the outer scale are three times the length of those upon the inner scale, so as to bear the same proportion to each other that the longest side of the triangle bears to the shortest. Each inner, or natural scale, is, in fact, a simply divided scale of equal parts (see p. 9), having the primary divisions numbered from the left hand to the right throughout the whole extent of the rule. The first primary division on the left hand is subdivided into ten equal parts, and the number of these subdivisions in an inch is marked underneath the scale, and gives it its name. On one of the pair of Marquois's scales now before us, we have, on one face, scales of 30 and 60, on the obverse scales of 25 and 50, and on the other we have on one face scales of 35 and 45, and on the obverse scales of 20 and 40. In the artificial scales the zero point is placed in the middle of the edge of the rule, and the primary divisions are numbered both ways from this point to the two ends of the rule, and are, every one, subdivided into ten equal parts, each of which is, consequently, three times the length of a subdivision of the corresponding natural scale.

The triangle has a short line drawn perpendicular to the hypotenuse near the middle of it, to serve as an index or pointer; and the longest of the other two sides has a sloped edge.

To draw a Line parallel to a given Line, at a given Distance from it.—1. Having applied the given distance to the one of the natural scales which is found to measure it most conveniently, place the triangle with its sloped edge coincident with the given line, or rather at such small distance from it, that the pen or pencil passes directly over it when drawn along this edge. 2. Set the rule closely against the hypotenuse, making the zero point of the corresponding artificial scale coincide with the index upon the triangle. 3. Move the triangle along the rule, to the left or right, according as the required line is to be above or below the given line, until the index coincides with the division or subdivision corresponding to the number of divisions or subdivisions of the natural scale, which measures the given distance; and the line drawn

along the sloped edge in its new position will be the line required*.

Note.—The natural scale may be used advantageously in setting off the distances in a drawing, and the corresponding artificial scale in drawing parallels at required distances.

To draw a Line perpendicular to a given Line from a given Point in it.—1. Make the shortest side of the triangle coincide with the given line, and apply the rule closely against the hypotenuse. 2. Slide the triangle along the rule until a line drawn along the sloped edge passes through the given point; and the line so drawn will be the line required.

The advantages of Marquois's scales are: 1st, that the sight is greatly assisted by the divisions on the artificial scale being so much larger than those of the natural scale to which the drawing is constructed; 2nd, that any error in the setting of the index produces an error of but one-third the amount in the drawing.

If the triangle be accurately constructed, these scales may be advantageously used for dividing lines with accuracy and despatch; our figure, as well as the sliding rule (fig. 4), was drawn by the aid of Marquois's scales alone.

We proceed to explain a method which we have found to answer well for dividing lines with accuracy and despatch, and which is altogether independent of any error in the construction of the triangle.

Let ab represent the line to be divided into any number, n , of equal parts; select one of the natural scales, of which n divisions or some multiple $p n$ of n divisions, are nearly equal to ab , but less than it; then setting the sloped edge of the triangle perpendicular to ab , so that a line drawn along it passes through a , place the rule closely against the hypotenuse, making a division of the artificial scale, corresponding

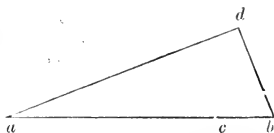

* If ABC represent the triangle in its new position, and the dotted lines represent its original position, we have, by similar triangles, $ABC, A'AD$,

$$AD : AA' :: BC : BA \\ :: 1 : 3;$$

and therefore AD contains as many divisions of the natural as AA' contains of the artificial scale.

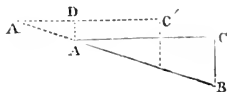

to the selected natural scale, coincide with the index upon the triangle; and, moving the triangle along to the rule to the right, until the index coincides with the p th division from that to which it was set, draw a line along the sloped edge intersecting ab in c . Upon ab as hypotenuse describe the right-angled triangle abd , having the side ad equal to ac , and placing the sloped edge of the triangle perpendicular to ad , so that a line drawn along it passes through a or d ; slide the triangle along the rule to the right or left, and drawing a line as the index comes into contact with every p th division of the artificial scale, the line will be divided as required.

THE VERNIER. (Plate II. Figs. 1 and 2.)

The property of this ingenious little subsidiary instrument will be readily comprehended from what has been already said of the construction and use of a vernier scale (p. 11). It is so constructed as to slide evenly along the graduated limb of an instrument, and enables us to measure distances, or read off observations, with remarkable nicety. In the vernier scale before described, the divisions on the lower or subsidiary scale were longer than those on the upper or primary scale; but in the vernier now to be described the divisions are usually shorter than those upon the limb to which it is attached, the length of the graduated scale of the vernier being exactly equal to the length of a certain number ($n - 1$) of the divisions upon the limb, and the number (n) of divisions upon the vernier being one more than the number upon the same length of the limb.

Let, then, L represent the length of a division upon the limb, and v , the length of a division upon the vernier:

so that $(n - 1)L = nv$;

$$\text{and therefore } L - v = L - \frac{n - 1}{n}L = \frac{1}{n}L;$$

or the defect of a division upon the vernier from a division upon the limb is equal to the n th part of a division upon the limb, n being the number of divisions upon the vernier*.

* If n divisions of the vernier were equal to $(n + 1)$ divisions of the limb,

$$\text{or } (n + 1)L = nv,$$

$$\text{then would } v - L = \frac{n + 1}{n}L - L = \frac{1}{n}L;$$

or the excess of a division upon the vernier above a division upon the limb would be equal to the n th part of a division upon the limb. With this arrangement, however, we should have the inconvenience of reading the vernier backwards.

In fig. 1, six divisions of the vernier are equal to five divisions of the limb, and, consequently, the above defect, or $L - v$, is equal to a sixth part of a division upon the limb, or to $20'$, since a division of the limb is equal to 2° .

In fig. 2, ten divisions of the vernier are equal to nine divisions of the limb, and, consequently, $L - v$ is equal to a tenth part of a division upon the limb, or to the hundredth part of an inch, a division of the limb being equal to the tenth part of an inch.

In reading off we must first look to the lozenge, as pointing out the exact place upon the limb at which the required measurement is indicated. If, then, the stroke upon the vernier at the lozenge exactly coincides with a stroke upon the limb, the reading at this stroke gives the measurement required; but, if the stroke at the lozenge be a distance beyond a stroke upon the limb, then will this distance be equal to once, or twice, or thrice, &c., the difference of a division upon the limb and upon the vernier, according as the stroke at the end of the first, or second, or third, &c., division upon the vernier coincides with a stroke upon the limb.

In fig. 1 the stroke upon the vernier at the lozenge falls beyond the stroke indicating 22° upon the limb, and the stroke at the end of the second division upon the vernier coincides with a stroke upon the limb; the reading therefore is $22^\circ 40'$.

In fig. 2, the stroke upon the vernier at the lozenge falls beyond the stroke indicating one inch and three-tenths upon the limb, and the stroke at the end of the sixth division upon the vernier coincides with a stroke upon the limb: the reading, therefore, is 1.36 inches, or one inch three tenths and six hundredths.

The limbs of the best sextants are now divided at every 10 minutes, and 59 of these parts are made equal to 60 divisions of their verniers. In this case

$$L - v = \frac{L}{60} = \frac{10'}{60} = 10'';$$

so that these instruments can be read off by the aid of their verniers to an accuracy of 10 seconds. The verniers occupy on the limbs spaces equal to $9^\circ 50'*$.

* That is, according to the graduation of the instrument; but, as the angles observed by a sextant are double the angles moved over by the index, the limb of the instrument is graduated, as though it were double the size; so that the verniers really occupy an arc of $4^\circ 55'$ only.

The limbs of small theodolites are generally divided at every 30 minutes, and 29 of these parts are made equal to 30 divisions of their verniers, which therefore enables us to read off to an accuracy of $\frac{30'}{30'}$, or 1'.

In the mountain barometer the scale being divided into $\frac{5}{1000}$ ths of an inch, 9 of these parts are made equal to 10 divisions of the vernier, which therefore enables us to read off to an accuracy of $\frac{5}{1000}$ ths of an inch.

In the above explanations we have only considered the case of an exact coincidence between some one of the strokes upon the vernier and a stroke upon the limb. Suppose now that in fig. 1 the stroke at the end of the second division, instead of coinciding with a stroke upon the limb, fell a little beyond it, while the stroke at the end of the third division fell a little short of a stroke upon the limb; then the measurement indicated would be something between $22^\circ 40'$ and 23° , which the observer, should there be no other mechanism attached to the vernier, must estimate by guess, according to the best of his judgment. By the aid, however, of a piece of mechanism, which is called *a micrometer*, and which we proceed to describe, the excess of the angle indicated above $22^\circ 40'$ might be exactly computed.

The instrument having been nearly set by the hand alone, the vernier is fixed in this position by turning a screw, called the clamping screw, which is shown on the top of the vernier in fig. 2, but is not seen in fig. 1, being at the back of the instrument. The instrument is then set more accurately by the screw at the side of the vernier, shown in both figures, which gives a slow motion to the vernier plate, and to the limb or index bar attached to the vernier. This screw is called a tangent or slow motion screw, and the *micrometer*

consists of a graduated cylindrical head, BB, attached to this screw, and an index, I, attached to the vernier.

Suppose, now, the tangent screw to be of that fineness that, whilst it is turned once round, by means of the milled head II, so that the graduated head BB makes one complete revolution, the vernier is advanced on the limb of the instrument, a distance



equal to the difference of a division of the limb, and of the vernier: then, in fig. 1, one revolution of the screw advances the vernier a distance equal to $20'$; and, if the cylindrical head BB be divided into 60 equal parts, a revolution of the screw through one of these parts would advance the vernier a distance equal to $20''$.

Suppose, then, that in the illustration above given the screw has to be turned back, so that 14 of these graduations pass the index I, in order to bring the stroke at the end of the second division upon the vernier into coincidence with a stroke upon the limb; then the corresponding space moved through by the vernier would be equal to $20'' \times 14$, or $4' 40''$, and the reading of the instrument would be $22^\circ 44' 40''$.

Similarly, by means of a micrometer divided into ten equal parts, a distance to the thousandth part of an inch may be read off by the vernier in fig. 2. If the micrometer in this case were divided into one hundred equal parts, a distance might be read off to the ten-thousandth part of an inch; or the same effect may be produced by dividing the micrometer into ten equal parts, and making the screw of such fineness that ten complete revolutions move the vernier through a distance equal to the difference of a division of the limb and of the vernier, or the hundredth part of an inch.

THE BEAM COMPASSES.

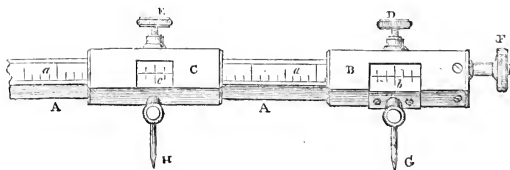

The above engraving represents this instrument, which consists of a beam, AA, of any length required, generally made of well-seasoned mahogany. Upon its face is inlaid throughout its whole length a slip of holly, or boxwood, aa, upon which are engraved the divisions or scale, either feet and decimals, or inches and decimals, or whatever particular scale may be required. Those made for the use of the persons engaged on the Ordnance survey of Ireland were divided to a scale of chains, 80 of which occupied a length equal to six inches, which, therefore, represented one mile, six inches to

the mile being the scale to which that important survey is plotted*. Two brass boxes, B and c, are adapted to the beam; of which the latter may be moved, by sliding, to any part of its length, and fixed in position by tightening the clamp screw E. Connected with the brass boxes are the two points of the instrument, G and H, which may be made to have any extent of opening by sliding the box c along the beam, the other box, B, being firmly fixed at one extremity. The object to be attained, in the use of this instrument, is the nice adjustment of the points G, H, to any definite distance apart. This is accomplished by two vernier† or reading plates, *b, c*, each fixed at the side of an opening in the brass boxes to which they are attached, and affording the means of minutely subdividing the principal divisions, *aa*, on the beam, which appear through those openings. D is a clamp screw for a similar purpose to the screw E, namely, to fix the box B, and prevent motion in the point it carries after adjustment to position. F is a slow motion screw, by which the point G may be moved any very minute quantity for perfecting the setting of the instrument, after it has been otherwise set as nearly as possible by the hand alone.

The method of setting the instrument for use may be understood from the above description of its parts, and also by the following explanation of the method of examining and correcting the adjustment of the vernier, *b*, which, like all other mechanical adjustments, will occasionally get deranged. This verification must be performed by means of a detached scale. Thus, suppose, for example, that our beam compass is divided to feet, inches, and tenths, and subdivided by the vernier to hundredths, &c. First set the zero division of the vernier to the zero of the principal divisions on the beam, by means of the slow motion screw F. This must be done very nicely. Then slide the box c, with its point c, till the zero on the vernier c exactly coincides with any principal division on the beam, as twelve inches, or six inches, &c. To enable us to do this with extreme accuracy some superior kinds of beam compasses have the box c also furnished with a tangent or slow motion screw, by which the setting of the points or divisions may be performed with the utmost precision. Lastly, apply the points to a similar detached scale, and, if the adjustment be perfect, the interval of the points GH will

* The survey of the metropolis is plotted to a scale of 60 inches to the mile.

† For a description of the vernier, see preceding article.

measure on it the distance to which they were set on the beam. If they do not, by ever so small a quantity, the adjustment should be corrected by turning the screw F till the points do exactly measure that quantity on the detached scale; then, by loosening the little screws which hold the vernier b in its place, the position of the vernier may be gradually changed, till its zero coincides with the zero on the beam; and, then tightening the screws again, the adjustment will be complete.

PLOTTING SCALES.

Plotting scales, also called feather-edged scales, are straight rulers, usually about ten or twelve inches long. Each ruler has scales of equal parts, decimally divided, placed upon its edges, which are made sloping, so that the extremities of the strokes marking the divisions lie close to the paper. The primary divisions represent chains, and the subdivisions, consequently, ten links each, as there are 100 links on the surveying chain. Plotting scales may be procured in sets, each with a different number of chains to the inch.

The advantages of this arrangement are, that the distances required can be transferred with great expedition from the scale to the paper by the aid of the pricking-point alone, and the marks denoting the divisions are in no danger of becoming defaced, as upon the plain scale, by the frequent application of the compasses.

One of the best plotting scales consists of two feather-edged rulers, one sliding along the other in a dovetailed groove, so that the two are always at right angles to each other. We shall describe this instrument more particularly when we come to speak of plotting, after describing the instruments used in surveying.

THE PANTAGRAPH.

The pantagraph consists of four rulers, AB , AC , DF , and EF , made of stout brass. The two longer rulers, AB and AC , are connected together by, and have a motion round a center at A . The two shorter rulers are connected in like manner with each other at F , and with the longer rulers at D and E , and, being equal in length to the portions AD and AE of the longer rulers, form with them an accurate parallelogram, $ADFE$, in every position of the instrument. Several ivory castors support the machine parallel to the paper, and allow it to move freely over it in all directions. The arms, AB and

DE, are graduated and marked $\frac{1}{2}$, $\frac{1}{3}$, &c., and have each a sliding index, which can be fixed at any of the divisions by a milled-headed clamping screw, seen in the engraving. The sliding indices have each of them a tube, adapted either to slide on a pin rising from a heavy circular weight called the fulcrum, or to receive a sliding holder with a pencil or pen, or a blunt tracing point, as may be required.

When the instrument is correctly set, the tracing point, pencil, and fulcrum will be in one straight line, as shown by the dotted line in the figure. The motions of the tracing point and pencil are then each compounded of two circular motions, one about the fulcrum, and the other about the joints at the ends of the rulers upon which they are respectively placed. The radii of these motions form sides about equal angles of two similar triangles, of which the straight line B c, passing through the tracing point, pencil, and fulcrum, forms the third sides. The distances passed over by the tracing point and pencil, in consequence of either of these motions, have then the same ratio, and, therefore, the distances passed over in consequence of the combination of the two motions have also the same ratio which is that indicated by the setting of the instrument

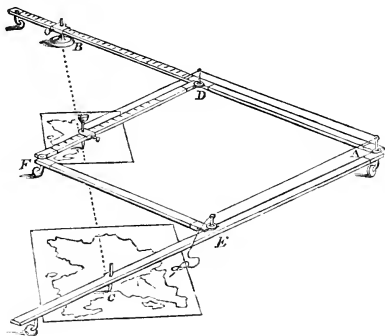

Our engraving represents the pantagraph in the act of reducing a plan to a scale of half the original. For this purpose the sliding indices are first clamped at the divisions upon the arms marked $\frac{1}{2}$; the tracing point is then fixed in a

socket at *c*, over the original drawing; the pencil is next placed in the tube of the sliding index upon the ruler *D F*, over the paper to receive the copy; and the fulcrum is fixed to that at *B*, upon the ruler *A B*. The machine being now ready for use, if the tracing point at *c* be passed delicately and steadily over every line of the plan, a true copy, but of one-half the scale of the original, will be marked by the pencil on the paper beneath it. The fine thread represented as passing from the pencil quite round the instrument to the tracing point at *c*, enables the draughtsman at the tracing point to raise the pencil from the paper, whilst he passes the tracer from one part of the original to another, and thus to prevent false lines from being made on the copy. The pencil holder is surmounted by a cup, into which sand or shot may be put, to press the pencil more heavily on the paper, when found necessary.

If the object were to enlarge the drawing to double its scale, then the tracer must be placed upon the arm *D F*, and the pencil at *c*; and, if a copy were required of the same scale as the original, then, the sliding indices still remaining at the same divisions upon *D F* and *A B*, the fulcrum must take the middle station, and the pencil and tracing point those on the exterior arms, *A B* and *A C*, of the instrument.

The successful use of the pantagraph in copying very minute and complicated drawings can only be attained by perseverance and experience, and we therefore proceed to mention some of the other means employed for the attainment of the same object. In fact, while the pantagraph affords the most rapid means of reducing a drawing, we cannot recommend its use for enlarging a copy, or even for copying upon the same scale.

To produce a Copy of the same Size as the Original. First Method.—Lay the original drawing upon the sheet of paper intended for the copy, and fix them together by means of weights or drawing pins*. 2. With a fine needle† prick through all the angles and principal points, making corresponding punctures in the paper beneath. 3. Draw upon the copy such of the lines on the original as are straight, or nearly so, by joining the points thus marked upon the paper.

* The drawing pin consists of a brass head, with a steel point at right angles to its plane. *A* represents it as seen edgewise, and *B* as seen from above.

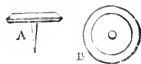

† See pricking point, page 8.

4. Set off such other points upon the copy, by means of the compasses, as may be desirable, and draw the curved lines upon tracing paper placed over the drawing. 5. Fill in the lines indicated by the points set off by the compasses, and transfer the curved lines from the tracing paper to the copy, by rubbing the back of the tracing paper with powdered black lead, placing it in its correct situation upon the copy, and passing a blunt tracing point* over the lines drawn upon it.

Second Method.—A sheet of tracing paper having the under side rubbed over with powdered black lead may be placed upon the paper intended for the copy. The original being then placed over this, the tracing point may be carefully and steadily passed over all the lines of the drawing with a pressure proportioned to the thickness of the paper; and the paper beneath will receive corresponding marks, forming an exact copy, which is afterwards to be inked in.

Third Method.—The drawing is placed upon a large sheet of plate glass called a copying glass, and the paper to receive the copy placed over the drawing. The glass is then fixed in such a position as to have a strong light fall upon it from behind, and shine through it. By this means the original drawing becomes visible through the paper placed over it, and a copy can be made with precision and ease, without any risk of soiling or injuring the original.

To copy with nicety upon a reduced or enlarged Scale.—For this purpose we may have recourse to the method of squares, by which, with the aid of the proportional compasses, the most minute detail may be copied with great accuracy. This may, perhaps, be best shown by an example.

Let figure 1 in the following engraving represent a plan of an estate, which it is required to copy upon a reduced scale of one-half. The copy will therefore be half the length and half the breadth, and, consequently, will occupy but one-fourth of the space of the original. Our subject is a map of an estate, but the process would be precisely the same if it were an architectural, mechanical, or any other drawing.

1. Draw the lines FI and FG at right angles to each other. 2. From the point F towards I and G , set off any number of equal parts, as $F a, a b, b c, \&c.$, on the line FI , and $F i, i k, k l, \&c.$, on the line FG . 3. From the points on the line FI draw lines parallel to the other line FG , as $a a, b b, c c, \&c.$,

* The eye end of the pricking needle, or the fine point of a porcupine's quill, may be used for this purpose.

Fig. 1.

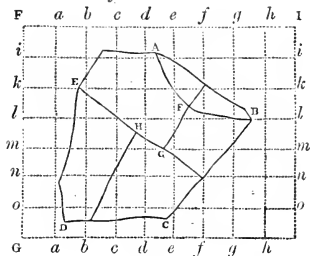
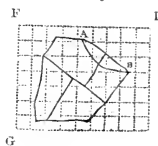

Fig. 2.



and from the points on FG draw lines parallel to FI , as ii , kk , ll , &c., which being sufficiently extended towards G and I , the whole of the original drawing will be covered with a reticule of small but equally-sized squares.

This done, draw upon the paper intended for the copy a similar set of squares, but having each side only one-half the length of the former, as is represented in figure 2. It will now be evident that, if the lines of the plan AB , BC , CD , &c., figure 1, be drawn in the corresponding squares of figure 2, a correct copy of the original will be produced, and of half the original scale. Commencing then at A , observe where, in the original, the angle A falls, which is towards the bottom of the square marked on the top de . In the corresponding square, therefore, of the copy, and in the same proportion towards the left-hand side of it, which should be determined by the use of the proportional compasses, described at page 4, place the same point in the copy. From thence, finding by the proportional compasses the point on the bottom line of that square, where the curved line AF crosses, which is about two-fifths from the left-hand corner towards the right, cross it similarly in the copy. Again, as it crosses the right-hand bottom corner of the second square below de , describe it so in the copy; and by means of the proportional compasses find the points where it crosses the lines ff and gg , above the line ll , by taking the distances of such crossings from the nearest corner of a square in the original, between the large points of the proportional compasses, and with the small points at their opposite end, setting off the required crossing on the corresponding lines on the copy. Lastly, determine the place of the

3



Cotesworth's SLIDING Rule

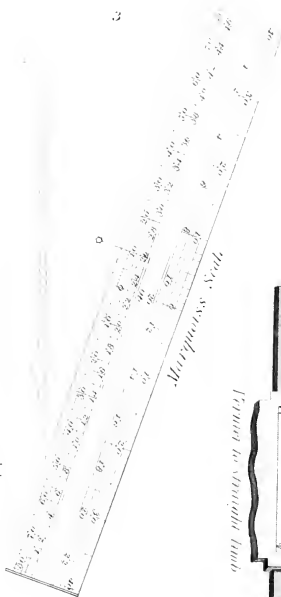

Maryon's Slide



Vernier to attach to 1855



Vernier to straight rule

point B, in the third square below *gh* on the top line; and a line drawn from A in the copy, through these several points to B, will be a correct reduced copy of the original line. Proceed in like manner with every other line on the plan, and its various details, and you will have the plot or drawing, laid down to a small scale, yet bearing all the proportions in itself exactly as the original.

It may appear almost superfluous to remark, that the process of enlarging drawings by means of squares is a similar operation to the above, except that the points are to be determined in the smaller squares of the original, and transferred to the larger squares of the copy. The process of enlarging, under any circumstances, does not, however, admit of the same accuracy as that of reducing.

Having now completed the description of those instruments, applicable to the purposes of geometrical drawing, to the consideration of which we propose for the present to limit ourselves, in accordance with the plan of our little work, we now propose to add thereto a description of *Coggeshall's Sliding Rule*, and then to conclude this part of our subject with some practical hints*, which we think may prove acceptable to the commencing student.

COGGESHALL'S SLIDING RULE.—(Plate II. Fig. 4.)

Coggeshall's, or the Carpenter's Sliding Rule, is the instrument most commonly used for taking the dimensions and finding the contents of timber. It consists of a rule one foot long, having on its face a groove throughout its entire length, in which a second rule of the same length slides smoothly. On the face of the rule are four logarithmic lines marked at one end A, B, C, and D. The three lines A, B, C, are called *double lines*, because the figures from 1 to 10 are contained twice in the length of the rule, and are, in fact, repetitions of the logarithmic line of numbers already described (p. 25). The fourth line, D, is a *single line* numbered from 4 to 40, and is called the *Girt Line*, because the girt dimensions are estimated upon it in computing the contents of trees and timber. The lengths upon this line denote the logarithms of the squares of the numbers, from 4 to 40, placed against the several divisions; and enable us, as will be seen, to obtain approximately the contents of a solid by a single operation.

* Extracted from a treatise on drawing instruments, by F. W. Simms, Civil Engineer and Surveyor.

The line *c* is used with the girt line *D*, and the two lines *A* and *B*, enable us to perform more readily all such operations as have been already described as being performed by the logarithmic line of numbers with the aid of the compasses, the second line *B*, upon the slider, supplying the place of the compasses.

On the girt line is a mark at the point 18·79, lettered *G* (*gallons*), which is the imperial gauge point*, enabling us to compute contents in imperial gallons.

The back of the rule has a decimal scale of one foot divided into one hundred equal parts, by which dimensions are taken in decimals of a foot; and also a scale of inches, numbered from 1 to 12, which scale is continued on the slider and numbered from 12 to 24, so that, when the slider is pulled out, a two feet rule is formed, divided into inches.—The vacant spaces on the rule are filled up with various other scales and tables, which may be selected to suit the purposes of the various purchasers.

The method of notation on the rule, and the manner of estimating any number upon it, are the same as have already been fully explained, when treating of the line of logarithmic numbers (p. 28).

Problem 1. *To multiply two Numbers together.*—Set 1 on *B* to the multiplier on *A*, and against the multiplicand on *B* will be found the required product on *A*. *Example.*—To multiply 33 by 23. Set 1 on *B* to 2·3 on *A*, and against 3·3 on *B* will be found 7·59 on *A*, and 759 is therefore the product required†.

Problem 2. *To divide one Number by another.*—Set 1 on *B* to the divisor on *A*, and against the dividend on *A* will be found the required quotient on *B*. *Example.*—To divide 759 by 23. Set 1 on *B* to 2·3 on *A*, and against 75·9 on *A* will be found 33 on *B*, which is the quotient required.

Problem 3. *To find a Fourth Proportional to three given Numbers.*—Set the first term on *B* to the second term on *A*, and against the third term on *B* will be found the required fourth term on *A*. Or, against the first term on *A*, set the second term on *B*, and against the third term on *A* will be found the required fourth term on *B*. *Example.*—To find a fourth

* 18·79 is the diameter of a cylindrical vessel to contain one gallon for each inch of depth. The gauge point for the old wine gallon was at 17·15, lettered *W. G.*, and for the old ale gallon at 18·95, lettered *A. G.* These marks are consequently found upon rules constructed prior to January, 1826.

† The tens must be supplied mentally, as explained at page 28.

proportional to the three numbers $3\frac{1}{2}$, 11, and 14. Set $3\frac{1}{2}$, or 3·5, on B to 11 on A, and against 14 on B will be found on A, 44, the fourth proportional required.

Problem 4. To find a Third Proportional to two given Numbers.—This is the same problem as the preceding, repeating the second number for the third term of the proportion.

Example.—To find a third proportional to the two numbers $3\frac{1}{2}$ and 11. This is to find a fourth proportional to the three numbers $3\frac{1}{2}$, 11, and 11. Set therefore $3\frac{1}{2}$, or 3·5, on B to 11 on A, and against 11 on B will be found on A 34·6, the third proportional required.

Problem 5. To square a given Number. First Method, by means of the Lines A and B.—Set 1 on B to the given number on A, and against the given number on B will be found its square upon A. *Example.*—Required the square of 23. Set 1 on B to 23 on A, and against 23 on B will be found its square 529 on A.

Second Method, by means of the Lines c and d.—If the number to be squared lie between 1 and 4, or 10 and 40, or 100 and 400, &c., so that its first significant digit is less than 4; set the 1 on c to 10 on d, and against the digits on d, expressing the given number, will be found on c the digits expressing the required square. Then, the square of 1 being 1, of 10, 100, of 100, 10,000, &c., and of ·1 being ·01, of ·01 being ·0001, &c., the digits upon c must be estimated at the actual values represented by them as numbered upon the scale, viz., 1, 2, &c., to 16, or at 100 times their values, from 100 up to 1600, or at 10,000 times their values from 10,000 up to 160,000, &c., or, again, at the $\frac{1}{1000}$ th part of these values from ·01 up to ·16, or at $\frac{1}{10000}$ th part of these values from ·0001, up to ·0016, &c., according as the highest denomination in the number to be squared is units, or tens, or hundreds, &c., or, again, tenths, hundredths, &c. *Example.*—Required the square of 23. The 10 on d being set against the 1 on c, against 23 on d will be found 5·29 on c, and, the highest denominations in 23 being tens, the square required is 529. Also the squares of 2·3, 230, 2300, ·23, ·023, would be 5·29, 52,900, 5,290,000, ·0529, ·000529, respectively, the highest denominations in the proposed numbers being respectively units, hundreds, thousands, tenths, and hundredths. *Third Method, by means of the Lines c and d.*—If the number to be squared lie between 4 and 10, or 40 and 100, or 400 and 1000, &c., so that its first significant digit is not less than 4; set the 100 on c against the 10 on d, and against the digits on d, expressing

the given number, will be found on *c* the digits expressing the required square. *Example.*—Required the square of 51. The 100 on *c* being set against the 10 on *D*, against 5.1 on *D* will be found 26 on *c*, and, the highest denomination in 51 being tens, the square required is 2600*.

Problem 6. *To extract the Square Root of a given Number.*—This problem being the converse of the preceding, set the rule in the same manner, with the 1 on *c* against the 10 on *D*, if the given square be between 1 and 16, or 100 and 1600, or 10,000 and 160,000, &c., or again between .01 and .16, or .0001 and .0016, &c., and with the 100 on *c* against the 10 on *D*, if the given square be between 16 and 100, or 1600 and 10,000 &c., or again between .16 and 1, or .0016 and .01, &c.; and then against the given number on *c* will stand its square root on *D*. *Example 1.*—Required the square root of 529. The given number being between 100 and 1600, set the 1 on *c* against the 10 on *D*, and against 5.29 on *c* will be found 23 on *D*, the square root required. *Example 2.*—Required the square root 2601. The given number being between 1600 and 10,000, set the 100 on *c* against the 10 on *D*, and against 26 on *c* will be found 5.1 on *D*, and 51 is therefore the root sought.

Problem 7. *To find a mean Proportional between two given Numbers.*—Set one of the numbers upon *c* to the same number on *D*, and against the other number on *c* will be found upon *D* the mean proportional required †. *Example.*—Required a mean proportional between 4 and 49. Set 4 on *c* to 4 on *D*, and against 49 on *c* will be found on *D* 14, the mean proportional required.

If one number exceed the other so much that they cannot both be taken off from the line *c*, the $\frac{1}{1000}$ th part of the larger may be taken, and the mean proportional then found, multiplied by 10, will give the mean proportional required. Also if the second number on *c* be situated beyond the scale *D*, the $\frac{1}{1000}$ th part of such second number may be substituted for it, and the result multiplied by 10; or 100 times such number may

* The accurate square is 2601, but the fourth figure cannot be estimated upon a foot rule, and the third figure only approximately. The solution, in fact, may be considered as obtained to within the 200th part of the whole, but, if greater accuracy is required, arithmetical methods must be resorted to.

† If $a : x :: x : b$, then $a : b :: a^2 : x^2$; and, therefore, $\log. b - \log. a = \log. x^2 - \log. a^2$; whence the rule given in the text.

be taken, and the result divided by 10; or, again, such second number may be multiplied or divided by 4, 9, or any square number, and the result divided or multiplied by 2, 3, or the square root of this number; or, again, the numbers may be both multiplied and divided by any the same number, and the result divided or multiplied also by the same number, and, in each case, the required mean proportional will be correctly determined.

Problem 8. *To find the Area of a Board or Plank. First Method.*—Set 12 on B to the mean breadth in inches on A, and against the length in feet on B will be found upon A the required area in feet and decimals of a foot. If the plank taper regularly, the mean breadth is half the sum of the extreme breadths; but, if the plank be irregular, several breadths should be measured at equal distances from each other, and their sum divided by their number may be taken as the mean breadth. In the latter case, however, greater accuracy would be obtained by finding separately the areas of portions of the plank, and adding them together for the whole area, or by the following. *Second Method.*—Take the measure in inches of several breadths at equal distances from each other, and add together half the two extreme breadths, and the sum of all the intermediate breadths. Set 12 on B to the sum thus found upon A, and against the distance in feet, at which the breadths have been measured, upon B will be found upon A the required area in feet and decimals of a foot. *Example 1.*—A board, 15 feet long, being 14 inches broad at one end, and 8 inches broad at the other, required its area. The mean breadth is 11 inches, half the sum of 8 and 14. Set, then, 12 on B against 11 on A, and against 15 on B will be found upon A 13.75 or $13\frac{3}{4}$ feet, the area required. *Example 2.*—An irregular board, 18 feet long, being 7 inches broad at one extremity, 11 inches broad at the other, and the intermediate breadths at each 3 feet of the length being 13 inches, 25 inches, 23 inches, 32 inches, and 22 inches, required its area. By the first method, the sum of the seven breadths divided by 7, gives 19 inches for the mean breadth; and, setting 12 on B against 19 on A, against 18 on B will be found upon A 28.5 or $28\frac{1}{2}$ feet, the area required. By the second method, half of the two extreme breadths added to the intermediate breadths, gives the sum, 123 inches; and setting 12 on B against 123 upon A, against 3 on B will be found upon A $30\frac{3}{4}$, the area required, a more accurate result than the preceding.

Problem 9. *To find the solid Content of squared or four-sided Timber, of the same Size throughout its entire Length. First Method.*—Multiply the breadth by the thickness, and their product again by the length (Problem 1), and the result will be the content required. *Second Method.*—Set the length on c against 12 on d, and against the quarter girt, measured in inches, on d, will be found the approximated content on c in cubic feet: or set the length on c against 10 on d, and against the quarter girt, measured in tenths of feet, on d will be found the approximate content on c. The approximate content thus found is greater than the true content, and the correction to be subtracted to leave the true content is given in the following Table:—

TABLE I.

Fraction of breadth equal to excess of breadth over thickness.	Excess in inches for each 12 inches of breadth.	Fractional portion of approximate content to be subtracted.	Percentage of approximate content to be subtracted.
$\frac{1}{2}$ bre	6	$\frac{1}{9}$ app. cont.	11 per cent.
$\frac{1}{3}$ ”	4	$\frac{1}{25}$ ”	4 ”
$\frac{1}{4}$ ”	3	$\frac{1}{45}$ ”	2 ”
$\frac{1}{5}$ ”	$2\frac{4}{10}$	$\frac{1}{81}$ ”	1 $\frac{1}{4}$ or 1.23 ”
$\frac{1}{6}$ ”	2	$\frac{1}{121}$ ”	or .83 ”
$\frac{1}{7}$ ”	$1\frac{5}{7}$	$\frac{1}{169}$ ”	10 or .59 ”
$\frac{1}{8}$ ”	$1\frac{1}{2}$	$\frac{1}{225}$ ”	17 or .44 ”
$\frac{1}{9}$ ”	$1\frac{1}{3}$	$\frac{1}{289}$ ”	4 or .35 ”
$\frac{1}{10}$ ”	$1\frac{2}{10}$	$\frac{1}{361}$ ”	3 or .28 ”
$\frac{1}{11}$ ”	$1\frac{1}{11}$	$\frac{1}{441}$ ”	5 or .23 ”
$\frac{1}{12}$ ”	1	$\frac{1}{324}$ ”	10 or .19 ”

The fractional portion of the approximate contents in column 3 may be found by dividing the approximate contents by the denomination of the fractions. (Problem 2.)

If the excess of the breadth over the thickness be compared with the quarter girt, the correction has to the approximate content the duplicate ratio of half the excess to the quarter girt, as shown in the following Table:—

TABLE II.

Fraction of quarter girt equal to half the excess of breadth over thickness.	Half the excess of breadth over thickness for each 12 inches of quarter girt.	Correction to be subtracted.	
		Fractional portion of approximate content.	Percentage of approximate content.
$\frac{1}{2}$ qr. girt.	6 inches.	$\frac{1}{4}$ approx. cont.	25 per cent.
$\frac{1}{3}$ "	5 "	$\frac{1}{6}$ nearly or $\frac{25}{144}$ "	$17\frac{1}{3}$ or 17.36 "
$\frac{1}{4}$ "	4 "	$\frac{1}{8}$ "	11 "
$\frac{1}{5}$ "	3 "	$\frac{1}{15}$ "	$6\frac{1}{4}$ or 6.25 "
$\frac{1}{6}$ "	$2\frac{4}{10}$ "	$\frac{1}{25}$ "	4 "
$\frac{1}{7}$ "	2 "	$\frac{1}{35}$ "	$2\frac{7}{9}$ or 2.78 "
$\frac{1}{8}$ "	$1\frac{5}{7}$ "	$\frac{1}{49}$ "	2.04 "
$\frac{1}{9}$ "	$1\frac{2}{3}$ "	$\frac{1}{63}$ "	$1\frac{3}{4}$ or 1.56 "
$\frac{1}{10}$ "	$1\frac{1}{3}$ "	$\frac{1}{81}$ "	$1\frac{1}{4}$ or 1.23 "
$\frac{1}{11}$ "	$1\frac{1}{10}$ "	$\frac{1}{100}$ "	1 "
$\frac{1}{12}$ "	$1\frac{1}{11}$ "	$\frac{1}{121}$ "	$\frac{4}{5}$ or .83 "
$\frac{1}{13}$ "	1 "	$\frac{1}{144}$ "	$\frac{7}{10}$ or .69 "
$\frac{1}{14}$ "	$1\frac{1}{13}$ "	$\frac{1}{169}$ "	$\frac{4}{7}$ or .6 "
$\frac{1}{15}$ "	$\frac{6}{7}$ "	$\frac{1}{195}$ "	$\frac{1}{2}$ or .51 "
$\frac{1}{15}$ "	$\frac{8}{10}$ "	$\frac{1}{322}$ "	$\frac{4}{9}$ or .44 "

The correction may also be found as follows:—Set the length upon c against 12 upon d, and against half the excess of the breadth over the thickness upon d will be found upon c the required correction in cubic feet.

As the error of the result obtained with the rule may amount to the $\frac{1}{200}$ -th part of the whole, the correction given above may always be neglected, whenever the excess of the breadth over the thickness does not exceed the $\frac{1}{8}$ th part of the breadth, or $1\frac{1}{2}$ inch for each 12 inches of breadth, and the result may be depended upon to as great an accuracy as can be obtained by the rule. When, however, the excess is more than two inches for each 12 inches of breadth, either the correction should be applied or the first method be used.

Example 1.—Required the content of a piece of timber 10 inches broad, 8 inches thick, and 18 feet long.

Since $\frac{10}{12} \times \frac{8}{12} = \frac{80}{144}$, set 80 on B against 144 on A, and against 18 on A will be found 10 on B, and the content required is 10 cubic feet. *Example 2.*—Required the content of a piece of timber 15 inches broad, 10 inches thick, and 24

feet long. Set 24 on c against 12 on D, and against 12.5, or $12\frac{1}{2}$, the quarter girt on D, will be found on c 26.04, the approximate content. The excess of 15 over 10 being $\frac{1}{5}$ rd of 15, Table I. shows the required correction to $\frac{1}{5}$ th of 26.04. Set then 25 on B against 26.04 on A, and against 1 on B will be found 1.04 on A, which subtracted from 26.04 cubic feet leaves 25 cubic feet, the true content.

Problem 10. *To find the Content of a Piece of Square Timber, which tapers from end to end.*—Set the length in feet upon c against 12 upon D, and against half the sum in inches of the quarter girts at the two ends upon D will be found a content in cubic feet upon c. Again, set one-third of the length in feet upon c against 12 upon D, and against half the difference, in inches, of the quarter girts at the two ends upon D will be found a second content in cubic feet upon c. Add together the two contents thus found for the content required. If the breadth exceed the thickness considerably, the same part of the result must be subtracted, as in Problem 9.

Example.—The quarter girts at the ends of a piece of timber 21 feet long, being 22 inches and 10 inches respectively, and the breadth not much exceeding the thickness, required the content. Set 21 upon c against 12 on D, and against 16 upon D will be found $37\frac{1}{3}$ or 37.3 upon c. Again, set 7 upon c against 12 upon D, and against 6 upon D will be $1\frac{3}{4}$ or 1.75 upon c. The sum of $37\frac{1}{3}$ cubic feet and $1\frac{3}{4}$ cubic foot is then $39\frac{1}{3}$ or 39.1 cubic feet, the whole content required.

Problem 11. *To find the Content of a Round Piece of Timber of the same Size throughout its entire Length.*—Set the length in feet upon c against 10.63 * upon D, and against the quarter girt in inches upon D will be found the content upon c. *Example.*—Required the content of a round piece of timber 32 feet long, the quarter girt being 11 inches. Set 32 upon c against 10.63 upon D, and against 11 upon D will be found upon c 34.25 or $32\frac{1}{4}$, the content required.

Problem 12. *To find the Content of a Round Piece of Timber, which tapers from end to end.*—Set the length in feet upon c against 10.63 upon D, and against half the sum in inches of the quarter girts at the two ends upon D will be found a content in cubic feet upon c. Again, set one-third of the length in feet upon c against 10.63 upon D, and against half the difference in inches of the quarter girts at the two

* A mark is placed upon the rule at this point, 10.63 being the quarter girt in inches of the circle, whose area is a square foot.

ends upon *D* will be found a second content in cubic feet upon *c*. Add together the two contents thus found for the content required.

Note.—In buying rough or unsquared timber, an allowance of about $\frac{1}{2}$ th should be made for the bark. A further allowance should also be made for the loss in squaring down the tree to make useful shaped timber. The whole amount of timber to be taken off to make a square piece from a round piece of timber will be 36 per cent., or more than a third of the whole. The timber so taken off must not, however, be considered completely valueless. If the length upon *c* be set against 12 upon *D*, instead of upon 10.63 in the two preceding problems, this will be equivalent to an allowance of about $21\frac{1}{2}$ per cent., which may be considered a just allowance.

Example 1.—A piece of round tapering timber measures 23 feet in length, the quarter girt at the larger end is $23\frac{1}{2}$ inches, and at the smaller end the quarter girt is $15\frac{1}{2}$ inches. Required the true content. Set 23 upon *c* against 10.63 upon *D*, and against $19\frac{1}{2}$ or 19.5 upon *D* will be found 77.5 upon *c*. Again, set $7\frac{2}{3}$ or 7.66 upon *c* against 10.63 upon *D*, and against 8 upon *D* will be found 4.3 upon *c*. Then the sum of 77.5 cubic feet and 4.3 cubic feet is 81.8 cubic feet, the content required. *Example 2.*—Required the content of a piece of unsquared timber of the same dimensions as in the preceding example, making allowance of $21\frac{1}{2}$ per cent. for loss in squaring down into a useful shape. Set 23 upon *c* against 12 upon *D*, and against $19\frac{1}{2}$, or 19.5, upon *D* will be found 60.75 upon *c*. Again, set $7\frac{2}{3}$ or 7.66 upon *c* against 12 upon *D*, and against 8 upon *D* will be found 3.4 upon *c*. Then the sum of 60.75 cubic feet and 3.4 cubic feet is 64.15 cubic feet, the content required.

Problem 13. To find the Content of a Cylindrical Vessel in Gallons.—Set the length of the cylinder in inches upon *c* against the gauge mark at 18.79, marked *G*, upon *D*, and against the diameter of the cylinder in inches upon *D* will be found the required content in gallons upon *c*. If the number of inches in the diameter lie beyond *c*, or if this number be greater than 40, so as not to be contained upon *D*, the $\frac{1}{10}$ th part, or any part that may be convenient, of the number of inches in the diameter may be taken, and the result thus obtained, multiplied by 100, or the square of the divisor made use of, will give the content required. *Example.*—A circular vat 5 feet in diameter being filled to the depth of four feet, required the quantity of liquor in it. Set 48 upon *c* against the gauge mark at 18.79 upon *D*, and against 6, the $\frac{1}{10}$ th part of the diameter in inches, upon *D* will be found upon *c* 4.9; and consequently 4.9×100 or 490 gallons is the quantity of liquor in the vat.

PRACTICAL HINTS, ETC.*

ON THE MANAGEMENT OF DRAWING PAPER.

THE first thing to be done, preparatory to the commencement of a drawing, is to stretch the paper evenly upon the smooth and flat surface of a drawing board. The edges of the paper should first be cut straight, and, as nearly as possible, at right angles with each other; also the sheet should be so much larger than the intended drawing and its margin, as to admit of being afterwards cut from the board, leaving the border by which it is attached thereto by glue or paste, as we shall next explain.

The paper must first be thoroughly and equally damped with a sponge and clean water, on the opposite side from that on which the drawing is to be made. When the paper absorbs the water, which may be seen by the wetted side becoming dim, as its surface is viewed slantwise against the light, it is to be laid on the drawing board with the wetted side downwards, and placed so that its edges may be nearly parallel with those of the board; otherwise, in using a T square, an inconvenience may be experienced. This done, lay a straight flat ruler on the paper, with its edge parallel to, and about half an inch from, one of its edges. The ruler must now be held firm, while the said projecting half inch of paper is turned up along its edge; then, a piece of solid glue (common glue will answer the purpose), having its edge partially dissolved by holding it in boiling water for a few seconds, must be passed once or twice along the turned edge of the paper, after which, this glued border must be again laid flat by sliding the rule over it, and, the ruler being pressed down upon it, the edge of the paper will adhere to the board. If sufficient glue has been applied, the ruler may be removed directly, and the edge finally rubbed down by an ivory book-knife, or any clean polished substance at hand, which will then firmly cement the paper to the board. Another but *adjoining* edge of the paper must, next, be acted upon in like manner, and then the remaining edges in succession; we say the *adjoining* edges, because we have occasionally observed that, when the opposite and parallel edges have been laid down first, without continuing the process progressively round the board, a greater degree of care is required to prevent undulations in the paper as it dries.

* Extracted from a Treatise on Drawing Instruments by F. W. Simms, Civil Engineer and Surveyor.

Sometimes strong paste is used instead of glue; but, as this takes a longer time to set, it is usual to wet the paper also on the upper surface to within an inch of the paste mark, care being taken not to rub or injure the surface in the process. The wetting of the paper in either case is for the purpose of expanding it; and the edges being fixed to the board in its enlarged state, act as stretchers upon the paper, while it contracts in drying, which it should be allowed to do gradually. All creases or undulations by this means disappear from the surface, and it forms a smooth plane to receive the drawing.

TABLE OF DIMENSIONS OF DRAWING PAPER.

Demy . . .	20 in.	by 15 $\frac{1}{4}$ in.	Columbier . .	35 in.	by 23 $\frac{1}{2}$ in.
Medium . . .	22 $\frac{3}{4}$ "	17 $\frac{1}{2}$ "	Atlas	34 "	26 "
Royal . . .	24 "	19 $\frac{1}{4}$ "	Double Elephant	40 "	27 "
Super Royal .	27 $\frac{1}{4}$ "	19 $\frac{1}{4}$ "	Antiquarian .	53 "	31 "
Imperial . .	30 "	22 "	Emperor . .	63 "	48 "
Elephant . .	28 "	23 "			

MOUNTING PAPER AND DRAWINGS, VARNISHING, ETC.

In mounting paper upon canvas, the latter should be well stretched upon a smooth flat surface, being damped for that purpose, and its edges glued down as was recommended in stretching drawing paper. Then with a brush spread strong paste upon the canvas, beating it in till the grain of the canvas be all filled up; for this, when dry, will prevent the canvas from shrinking when subsequently removed; and, having cut the edges of the paper straight, paste one side of every sheet, and lay them upon the canvas, sheet by sheet, overlapping each other a small quantity. If the drawing paper is strong, it is best to let every sheet lie five or six minutes after the paste is put on it; for, as the paste soaks in, the paper will stretch, and may be better spread smooth upon the canvas; whereas, if it be laid on before the paste has moistened the paper, it will stretch afterwards and rise in blisters when laid upon the canvas. The paper should not be cut off from its extended position till thoroughly dry; and the drying should not be hastened, but gradually take place in a dry room, if time permit; if not, the paper may be exposed to the sun, unless in the winter season, when the help of a fire is necessary, care being had that it is not placed too near a scorching heat.

In joining two sheets of paper together by overlapping, it

is necessary, in order to make a neat joint, to feather edge each sheet; this is done by carefully cutting with a knife half way through the paper near the edges, and on the sides, which are to overlap each other; then strip off a feather-edged slip from each, which, being done dexterously, the edges will form a very neat and efficient joint when put together.

The following method of mounting and varnishing drawings or prints was communicated some years ago by Mr. Peacock, an artist of Dublin. Stretch a piece of linen on a frame, to which give a coat of isinglass or common size. Paste the back of the drawing, leave it to soak, and then lay it on the linen. When dry, give it at least four coats of well-made isinglass size, allowing it to dry between each coat. Take Canada balsam diluted with the best oil of turpentine, and with a clean brush give it a full flowing coat

GENERAL RULES APPLICABLE IN ALL GEOMETRICAL CONSTRUCTIONS.

In selecting black-lead pencils for use, it may be remarked that they ought not to be very soft, nor so hard that their traces cannot be easily erased by the India rubber. Great care should be taken, in the pencilling, that an accurate outline be drawn; the pencil marks should be distinct yet not heavy, and the use of the rubber should be avoided as much as possible, for its frequent application ruffles the surface of the paper, and will destroy the good effect of shading or colouring, if any is afterwards to be applied.

The following seven useful rules are taken from Mr. Thomas Bradley's valuable work on Practical Geometry:—

“1. Arcs of circles, or right lines by which an important point is to be found, should never intersect each other very obliquely, or at an angle of less than 15 or 20 degrees; and, if this cannot be avoided, some other proceeding should be had recourse to, to define the point more precisely.

“2. When one arc of a circle is described, and a point in it is to be determined by the intersection of another arc, this latter need not be drawn at all, but only the point marked off on the first, as it is always desirable to avoid the drawing of unnecessary lines. The same observation applies to a point to be determined on one straight line by the intersection of another.

“3. Whenever the compasses can be used in any part of a construction, or to construct the whole problem, they are to be preferred to the rule, unless the process is much more circuitous, or unless the first rule (above) forbids.

“4. A right line should never be obtained by the prolongation of a very short one, unless some point in that prolongation is first found by some other means, especially in any essential part of a problem.

“5. The larger the scale on which any problem, or any part of one, is constructed, the less liable is the result to error; hence all angles should be set off on the largest circles which circumstances will admit of being described,

and the largest radius should be taken to describe the arcs by which a point is to be found through which a right line is to be drawn; and the greater attention is to be paid to this rule, in proportion as that step of the problem under consideration is conducive to the correctness of the final result.

“ 6. All lines, perpendicular or parallel to another, should be drawn long enough at once, to obviate the necessity of producing them.

“ 7. Whenever a line is required to be drawn to a point, in order to insure the coincidence of them, it is better to commence the line from the point; and if the line is to pass through two points, before drawing it the pencil should be moved along the rule, so as to ascertain whether the line will, when drawn, pass through them both. Thus, if several radii to a circle were required to pass through any number of points respectively, the lines should be begun from the center of the circle; any error being more obvious when several lines meet in a point.

PART II.—ON OPTICAL INSTRUMENTS.

UNDER this head our principal object will be to consider the construction, and principles of action, of such instruments as are indispensable to assist the vision in making observations upon distant objects, whether upon terrestrial objects for the purposes of the surveyor, or upon celestial objects for the purposes of astronomy and navigation. We propose, however, to add a few words upon such other optical instruments, as by their utility, or by the frequency with which they are brought before us, appear to demand our attention.

We shall thus be led, in the first place, to review briefly the properties of prisms, lenses, and plane and curvilinear reflectors, and shall then proceed to give descriptions of the following instruments, viz.,

Microscopes.	} Such as are adapted to surveying and astronomical instruments, rather fully.
Telescopes.	
The Camera Lucida.	} Very briefly.
The Camera Obscura.	

THE PRISM.

A collection of straight lines, either conical or cylindrical, representing rays of light, is called a pencil of light, and the axis of the cylinder or cone is called the axis of the pencil.

The term medium is used in optics to signify any transparent substance, that is, any substance into which a portion of the light falling upon it can pass.

The term prism in optics is used to signify a portion of any medium bounded by plane surfaces which are inclined to one another. The bounding surfaces are called the faces of

the prism; the line in which the faces intersect is called the edge of the prism; and the angle at which the faces are inclined is called the refracting angle.

The prism is to be placed so that the axis of the pencil, by which an object is seen through it, be in a plane perpendicular to the edge of the prism; and the axis of the pencil during and after its passage through the prism still remains in this plane.

One effect of a prism of denser material than the surrounding medium is to bend every ray of light passing through it, and, consequently, the whole pencil, further from the edge of the prism.

Another effect of such a prism is to decompose each single ray of white light into several rays of different colours, which rays are bent at different angles, so as to form a lengthened image of different colours, of the point from which the ray proceeds. This image is called the spectrum, and these colours the colours of the spectrum.

When, then, any object is viewed through a prism, the two following effects are produced.

1stly. The apparent position of the object is changed, so that, if the prism be held with its edge

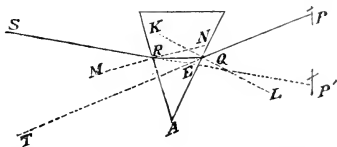

downwards, as in the accompanying figure, the object appears lower than it really is, while, if the prism were held with its edge upwards, the object would appear in a position higher than its actual position. 2ndly. The boundaries of the object are indistinctly defined, and fringed with colours.

Our figure represents the section of the prism made by the plane of incidence, that is, by the plane which is perpendicular to the edge of the prism, and contains the incident ray of light PQ , forming the axis of the pencil under consideration, which proceeds from one point of an object P . AQ and AK are sections of the faces of the prism; A is a point in its edge; and the angle QAR is its refracting angle. Now the ray of light, PQ , proceeding from the object at P through the medium of the atmosphere, is bent, upon entering the denser medium of the prism, from the direction QT into the direction QR , nearer to LQK , the perpendicular, at the point of incidence Q , to the face AQ of the prism; and, upon emerging

from the prism into the rarer medium of the atmosphere, is again bent from the direction QR into the direction RS , further from MEN , the perpendicular to the face AR at the point of emergence R . The eye, being placed at s , sees the point P , therefore, by means of a pencil of light of which SR is the axis, and P consequently appears at P' on the prolongation of the line SR . A similar effect being produced upon every other point, the entire object is apparently depressed, as represented in the figure.

The angle TES , or PEP' , between ERS , the direction of emergence, and PET , the direction of incidence, is called the angle of deviation*.

The consideration of the properties of the prism is of great importance, as exhibiting in the simplest manner the principles of the refraction and dispersion of light. The prism is also used in optical instruments, to change the direction of the pencils of light by which an object is observed, in order to make the apparent place of this object, as viewed through the prism, coincide with the actual place of other objects seen directly, as in the prismatic compass †, or for the mere purpose of convenient observation, as in the Newtonian telescope †.

* The amount of refraction when a ray of light passes from one medium into another varies with the angle of incidence, so that the sine of the angle of refraction bears a constant ratio to the sine of the angle of incidence. This ratio varies for each different medium, and is called the refracting power of the medium. The deviation of a ray in passing through a prism varies also with the angle of incidence, and has a minimum value when the angles of incidence and emergence are equal: and the refracting power can be determined by finding practically this minimum deviation, as follows:—Place the prism with its edge downwards, so as to receive a small beam of solar light, admitted into a dark room through a hole in a shutter, and let the beam of light, after refraction, be received upon a screen behind the prism. The prism must then be turned round an axis parallel to its edge, so as to vary the angle of incidence, and, consequently, the position of the bright spot upon the screen; and, in one particular position, we shall find the bright spot to remain stationary for an instant, though the motion of the prism is continued. The deviation will then be a minimum, and will be equal to the sum of the sun's altitude and the inclination of the emergent beam to the horizon. Let s represent this minimum deviation, and A the refracting angle of the prism, and let the

refracting power be represented by μ : then $\mu = \frac{\sin. \frac{A + s}{2}}{\sin. \frac{A}{2}}$

† These instruments will be described hereafter.

LENSES.

A portion of any medium bounded by two spherical surfaces having a common axis, or by a spherical surface and a plane one, is called a lens.

The effects produced by lenses upon pencils of light depend both upon the form of the lens itself, and upon the direction in which the pencil is proceeding with respect to the lens. Lenses consequently receive distinguishing names, to mark either different forms, or different positions with respect to the light falling upon them. These distinguishing names are the following, and the forms and positions of the corresponding lenses are represented in the accompanying diagram, the light being considered to be proceeding from left to right.



- | | | |
|----------------------|--------------------|----------------------|
| 1. Convex meniscus. | 3. Double convex. | 5. Plano-convex. |
| 2. Concave meniscus. | 4. Double concave. | 6. Convexo-plane. |
| | 7. Plano-concave. | 9. Concavo-convex. |
| | 8. Concavo-plane. | 10. Convexo-concave. |

The rays forming any pencil of light must either be divergent, parallel, or convergent; and when a pencil of light passes through an essentially convex lens, that is, one which is thicker in the middle than at the edges, as 1, 2, 3, 5, 6, the rays are made more convergent, so that a pencil of converging rays becomes still more convergent, a pencil of parallel rays becomes convergent, and a pencil of diverging rays becomes either less divergent, parallel, or convergent: but when a pencil of light passes through an essentially concave lens, that is, one which is thinner in the middle than at the edges, as 4, 7, 8, 9, 10, the rays are made more divergent, so that a pencil of converging rays becomes either less convergent, parallel, or divergent, a pencil of parallel rays becomes divergent, and a pencil of diverging rays becomes still more divergent.

The sensation of vision is produced by pencils of rays proceeding from every point of the visible object, and entering

the pupil of the eye; and in order to produce distinct vision the rays of each such pencil must either be parallel or slightly divergent. Thus the sun, moon, and planets are seen distinctly, although so distant, by parallel rays; and the least distance from the eye at which an object can be seen distinctly varies in different persons, according to the power of the natural lenses which, in fact, form the eye. 1. When any object is brought nearer to the eye than this without the intervention of a lens, the vision becomes confused. If, however, the rays of light proceeding from the object were, by the interposition of a convex lens, rendered less divergent or parallel, the vision would be again distinct. 2. It is further necessary for distinct vision that the intensity of the light be not less than a certain intensity, as may easily be exemplified by gradually closing the shutters of a room, and thus diminishing the intensity of the light proceeding from the objects in the room, when they will grow more and more indistinct. 3. Lastly, it is also necessary, for distinct vision of any object, that the axes of the pencils proceeding from its extreme parts enter the eye under an angle not less than a certain angle, so that, however strong a light be thrown upon an object, if this object be very minute, or removed to a distance very great with respect to its magnitude, it will not be seen by the naked eye. If, however, by the assistance of a lens, or combination of lenses, a sufficient number of rays to produce the required intensity of light can be collected from each point of an object, and passed through the pupil of the eye, and if at the same time the axes of the extreme pencils are bent by this lens, or combination of lenses, so as to enter the eye under a sufficiently large angle, while the rays of each pencil are made parallel, or but slightly divergent, then vision will ensue, no matter how minute, how distant, or how imperfectly illuminated the object may be.

When a pencil of rays proceeding from a point of an object passes through a lens, the rays which pass through at different distances from its center will diverge from or converge to different points, so that the whole pencil will not any longer diverge from or converge to a single point; and from this cause the image of one point will overlap the image of another, and an indistinctness of the object will arise. This source of indistinctness is called the *aberration*. A combination of lenses may, however, be formed, so that the aberration of one shall be corrected by the aberration of the others. Such a combination is said to be *aplanatic*.

Since rays of light proceed in every direction from the points of visible objects, the pencils of light intercepted by a lens for the first time are all central, that is, their axes all pass through the center of the lens; but the pencils, upon emerging from this first lens, are already determinate both in extent and direction, and consequently will fall, some of them at least, eccentrically upon a second lens, that is, their axes will meet this lens at different distances from its center. The axes of the most eccentric pencils will then, after emergence, cross the axis of vision nearer to the lens than will those of the more nearly central pencils; and thus, while the center of the object is seen distinctly, the parts at a distance from the center will be distorted, or *vice versa*. This source of error is called the *spherical confusion*. The spherical confusion is diminished by dividing the desired deviations, or bendings of the axes, between two or more lenses; and it is found by opticians to be a good rule to divide the deviations equally amongst the lenses employed.

The most important source of indistinctness, however, is the dispersion of each ray into rays of different colours refracted at different angles (p. 68). which is called the *chromatic dispersion*. The effect of this dispersion upon a central pencil is partly analogous to the spherical aberration, causing the images of neighbouring points to be of finite extent and overlap one another; and it, moreover, fringes the image with colour. An eccentric pencil is separated by this dispersion into pencils of rays of different colours, the axes of which are bent at different angles; and the imperfection arising from this cause is far greater than that from both the spherical aberration and spherical confusion.

Before stating the manner in which the imperfections arising from the chromatic dispersion are remedied, it will be expedient to explain what is understood by the focal length of a lens. Now a pencil of parallel rays, after passing through a lens, becomes either convergent or divergent, as the lens is convex or concave, and the distance from the point to which the pencil converges, or from which it diverges, to the surface of the lens, is called the focal length of the lens.

To find practically the Focal Length of a Convex Lens.—Place a lighted candle at one extremity of a scale of inches and parts, with which the lens has been connected in such a manner as to slide along, and always have its axis parallel to the scale. A flat piece of card is also to be made to slide along, so as to be always in a line with the light and the lens,

the lens being between the light and the card. The lens and card are then to be moved along, backwards and forwards, till the least distance between the card and light is discovered at which a clear image of the light is formed upon the card : and this distance is four times the focal length.

The imperfection arising from the chromatic dispersion is remedied, for the central pencil, by making a compound lens of two or more lenses of different substances, as flint glass and crown glass, which are fitted close together, and are of such focal lengths that the chromatic dispersion of one is counteracted by the chromatic dispersion of the other. The effect of the chromatic dispersion upon an eccentric pencil is remedied by setting two or more lenses at proper distances depending upon their focal lengths. Such a combination of lenses is called an achromatic eye-piece.

When an object is placed at a distance from a convex lens greater than its focal length, the divergent pencils of rays, proceeding from every point of the object, become, after passing through the lens, convergent, and at a certain distance from the lens *, having converged nearly to points again, form there an inverted image of the object. The essential difference between any point in this image, and the corresponding point in the object itself, is, that the latter emits light in all directions, while the light from the former is limited to the pencil which has been transmitted through the lens, and is consequently determinate both in magnitude and direction. If, however, a screen be placed at the required * distance from the lens, a picture of the object in an inverted position will be formed upon this screen, and from each point of this picture light will be emitted in all directions in the same manner as from the points of the object itself. The single pencil of light from any point of the object, transmitted through the lens, supplies, however, in this case, the light for all the pencils emitted from the corresponding point of the image ; and a very strong light must therefore be thrown upon the object to give a moderate brightness to the picture ; more especially if the picture be of larger dimensions than the

* If u be the distance from the lens at which the object is placed, f the focal length of the lens, then v , the distance from the lens at which the image is formed, is determined from the equation $\frac{1}{v} = \frac{1}{f} - \frac{1}{u}$. The linear magnitude of the image is to that of the object as v to u .

object A portion of the light is also absorbed by the lens itself

REFLECTORS.

When a ray of light is reflected at a plane surface, the reflection takes place in a plane perpendicular to the reflecting surface, and the incident and reflected rays make equal angles with this surface. Thus, if QA represent a ray of light incident upon a plane reflector at the point A , and the plane of the paper represent the plane which contains QA , and is perpendicular to the reflecting surface, intersecting it in the line RAR' , then making the angle $Q'AR'$ in the plane QAR' equal to the angle QAR , AQ' will represent the course of the reflected ray.



The effect of a plane reflector upon the pencils of light which fall upon it is to change the direction of all the rays forming each pencil without altering the angles at which the several rays of the pencil are inclined to one another, so that the divergency or convergency of the pencils remains the same after reflection as before, and the objects from which they proceed appear to be at the same distances behind the mirror as they really are in front of it.

Thus, a pencil of light diverging from a point of an object at P , after reflection at the point R of a plane mirror, appears to proceed from the point P' on the line PMP' , perpendicular to the mirror, at the distance MP' behind the mirror, equal to the distance MP . The point P' , from which, after reflection, the pencil appears to have diverged, is called a virtual focus; and the apparent image of the object behind the mirror is called a virtual image.

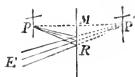

The uses of a single plane reflector in mathematical instruments are nearly the same as the uses of a prism: viz., either to alter the apparent position of an object, so as to make its visual image coincide with the real image of some other object, as in the prismatic compass (described hereafter), or merely to change the direction of the pencils for the purposes of more convenient observation, as in the Newtonian telescope, (see page 84), the diagonal eye-piece (see page 83), &c.

When a ray of light, proceeding in a plane at right angles to each of two plane mirrors, which are inclined to each other at any angle whatever, is successively reflected at the plane sur-

faces of each of the mirrors, the total deviation of the ray is double the angle of inclination of the mirrors. For let ii and Hh represent sections of the two mirrors made by the plane of incidence at right angles to each of them, and let sI represent the course of the incident ray: then the ray sI is reflected at I into the direction Ih , making with ii the angle hIA , equal to the angle sIi , and is again reflected at II into the direction IE , making, with Hh , the angle EHA equal to the angle IhH . Now the angle AHV , being equal to the exterior angle IhH , is equal to the two angles hIA and hAI ; and because the vertical angles AVH and IVE are equal, and that the three angles of every triangle are equal to two right angles, therefore the two angles VEI and SEH are, together, equal to the two angles AHV and hAI , and therefore to the angle hIA and twice the angle hAI (since AHV has been proved equal to hIA and hAI); but VEI , being equal to the vertical angle sIi , is equal to the angle hIA : therefore, taking away these equals, the remainder, the angle SEH , is equal to the remainder, twice the angle hAI . *Q.E.D.*

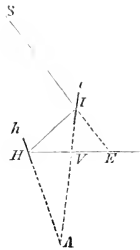

This property of two plane reflectors enables us by their aid to measure the angle subtended at the eye by any two objects whatever, and is the foundation of the construction of Hadley's Quadrant, and the improvements upon it: viz., Hadley's Sextant, and Troughton's Reflecting Circle, hereafter to be described.

Note.—Plane reflectors are usually made of glass silvered at the back; and, as reflection takes place at each surface of the glass, there is formed a secondary image, which must not be mistaken for the primary and distinct image intended to be observed.

ON CURVILINEAR REFLECTORS.

Spherical reflectors, or specula, as they are called, produce upon pencils of rays results precisely similar, with one exception, to those produced by lenses. Thus, a *concave reflector* makes the rays of the pencils incident upon it more convergent, and corresponds in its uses with a convex lens; while a *convex reflector* makes the rays of the incident pencils more divergent after reflection, and corresponds in its uses with a

concave lens. The exception to the similarity of the results produced by lenses and reflectors is, that with the latter there is no chromatic dispersion, and the only sources of error are the aberration and spherical confusion, which are common to both spherical reflectors and lenses. For astronomical observations, however, in which case the rays incident upon the object-speculum are parallel, these sources of error are removed by making this speculum of a parabolic form, and another speculum, if it be used, of the form of the vertex of a prolate spheroid. There is great difficulty in procuring flint glass in pieces of large size without flaws, and we are consequently limited as to the size of the lenses of good quality that can be formed with such glass; and, without its use, we have not hitherto been able to form available achromatic object-glasses. Recourse is, therefore, had to parabolic or spherical specula in the formation of telescopes of large power for examining the heavens*. These specula are formed of metal, and the chief objection to them is the impossibility of producing an accurate surface. Even supposing its general form to be correct, there are always minute inequalities arising from the nature of the substance, which cause a waste or dispersion of light. Great pains are, consequently, taken in their construction to obtain the form and surface of the best possible quality†.

MICROSCOPES.

The microscope is an instrument for magnifying minute, but accessible objects. A convex lens is a microscope, but the imperfections of such an instrument have been already explained (p. 71), and the greater the power of the lens the

* Sir William Herschel's largest telescope was 40 feet long, and the mirror 4 feet wide. Lord Rosse's largest telescope is 56 feet long, and the mirror 6 feet wide.

† The following description of the methods employed in forming and polishing parabolic reflectors is extracted in an abridged form from an account of Skerryvore Lighthouse, by Alan Stevenson, LL.B. F.R.S.E. M.I.C.E., Engineer of the Northern Light Board.

"The reflector plate is formed of virgin silver and the purest copper, from the ingot, in the proportion of 6 oz. silver to 16 oz. of copper. The two metals are formed into pieces of the form of rectangular parallelepipeds about 3 inches in length, and the same in breadth, and are then tied together with wire, placed in the furnace, and united with a flux of burnt borax and nitre, mixed to the consistence of cream. The metal thus united is repeatedly passed through the rolling mill, and annealed in the furnace after each time of passing through, until it comes out a plate 28 inches square. It is then cut into a circular disc ready for hammering; and great care must

greater will be these imperfections. For small magnifying powers, then, convex lenses may be used, as they are for spec-

be taken to keep the metal clean during the processes of hammering and polishing now to be performed.

“The hammering is commenced by placing the plate with the copper side upon a block slightly concave, and beating it on the inner or silver side with a box-wood mallet, rounded at each end, *c* and *d* (fig. 1). The beating

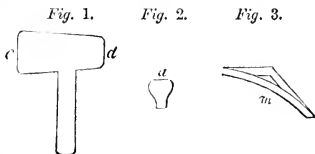

is commenced on the edge and continued round and round till the center is gradually reached. After the disc has been raised sufficiently by this means, it is taken to a machine called the horse, and beaten with a wooden mallet upon the copper side, its concave face being turned about upon a bright steel head *a* (fig. 2), until it has nearly reached the proper height for the reflector, which is ascertained by a mould *m* (fig. 3).

“After each course of raising with the wooden mallet the reflector is annealed, as follows: first damped with clean water, and dusted over with powder, composed of one pint of powdered charcoal to one ounce of saltpetre; then put on a clear charcoal fire, till the powder flies off and shows when it is duly heated. It is next plunged into a pickle, composed of one quart of vitriol in five or six gallons of water; and, lastly, washed with clean water and scoured with Calais sand.

“The next step is to put the reflector into an iron stool, and, having drilled a small hole in its vertex, to describe a circle from this point with beam compasses, and cut the paraboloid to the proposed size.

“The reflector is now *hard-hammered* with a planishing hammer, or planished, as it is called, on the bright steel head *a*; and then *smoothed* with a lighter hammer muffled with parchment. Then comes the finishing, called also, filling up to the mould, which is thus performed. It is constantly tried with the mould *m*, and those portions which do not meet it are marked with fine slate pencil, and then gone over with the muffled hammer, till every point touches the mould. Great care must be taken in this process that no part of the surface be raised above the gauge, or the reflector would have to be re-formed with the wooden mallet, and the whole process repeated. The reflector is then tried with a lamp brought to its focus, and, if the whole surface is luminous, it is fit for polishing; but, if not, it must be again tested by the mould, and carefully filled up with the muffled hammer, till the result of the lamp test is perfectly satisfactory.

“The edge of the reflector is next turned over to stiffen it, and the bizzle *w* (fig. 1), and back belt *g* (fig. 2), having been soldered on, the final process of polishing may be proceeded with. This process is commenced by scouring, first with a piece of pure charcoal of hard wood, and next with a mixture of Florence oil and finely-washed rotten stone, applied by means of a large ball of superfine cloth. The reflector is then cleansed with a fine flannel dipped in Florence oil, and afterwards dusted over with powder of well-washed whiting, and wiped out with a soft cotton cloth. Lastly, it is carefully rubbed by the naked hand with finely-washed rouge and

tacles; but for obtaining good images with high magnifying powers a combination of lenses must be used.

Small glass spheres are used as microscopes of high powers; but a thin lens composed of any more highly refractive substance is preferable; because, the focal length of the sphere measured from its center being but three semi-radii, the distance of the object from the surface is only one semi-radius, which prevents its being used in the examination of delicate objects. The refracting sphere is much improved as a microscope by cutting a groove round it in a diametrical plane, and filling it up with some black opaque substance. By this contrivance the aperture is diminished, without contracting the field of view, and all the pencils are necessarily central.

Microscopes have been made of diamond and sapphire, and the aberration is much less than with glass. Dr. Brewster

clean water, and wiped with a smooth chamois skin. In all the polishing and cleansing processes some skill is required in the manipulation, as the hand must be moved in successive circles parallel to the lips of the reflector, and having their centers on the axis of the generating curve."

Fig. 1.



Fig. 2.

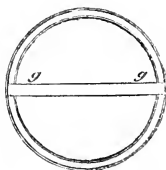

The speculum of Lord Rosse's great telescope is composed of 1261 parts of copper and 589 of tin, fused together and cast in a mould, the bottom of which is formed of hoop iron bound closely together with the edges uppermost. By this means the heat is conducted away through the bottom so as to cool the metal towards the top, while the interstices between the hoops, though small enough to prevent the metal from running out, are sufficiently open to allow the air to escape. After casting, the speculum is annealed in a brick oven, which is heated almost to a red heat, and shut up with the speculum in it, and allowed to cool gradually. The speculum is then placed with its face upwards upon a turning apparatus, and the grinding and polishing performed entirely by the aid of mechanical contrivances, so that the proper parabolic form is accurately given to it. To test the work, the dial-plate of a watch is placed upon the top of a mast at 90 feet distance from the speculum, and the image of this dial-plate formed by the speculum, being viewed through an eye-glass properly placed the distinctness of this image denotes the accuracy of the speculum.

employed, as a microscope, a drop of Canada balsam or turpentine varnish upon a thin plate of glass, of which the surfaces were exactly parallel. This is a very ready way of forming a plano-convex lens, and if kept free from dust will last some time.

The compound or achromatic microscope consists of four lenses and a diaphragm, placed in the following order: the object-lens; the diaphragm; the amplifying lens, so called because it amplifies or enlarges the field of view; the field-lens; and the eye-lens. The relations between the focal lengths and intervals of the lenses, and the distance of the diaphragm from the object-lens, are determined, so that the combination may be achromatic, aplanatic, and free from spherical confusion. The field-lens and eye-lens form what is called the eye-piece; and the object-lens and amplifying lens form, or tend to form, an enlarged image of the object, in the focus of the eye-piece, which image is viewed through the eye-piece. When the focus of the eye-piece is beyond the field-lens, so that the image is formed between the amplifying lens and the field-lens, the eye-piece is called a *positive eye-piece*; but when the focus of the eye-piece is between the two lenses of which it is composed, in which case its effect corresponds with that of a concave lens, it is called a *negative eye-piece*. With a negative eye-piece the pencils proceeding from the amplifying lens are intercepted by the field-lens before forming an image, and the image is formed between the field-lens and the eye-lens, in the focus of the latter.

The best microscopes are constructed with compound object-lenses, which are both achromatic and aplanatic; and by this means the aperture, and consequently the quantity of light, is much increased. Good compound lenses possessing the required properties have been formed of a concave lens of flint glass, placed between two convex lenses, one of crown glass, and the other of Dutch plate.

The magnifying power of any refracting microscope or telescope may be practically found, by pointing the object-end of the instruments towards the light, and receiving the image of the object-glass formed by the other lenses upon a screen placed at the eye-end of the instrument, and at a proper distance from it, which may be determined by trial. Then the ratio of the diameter of the object-glass, or of the diaphragm, in the case of the compound microscope, to the diameter of its image upon the screen, gives the magnifying power of the telescope or microscope. In all microscopes it is necessary

to illuminate the object strongly, in consequence both of the diffusion of the small portion of light, received from the object, over the magnified image, and of the absorption of the light by the several lenses.

The Reflecting Microscope.—In this instrument a concave speculum of short focal length is substituted for the object-lens. The object is placed on one side of the axis of the instrument, so that its perpendicular distance from the axis, together with the distance from the speculum of the point where this perpendicular meets the axis, may be a little greater than the focal length of the speculum. A small plane reflector is placed upon the axis of the instrument at the point where the perpendicular from the object meets it. This reflector is set at an angle of 45° to the axis, and having its plane perpendicular to the plane through the object and the axis. The object being strongly illuminated, the pencils of rays proceeding from it, after reflection at the plane reflector and concave speculum, tend to form a magnified image, but are intercepted by the field-glass of the negative achromatic eye-piece, called the Huyghenian eye-piece (p. 82); and the image formed after the transmission of the rays through the field-glass is viewed through the eye-glass.

In the examination of small objects with a high power, it is necessary that the microscope should be perfectly free from all tremor, the slightest motion being so magnified as to prevent a good view from being obtained. Regard must be had, therefore, to solidity and accuracy in the fitting of all the joints and screws: in the choice of an instrument, and for a first-rate instrument, recourse should be had only to a maker of well-known talent, as many so-called opticians are mere sellers of articles of the qualities of which they are totally ignorant. The adjustment of the eye-piece should be obtained through the medium of a clamp and slow motion screw of the best kind*, in which the screw acts upon a spiral spring, and by means of which the adjustment for a good focus may be obtained with the greatest possible accuracy, and without the slightest tremor. If the workmanship and fittings of the instrument appear to be satisfactory, a few test objects should be examined with it, to try the quality of the combination of lenses. Two of the best test objects are the Podura plombea, or Skiptail, a small wingless insect, the size of a flea, found in damp cellars, and the Navicula Sigma, a small

* The best clamp, referred to in the text, is Dollond's, or a modification of Dollond's clamp.

shell found in fresh water pools. The surface of the scales of the *Podura plumbea* should appear covered with a great number of delicate marks, like notes of admiration. The *Navicula Sigma* should appear completely chequered with a number of longitudinal and transverse lines. Should the instrument show these test objects well, it may at once be deemed a good one.

TELESCOPES.

The *Refracting Telescope* consists of a convex object-glass, which forms an image of a distant object, and an eye-piece of one or more lenses, which performs the office of a microscope for viewing this image. The most simple form of the telescope is that called the *astronomical telescope*, and consists of

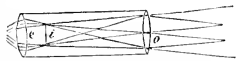

two convex lenses, the object-glass *o*, of as great focal length, and, consequently, low magnifying power, as the size of the telescope will permit, and the eye-glass *e*, of small focal length, and, consequently, high magnifying power. When arranged for distinct vision of a distant object, the distance between the two lenses is equal to the sum of their focal lengths: an inverted image, *i*, of the object is, consequently, formed in the common focus of the two lenses, and the pencils proceeding from the image consist, after refraction at the eye-glass, of parallel rays, which are the most favourable for distinct vision.

The magnifying power of this instrument is represented by the ratio of the focal length of the object-glass to that of the eye-glass, and may therefore be increased either by increasing the focal length of the object-glass, or by diminishing that of the eye-glass. The latter means, however, cannot be resorted to without increasing both the chromatic dispersion and the spherical aberration. Hence, before the means were discovered of forming achromatic and aplanatic object-glasses, the only unobjectionable way of increasing the power of the telescope was by increasing the focal length of the object-glass, and astronomers used to attach the object-glass to the end of a long pole. This contrivance was called an *aërial telescope*. Huyghens used one of 123 feet in length, and Cassini one of 150 feet:

That the field of view should be as bright as possible, the image of the object-glass formed by the eye-glass at the place of the eye should not be larger than the pupil of the eye; and

the brightness will then vary directly as the square of the diameter of the object-glass, and inversely as the square of the magnifying power. The brightness is also diminished by passing through the refracting media; and hence it is always an object to employ as few lenses as possible, consistently with the attainment of the other requisites of a good telescope.

Refracting telescopes for astronomical observations are now constructed with achromatic object-glasses, and eye-pieces of two lenses, called celestial eye-pieces, which are of one or the other of the two following constructions :

1. *The Huyghenian Eye-piece* consists of two convexo-plane lenses, with their plane sides, consequently, turned towards the eye, their focal lengths and the interval between them being as 3, 1, and 2. The lens of greatest focal length, f , is

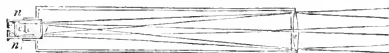

next the object-glass, and is called the field-lens, because it enlarges the field of view. When the telescope is arranged for distinct vision of a distant object, the field-lens is placed between the object-glass and its focus, at a distance from the latter equal to half its own focal length. The pencils of rays from the object-glass, tending to form an image at a distance from the field-lens equal to three-fourths of the interval between the two lenses of the eye-piece, are intercepted by the field-lens and brought sooner to a focus so as to form the image i , half way between the two lenses, and consequently in the focus of the eye-lens e . In this eye-piece the refractions of the axes of the pencils are equally divided between the two lenses, by which the spherical confusion is much diminished; the forms of the lenses are also such as to diminish the spherical aberration, and the relation between the focal lengths of the lenses and the interval between them is such as to satisfy the conditions of achromatism. This eye-piece, called a *negative eye-piece* (p. 79), is always to be preferred, when we are only seeking to obtain the best defined and most distinct view of an object, and is the best eye-piece for all reflecting telescopes; but when it is necessary to place cross-wires or spider-lines at the place of the image in the field of view, for the purpose of accurately measuring the position of an object, at the time of observation, or to apply an apparatus, called a micrometer, for measuring the dimensions

of an image, the Huyghenian eye-piece can no longer be employed.

We have then recourse to *Ramsden's Eye-piece*, called a *Positive Eye-piece* (p. 79). This consists of two lenses of equal



focal lengths, one plano-convex, and the other convexo-plane, so that the convex sides are turned towards one another, the interval between them being equal to two-thirds of the focal length of either. When the telescope is arranged for distinct vision of a distant object, the field-lens f , is placed at a distance from the object-glass o , greater than the focal length of this glass by one-fourth of its own focal length. The focus of the object-glass is then also the focus of the entire eye-piece, and the rays proceeding from the image at i , emerge from the eye-lens e , parallel, or in the condition best adapted for distinct vision. This eye-piece is not achromatic, but the spherical aberration is less with it than with the Huyghenian eye-piece. Whether the eye-piece be positive or negative, a diaphragm is placed at the place of the image so as to intercept all the extraneous light.

With the eye-pieces of which we have been speaking, the object appears inverted, which is no inconvenience when this object is one of the heavenly bodies. These eye-pieces are consequently called celestial eye-pieces. For the convenient observation of stars near the zenith, a plane reflector or prism is placed in the eye-piece, by which the directions of the pencils are turned, so that the axis of the eye-lens is at right angles to the axis of the instrument. Such an eye-piece is called a *diagonal eye-piece*.

When terrestrial objects are to be viewed, it is generally necessary that they should appear erect, for which purpose the inverted image formed by the object-glass must be again inverted by the eye-piece. The terrestrial, or erect eye-piece, used for this purpose, is coincident with the compound microscope already described (p. 79), consisting of an object-lens, a diaphragm, amplifying lens, field-lens, and eye-lens, the two latter forming either a negative or positive eye-piece. In consequence of the loss of light consequent upon this construction, portable telescopes with celestial eye-pieces are used by navigators for descrying objects at night, and these telescopes are, consequently, called night-glasses.

By substituting for the convex eye-lens of the astronomical telescope a concave eye-lens of the same focal length, a simple telescope is formed with only two lenses, which shows objects erect. This is called the Galilean telescope, and is the construction used for opera glasses. When arranged for distinct vision of a distant object, the object-glass and eye-lens are separated by a distance equal to their focal lengths. The pencils of light proceeding from the object, after refraction at the object-glass o , tend to form an image of the object in the common focus of the two lenses; but, being intercepted by the concave eye-lens e , their rays are rendered parallel, and, consequently, adapted to produce distinct vision to an eye placed behind this lens.

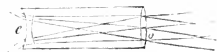

The magnifying power, as in the astronomical telescope, is represented by the ratio of the focal length of the object-glass to that of the eye-lens.

Reflecting Telescopes.—Since the discovery of the methods of forming achromatic and aplanatic object-glasses, the magnitude and available magnifying powers of refracting telescopes are theoretically unlimited; but the difficulty of procuring flint glass of even texture and free from flaws, in pieces of any considerable magnitude, has hitherto practically placed a limit upon the magnitude and available power of refracting telescopes. By the substitution, however, of reflectors, which are always achromatic, for the object-glasses, telescopes of colossal magnitude have been most successfully constructed. Of reflecting telescopes there are four kinds—the Newtonian, the Gregorian, the Cassegrainian, and the Herschelian.

The Newtonian telescope consists of a concave object-speculum, s , a plane reflector m , making an angle of 45° with the axis of the

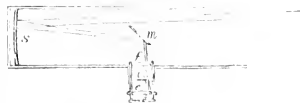

telescope, placed between the object-speculum and its focus, and an eye-piece. The pencils of light proceeding from a distant object tend to form an image after reflection at the object-speculum, but are bent by the plane reflector, so that the image is formed at i , on the axis of the eye-piece, and in the focus of the eye-lens.

The Gregorian telescope consists of a concave object-speculum, s , a small concave speculum, r , whose focal length is

short compared with that of the object - speculum, and an eye-piece. The



small speculum is placed so that its focus is near the focus of the object-speculum, but a little further from this speculum. The pencils of light proceeding from a distant object, after reflection at the object-speculum, form an inverted image, *h*, of the object at the focus of this speculum, and after reflection again at the small speculum form a second image, *i*, inverted with respect to the former, and, consequently, erect with respect to the object.

This telescope has, for terrestrial purposes, the advantage over the Newtonian telescope, of showing objects erect, but yields to it both in the brightness and perfection of the image, because the second mirror increases the spherical aberration produced by the first, and it is extremely difficult to give the mirrors the proper curvature to remedy this evil.

The Cassegrainian telescope consists of two specula and an eye-piece, like the Gregorian, but the second speculum is convex instead of concave, and is placed between the object-speculum and its principal focus, at a distance from this focus somewhat less than its own focal length. The pencils of light proceeding from a distant object, after reflection at the object-speculum, tend to form an inverted image of the object, but are intercepted, before doing so, by the convex speculum, and made to form the image still inverted, in the focus of the eyepiece. Objects, therefore, are still inverted; but the spherical aberration of the convex speculum being opposite to that of the concave object-speculum, the whole spherical aberration is diminished. This telescope is also shorter than the Gregorian. It is, however, inferior to the Newtonian telescope for celestial observations, and not well adapted for terrestrial purposes on account of the inversion of the object.

When light is reflected at a mirror or speculum, there will always be a waste and dispersion; and in consequence of the two reflections, and also of the light intercepted by the plane mirror, or second speculum, the loss of light in all the reflecting telescopes hitherto described is considerable. Sir W. Herschel, by a very simple contrivance, obtained what is called the front view; but this construction is only applicable to instruments of very large dimensions. In the Herschelian telescope the axis of the object-speculum, *s*, is slightly inclined to

the axis of the tube, and the image *i*, being thus thrown to one side of the tube, is there viewed by the eye-piece.



We shall now proceed to explain the best methods of adjusting and testing telescopes, as given by Pearson in his valuable work on Practical Astronomy.

Methods of Adjusting and Testing Refracting Telescopes.—Let us suppose that we have a refracting telescope of $3\frac{1}{2}$ feet focal length, and $3\frac{1}{4}$ inches aperture. Then, to test the object-glass, lay the tube of the telescope in a horizontal position upon some fixed support about the height of the eye, and place a printed card vertically, but for a celestial eye-piece in an inverted position, against some wall or pillar at thirty or forty yards' distance, so as to be exposed to a clear sky; then, when the telescope is directed to this object, and adjusted by the sliding tube for distinct vision, the letters on the card should appear clearly and sharply defined, without any colouration or mistiness; and, if very small points appear well defined, the object-glass may be deemed a pretty good one for viewing terrestrial objects. If the glass be intended for astronomical observations, fix at the same distance a black board, or one-half of a sheet of black paper, and a circular disc of white paper, about a quarter of an inch or less in diameter, upon the center of the black ground; then having directed the telescope to this object, and adjusted for distinct vision, mark with a black-lead pencil the sliding eye-tube, at the end of the main tube, so that this position can always be known; and if this sliding tube be gradually drawn out, or pushed in, while the eye beholds the disc, it will gradually enlarge and lose its colour, till its edges cease to be well defined. Now, if the enlarged misty circle is observed to be concentric with the disc itself, the object-glass is properly centered, as it has reference to the tube; but, if the misty circle goes to one side of the disc, the cell of the object-glass is not at right angles to the tube, and must have its screws removed, and its holes elongated by a rat-tailed file, small enough to enter the holes. When this has been done, replace the cell, and examine the disc a second time, and a slight stroke on the edge of the cell by a wooden mallet will show, by the alteration made in the position of the misty portion of the disc, how the adjustment is to be effected, which is known to be right when a motion in the sliding tube will make the disc enlarge in a circle concentric with the disc itself. When, then, the disc will enlarge so as to make a ring of diluted white light round its circumference, as the sliding tube holding the eye-piece is pushed in, or drawn out, the cell may be finally fixed by the screws passing through its elongated holes. When the object-glass is thus adjusted, we can proceed to ascertain whether the curves of the respective lenses composing the object-glass are well formed and suitable for each other.

If a small motion of the sliding tube of about one-tenth of an inch from the point of distinct vision, in a $3\frac{1}{2}$ -feet telescope, will dilute the light of the disc and render the appearance confused, the figure of the object-glass is good; particularly if the same effect will take place at equal distances from the point of good vision, when the tube is alternately drawn out and pushed in. Such an object-glass is said to be aplanatic. A telescope that will admit of much motion in the sliding tube without affecting sensibly the distinctness of vision will not define an object well at any point of adjustment, and must be considered as having an imperfect object-glass in which the spherical aberration is not duly corrected. The achromatism of the object-glass is to be judged of by the absence of colouration round the enlarged disc. When an object-glass is free from imperfection both in respect of its aplanatism and achromatism, it may be considered a good glass for all terrestrial purposes.

How far an object-glass is good for astronomical observations can only be determined by actual observation of a heavenly body. When a good telescope is directed to the Moon, or to Jupiter, the achromatism may be judged of by alternately pushing in, and drawing out, the eye-piece, from the place of distinct vision; in the former case a ring of purple will be formed round the edge; and, in the latter, a ring of light green, which is the central colour of the prismatic spectrum; for these appearances show that the extreme colours, red and violet, are corrected. Again, if one part of a lens employed have a different refractive power from another part of it, that is, if the glass, particularly flint glass, be more dense in one part than another, a star of the first, or even of the second magnitude will point out the natural defect by the exhibition of an irradiation, or what opticians call a wing at one side, which no perfection of figure or adjustment will banish; and, the greater the aperture, the more liable is the evil to happen.

Another method of determining both the figure and quality of the object-glass is by first covering its center by a circular piece of paper, as much as one-half of its diameter, and adjusting it for distinct vision of a given object, which may be the disc above mentioned, when the central rays are intercepted, and then trying if the focal length remains unaltered, when the paper is taken away, and an aperture of the same size applied, so that the extreme rays may in their turn be cut off. If the vision remains equally distinct in both cases, without any new adjustment for focal distance, the figure is good, and the spherical aberration cured; and it may be seen, by viewing a star of the first magnitude successively in both cases, whether the irradiation is produced more by the extreme, or by the central parts of the glass; or, in case one-half of the glass be faulty and the other good, a semicircular aperture, by being turned gradually round in trial, will detect what semicircle contains the defective portion of the glass; and, if such portion should be covered, the only inconvenience that would ensue would be the loss of so much light as is thus excluded.

The smaller a large star appears in any telescope, the better is the figure of the object-glass; but, if the image of the star be free from wings, the size of its disc is not an objection in practical observations, as it may be bisected by the small line by which the measure is to be taken. When, however, an object-glass produces radiations in a large star, it is unfit for the nicer purposes of astronomy. In testing a telescope, if a glass globe be placed at 40 yards distance when the sun is shining, the speck of light reflected from this globe forms a good substitute for a large star, as an object to be viewed.

Whenever an object-glass is under examination, it will be proper to have the object examined by it in the center of the field of view; and, when an object-glass is tested for astronomical purposes by the methods described

above, it is necessary to employ a good negative eye-piece, which generally gives a better field of view than the positive.

If any fringes of red or yellow are observed on the edges of a white disc placed on a black ground, when the telescope is adjusted for distinct vision, and the disc carried too near the edges of the field, this species of colouration indicates that the *eye-piece* is not sufficiently free from spherical aberrations; and, if the curves of the lenses are suitable for each other, the cure is effected by an alteration in the distance between them, which must be finally adjusted by trial with a good object-glass.

Methods of Adjusting and Testing Reflecting Telescopes.—To adjust the specula of a Cassegrainian or Gregorian instrument procure a Ramsden's eye-piece, which will render an object visible in the compound focus of the two lenses of which it is composed; then hold this eye-piece in front of the Huyghenian eye-piece of the telescope, and, by varying the distance, find the position in which the image of the large speculum is seen, well defined through both eye-pieces, and, if the image of the small speculum is seen precisely on the center of the large one, the metals may be considered as rightly placed; but, if not, the proper screws must be used in succession, till the required position is determined. When the face of the large metal stands at right angles to the length of the tube, the adjustment may generally be finished without disturbing it; and, when the bed that receives it has once been properly finished, it will be advisable not to alter it, unless some accident should render such alteration indispensable.

To try whether the figures of the metals are adapted for each other.—Let the instrument be directed to some luminous point, as a white disc on a black ground, or, what is better, to a star: then having adjusted for distinct vision, firstly observe if the disc or star is well defined, and free from irradiations; secondly, carrying the small speculum short distances beyond, and short of, the place for distinct vision, examine if the disc or star enlarges alike in similar changes of position: if the result be satisfactory, the metals may be considered as well placed, and well adapted for each other.

To try whether the large speculum partake of the parabolic form, let the aperture be partially covered, first at the central part, and then round the circumference by tin, pasteboard, or stiff paper; and if on trial the same adjustment for distinct vision be good in both these cases, and also when the speculum is all exposed, the figure may be considered good. If these effects be not produced, the instrument will be incompetent to perform several of the nicer observations in astronomy. When a mistiness appears in the field, it is a proof that the aberrations are not corrected, and that the figure of at least one of the specula is not perfect.

If a telescope is not good with its full aperture, its effect may be greatly improved, by putting a cover on the mouth, with a circular aperture, of about one-half the diameter that the tube has, in such a way that the diminished aperture may fall entirely at one side of the opening of the tube.

THE SOLAR MICROSCOPE.

In this instrument the object itself is not viewed through a combination of lenses, as in the microscopes already described (pp. 76–81), but a magnified image of the object is formed by a combination of lenses, and received upon a screen. The term solar is applied to the instrument, because the light of the sun, concentrated by a lens, is made use of to illuminate

the object to be observed, and the construction is in all other respects identical with the common magic lantern, and the oxy-hydrogen microscope. In the case of the microscope, however, whether illuminated by the sun or the brilliant oxy-hydrogen light, great regard must be had to the forms of the lenses and the perfection of the setting; while a comparatively very rough instrument forms a very amusing toy as a magic lantern, exhibiting grotesque figures and scenes, which are painted in transparent colours upon glass slides.

The arrangement of the apparatus will be understood from the annexed diagram; r is a reflector for turning the sun's



rays in a direction parallel to the axis of the instrument: c is the lens for concentrating these rays upon the object placed at o , a little further from the first lens, p , of the magnifier, than the focal length of this magnifier, which is one-fourth the focal length of p ; then we have p and m , the two lenses forming the magnifier, which are of equal focal length, and separated by an interval equal to two-thirds of the common focal length, as in Ramsden's positive eye-piece: lastly comes the diaphragm, d , placed at a distance from m , the second lens of the magnifier, equal to the focal length of this magnifier, which is one-fourth the focal length of m or p .

The best forms of the two lenses are, for the first, a plano-convex, and, for the second, a convex meniscus, the radii of whose surfaces are as 1 to 15; and the advantage aimed at in this construction is to render the image flat, and consequently capable of coinciding with the plane screen upon which it is to be received. A similar purpose is the object of the construction of Ramsden's eye-piece, viz., to obtain, as it is there called, a flat field.

The object being placed a little further from p than the focal length of the magnifier, the pencils of rays from each point of the object, after passing through the two lenses, become slightly convergent, and, at a distance from the diaphragm depending upon the distance of the object from the lens p , the magnified image is formed inverted with respect to the object.

THE CAMERA OBSCURA.

This instrument consists of a plane reflector, upon which

pencils of light from the various points of a landscape are received and reflected, so as to pass first through a diaphragm, and then through a plano-convex lens, after which the rays of the pencils become convergent, and form an image upon a screen in a darkened chamber placed to receive it. The diaphragm and lens are placed in a tube, which is passed through a hole in the chamber just large enough to receive it, so that no extraneous light may be admitted. The distance of the lens from the diaphragm is determined upon the condition that the image shall be distinct. The form of the screen also, that the image may be distinct, is a paraboloid of revolution, or figure formed by the revolution round its axis of a parabola, whose radius of curvature at the vertex is μf , μ being the refracting power of the medium of which the lens is formed, and f the focal length of the lens. A curved surface of this form is, therefore, made of plaster of Paris, and placed at a distance from the lens rather greater than the focal length, the exact distance depending upon the nearness or remoteness of the landscape to be depicted, and being easily found by trial. If the camera be set up in the neighbourhood of a well-frequented thoroughfare, we have then an agreeable succession of distinct and vividly-coloured pictures, differing from finely-executed paintings only by exhibiting the actual motions of the objects viewed, men walking, horses trotting, soldiers marching, banners streaming, and foliage shaking in the breeze.

THE CAMERA LUCIDA.

This ingenious instrument, the invention of Dr. Wollaston, consists of a quadrilateral prism, of which $A B C D$ represents a section made by a plane at right angles to each of its edges, mounted upon an axle parallel to its edges. This axle is attached to the end of a rod sliding in a tube, which has at the other end a clamp for fixing it to the edge of a table, so that the distance of the prism from the table can be shortened or lengthened at pleasure. $A B$ is equal to $B C$, and $A D$ to $D C$, and the angles of the prism are a right angle at B , an angle of 135° at D , and angles each $67' 30''$ at A and C . Over the face $B A$, and projecting beyond A , is a plate of metal having in it a narrow longitudinal aperture, which is just bisected by the edge A of the prism.

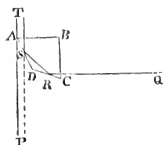

The axis QR , of a small pencil of light from an object Q , directly in front of the face BC , passes straight through this face, and falls upon the face DC , making with it an angle of $22^\circ 30'$. It is there reflected* into the direction RS , and falling upon the face DA , at the same angle, is again reflected into the direction ST , perpendicular to the face AB , and consequently passes straight through this face without refraction. Looking down through the aperture in the metal plate, an image of the object Q is seen at P , at a distance from AB equal to the distance of the object itself from BC ; and if AB be placed, by means of the sliding rod before mentioned, at a distance from the table equal to the distance of the object from the prism, and a sheet of paper be laid upon the table at P , the apparent place of the object, as seen through the prism, will coincide with the actual place of the paper, seen through the projecting part of the aperture, and an accurate drawing of the object may be traced upon the paper. If the object Q be distant, its image may be brought nearer, and thus made to coincide with the place of the paper, by placing a concave lens before the face BC of the prism.

PART III.—SURVEYING INSTRUMENTS.

SURVEYING instruments may be divided into three classes: 1. Instruments for measuring distances. 2. Instruments for measuring angles. 3. Instruments for laying down the survey upon paper, or, as it is called, plotting the survey.

Under the first of these classes we propose to describe—

1. The chain.
2. The spirit level and levelling staves.

* When a ray of light passes from a denser into a rarer medium it is refracted farther from the perpendicular to the refracting surface, so that, if ϕ be the angle which the ray in the denser medium makes with the perpendicular to this surface, and ϕ' the angle which the ray in the rarer medium, after refraction, makes with the same perpendicular, $\mu \sin. \phi = \sin. \phi'$, the refracting power μ being greater than unity. If, then, the angle ϕ be increased, the angle ϕ' is also increased, and becomes a right angle, when ϕ becomes equal to the angle whose sine is equal $\frac{1}{\mu}$. The ray then is refracted directly along the surface, and neither emerges, nor is reflected; but, if ϕ be still farther increased, the ray of light is reflected back into the denser medium, according to the ordinary law of reflection. With ordinary crown glass, for which $\mu = \frac{3}{2}$, this takes place when ϕ exceeds $41^\circ 49'$, or the ray makes with the surface an angle less than $48^\circ 11'$.

Under the second we shall include—

- | | |
|---------------------------|------------------------|
| 1. The prismatic compass. | 3. The optical square. |
| 2. The box sextant. | 4. The theodolite. |

And under the third, in addition to the instruments already described in Part I. of this Work, we shall say something of—

1. The large circular protractor.
2. The T square and semicircular protractor.
3. The best form of plotting scale.
4. The station pointer.

THE LAND CHAIN.

Gunter's chain is the instrument used almost universally for measuring the distances required in a survey. For extensive and important surveys, however, such as those carried on under the Board of Ordnance, a base of about 5 or 6 miles in length is first measured by some more accurate instrument, and all the principal lines, and the distances of the extreme points, are calculated from triangles connecting them with this base. An instrument which has been known to answer well for this purpose is a steel chain 100 feet long, constructed by Ramsden, jointed like a watch chain. This chain is always stretched to the same tension, supported on troughs laid horizontally, and allowances are made for changes in its length made by temperature, at the rate of $\cdot 0075$ of an inch for each degree of heat from 62° of Fahrenheit.

To return, however, to Gunter's chain;—it is 66 feet, or four poles in length, and is divided into 100 links, which are joined together by rings. The length of each link, together with the rings connecting it with the next, is consequently $\frac{66 \times 12}{100}$ inches, or 7.92 inches. To every tenth link are attached pieces of brass of different shapes for more readily counting the links in distances less than a chain.

The following tables exhibit the number of chains and links in the different units of lineal measure, and the number of square chains and links in the different units of square measure, made use of in this country:—

A TABLE OF LINEAR MEASURES.

Links.	Feet.	Yards.	Poles.	Chains.	Furlongs.	Mile
25	$16\frac{1}{2}$	$5\frac{1}{2}$	1	1		
100	66	22	4	1		
1,000	660	220	40	10	1	
8,000	5,280	1,760	320	80	8	1

A TABLE OF SQUARE MEASURES.

Sq. Links.	Sq. Feet.	Sq. Yards.	Sq. Pole, or Perch.	Sq. Ch.	Roods.	Acres.	Sq. Mile.
625	272 $\frac{1}{4}$	30 $\frac{1}{4}$	1	1			
10,000	4,356	484	16	1			
25,000	10,890	1,210	40	2 $\frac{1}{2}$	1		
100,000	43,560	4,840	160	10	4	1	
64,000,000	2,787,400	3,097,600	102,400	6,400	2,560	640	1

As, then, an acre contains 100,000 square links, if the content of a survey, cast up in square links, be divided by 100,000, the quotient gives at once the content in acres, and decimals of an acre. But the division by 100,000 is performed by merely pointing off the five last figures towards the right hand for the decimals of an acre, and the remaining figures towards the left hand are the acres in the content required.

The decimals thus pointed off being then multiplied by 4, and the five last figures pointed off as before, the remaining figures are the roods; and the five decimals cut off from this product, multiplied by 40, give the poles, or perches, and decimals of a pole, the same number, 5, of digits being again pointed off, including the zero, which arises from the multiplication by 40. Thus, if the side of a square field measured 11 chains, 75 links, or 1175 links, the area of the field would contain 1175×1175 , or 1,380,625 square links, which is equivalent to 13·80625 acres. Then ·80625 acres is equivalent to $\cdot 80625 \times 4$, or 3·22500 roods; and, again, ·22500 roods is equivalent to $\cdot 22500 \times 40$, or 9·00000 poles. The field consequently would measure 13 acres, 3 roods, 9 poles.

Ten arrows must be provided with the chain, about 12 inches long, pointed at one end, so as to be easily pressed into the ground, and turned at the other end, so as to form a ring to serve for a handle.

In using the chain marks are first to be set up at the extremities of the line to be measured. Two persons are then required to perform the measurement. The chain leader starts with the ten arrows in his left hand, and one end of the chain in his right, while the follower remains at the starting point, and, looking at the mark, or staff, at the other extremity of the line to be measured, directs the leader to extend the

chain in the direction of this mark. The leader then puts down one of his arrows, and proceeds a second chain's length towards the end of the line, while the follower comes up to the arrow first put down. A second arrow being now put down by the leader, the first is taken up by the follower, and the same operation is repeated till the leader has expended all his arrows. Ten chains, or 1000 links, have now been measured, and, this measurement having been noted in the field book, the follower returns the ten arrows to the leader, and the same operations are repeated. When the leader arrives at the end of the line, the number of arrows in the follower's hand shows the number of chains measured since the last exchange of arrows, noted in the field book, and the number of links extending from the last arrow to the mark, or staff, at the end of the line being also added, gives the entire measurement of the line. Thus, if the arrows

9000
400
-63
9463

have been exchanged 9 times, and if the follower have 4 arrows, and from the arrow last laid down to the end of the line measure 63 links, the whole measurement will be 9463 links.

To assist in preserving the line straight, as well as to serve for a check upon the number of chains measured, it is a good method to set up a staff at each ten chains, when the arrows are exchanged.

In using the chain care must be taken to stretch it always with the same tension, and, as it will give when much used, it must occasionally be examined, and shortened if necessary.

When the ground over which the measurement is taken rises or falls, or both alternately, the horizontal distances are what we require for plotting the survey, and not the actual distances measured along the line of the ground.

For many ordinary purposes the horizontal measurement may be obtained by holding one end of the chain up, so as to keep it, as nearly as can be judged, horizontal, the arrow being placed vertically under the end so held up; but, when a more accurate survey is required, the distances must be measured along the line of ground, and, the angles of elevation and depression of the several inclined parts of the line being afterwards taken with the theodolite, or the vertical risings and fallings being taken by the process of levelling with the spirit level and staves, the correct horizontal distances must thence be computed. The following table shows the number of links to be subtracted from every chain, or 100 links, for the angles there set down, being in fact the versed sines of those angles

to a radius of 100. The correction for each 100 links, for any angle whatever, may at once be taken from a table of natural versed sines, by considering the first two figures as integers. The correction may also be taken from a table of natural cosines, by subtracting each of the first four figures from 9, and reckoning the first two figures as integers, and the last two as decimals: thus, to find the correction for an inclination of $8^{\circ} 19'$, take the first four figures of the cosine of $8^{\circ} 19'$, which will be 9894, and, subtracting each of these four figures from 9, we obtain 0105: then, considering the first two figures of this result as integers, and the last two as decimals, we have 1.05 for the correction due to the inclination $8^{\circ} 19'$ for every 100 links. If the last figure in the correction thus found be increased by 1, whenever the fifth figure of the cosine is less than 5, the result will be more accurate.

TABLE showing the Reduction in Links and Decimals of a Link upon 100 Links for every half Degree of Inclination from 3° to $20^{\circ} 30'$.

Angle.	Reduction.	Angle.	Reduction.	Angle.	Reduction.
$3^{\circ} 0'$	0.15	$9^{\circ} 0'$	1.23	$15^{\circ} 0'$	3.41
30	0.19	30	1.37	30	3.64
4 0	0.24	10 0	1.53	16 0	3.87
30	0.31	30	1.67	30	4.12
5 0	0.38	11 0	1.84	17 0	4.37
30	0.46	30	2.01	30	4.63
6 0	0.55	12 0	2.19	18 0	4.89
30	0.64	30	2.37	30	5.17
7 0	0.75	13 0	2.56	19 0	5.45
30	0.86	30	2.76	30	5.74
8 0	0.97	14 0	2.97	20 0	6.03
30	1.10	30	3.19	30	6.33

The advantage of Gunter's chain is its adaptation to the superficial measure of land in acres, &c.; but, when a survey is to be made for the purpose of linear measurements only, or when it may be more convenient to compute the area in square feet, a chain 100 feet long, divided into links of a foot long, is to be preferred. Such a chain is best adapted to military surveying.

Offsets, perpendicular to the main line, to hedges and remarkable objects on either side of it, are measured from the chain as it lies stretched upon the ground, by means of an offsetting staff. This staff should be 10 links in length, and

divided into links. With Gunter's chain the staff, then, will be 6·6 feet, or 6 feet 7·2 inches long, while with the 100 feet chain it will be 10 feet in length.

THE SPIRIT LEVEL.

Certain parts of the capital instruments used in surveying, and in astronomical observations, require to be adjusted in truly horizontal positions; and, to arrive at this adjustment, one or more subsidiary instruments, called spirit levels, are attached to such principal instruments. The spirit level attached to a good telescope, furnished with a compass, and such means of correct adjustment as we shall presently describe, becomes also itself a capital instrument, being used in that department of surveying, termed levelling, which consists in measuring the vertical distances between various stations.

The spirit level consists of a glass tube, differing from the cylindrical form by having its diameter largest in the middle, and decreasing slightly and with great regularity from the middle to the ends. The tube is nearly but not quite filled with spirits of wine, thus leaving in it a bubble of air, *b b*, which rises to the highest part of the tube, so as to have its two ends equally distant from the middle, when the instrument is in adjustment, as represented in the annexed figure.

The tube is generally fitted into another tube of metal, and attached to a frame terminating in angular bearings, by which the level can either be suspended from, or else be stood upon, cylindrical pivots. When, however, the level forms a permanent part of any instrument, the manner of attaching it is modified to suit the particular form of the instrument to which it is attached. A small and accurately-divided scale is attached to the best instruments, or otherwise a scale is scratched upon the glass tube itself, as represented in the figure given above.

The annexed figure is a representation of such a level as is used for levelling the axis of the best astronomical instruments. It is provided with a fixed

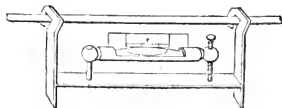

scale, seen in the figure, and is suspended by means of accurately constructed angular bearings.

The following criteria of a good level are extracted from

Dr. Pearson's valuable work on Practical Astronomy, before referred to.

"Firstly, the bubble must be long enough, compared with the whole tube, to admit of quick displacement, and yet not too long to admit of its proper elongation by low temperature.

"Secondly, the curve must be such, that the sensibility and uniform run of the bubble will indicate quantities sufficiently minute, while those quantities correspond exactly to the changes of inclination, as read on the graduated limb of the instrument of which it forms a part.

"Thirdly, the bubble must keep its station when the angles are moved a little round the pivots of suspension.

"Fourthly, the opposite ends of the bubble must vary alike in all changes of temperature, or, in other words, the ends of the bubble must elongate or contract alike in opposite directions, so that the middle point may always be stationary.

"Fifthly, the angles of the metallic end-pieces must be so nicely adjusted that reversion on horizontal pivots that are equal will not alter the place of the bubble.

"Sixthly, the distance between the two zeros of a fixed scale, when such a graduated scale is used, should be equal to the length of the bubble at the temperature of 60° of Fahrenheit's scale, and should be marked at equal distances from the visible ends of the glass tube. Then, as the bubble lengthens by cold, or shortens by heat, its extreme ends may always be referred to these fixed marks, 0 0, on the scale, and will fall either within, upon, or beyond them, according to the existing temperature. The number of subdivisions of the scale that each end of the bubble is standing at, counted from the fixed zero marks, at the instant of finishing an observation, must always be noted, that an allowance may be made for the value of the deviation in seconds, or as the case may require.

"Seventhly, when the two ends of the bubble are not alike affected by a change of temperature, the scale should be detached, and adjustable to the new zero points, by an inversion of the level.

"Eighthly, when the scale has only one zero at its center, which is a mode of dividing the least liable to misapprehension, the positions must be reversed at each observation, and both ends of the bubble read in each position; for in this case, if any change has taken place in the true position of this zero, the resulting error will merge in the reduction of the observation. This mode of graduating is generally practised on the continent."

We proceed now to the description of the most accurate instruments for measuring the differences of level, or vertical distances, between different stations.

Of spirit levels for this purpose there are now three in use, namely, the Y level, Troughton's improved level, and Gravatt's level.

THE Y LEVEL.

The following figure represents this instrument. A is an achromatic telescope, resting upon two supporters, which in shape resemble the letter Y, and are consequently called the Ys. The lower ends of these supporters are let perpendicu-

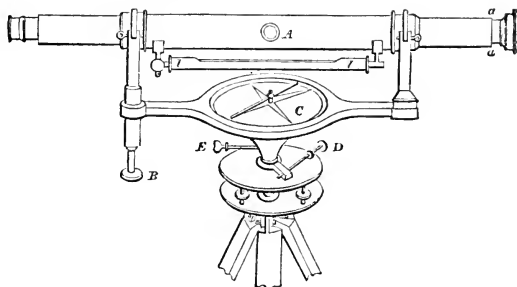

larly into a strong bar, which carries a compass box, *c*. This compass box is convenient for taking bearings, and has a contrivance for throwing the needle off its center, when not in use. One of the Y supporters is fitted into a socket, and can be raised or lowered by the screw *B*.

Beneath the compass box, which is generally in one piece with the bar, is a conical axis passing through the upper of two parallel plates, and terminating in a ball supported in a socket. Immediately above this upper parallel plate is a collar, which can be made to embrace the conical axis tightly by turning the clamping screw *E*, and a slow horizontal motion may then be given to the instrument by means of the tangent screw *D*. The two parallel plates are connected together by the ball and socket already mentioned, and are set firm by four milled-headed screws, which turn in sockets fixed to the lower plate, while their heads press against the under side of the upper plate, and thus serve the purpose of setting the instrument up truly level.

Beneath the lower parallel plate is a female screw, adapted to the staff-head, which is connected by brass joints with three mahogany legs, so constructed as, when shut together, to form one round staff, a very convenient form for portability, and, when opened out, to make a very firm stand, be the ground ever so uneven.

The spirit level *ll* is fixed to the telescope by a joint at one end, and a capstan-headed screw at the other, to raise or depress it for adjustment.

In looking through a telescope a considerable field of view is embraced; but the measurements indicated by any instru-

ment, of which the telescope may form a part, will only have reference to one particular point in this field of view, which particular point is considered as the center of this field of view. We must therefore place some fixed point in the field of view, and in the focus of the eye-piece, and the point to which the measurement will have reference will be that point of the object viewed, which appears to be coincident with this fixed point, or which, as the technical phrase is, is bisected by the fixed point.

The intersection of two fixed lines will furnish us with such a fixed point, and consequently two lines of spider's thread are fixed at right angles to each other in the focus of the eye-piece. They are attached by a little gum to a brass ring of smaller dimensions than the tube of the telescope, and which is fixed to the tube by four small screws, *a, b, c, d*. If the screw *d* be eased, while at the same time *c* is tightened, the ring will be moved to the right; but, if *c* be eased and *d* tightened, the ring will be moved to the left; and in a like manner it may be moved up or down by means of the screws *a* and *b*.

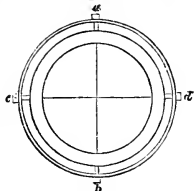

When the instrument is in adjustment, the axis of the tube of the telescope is set truly horizontal by means of the level beneath it, and the line of observation ought consequently to be parallel to this axis. Let Δ represent the proper position of the intersection of the cross wires, and o Δ , the direction of the axis of a pencil of light passing through the object-



glass and coming to its focus at Δ . Then, the axis of the tube of the telescope being set truly horizontal, the line $A O$ is also truly horizontal, and every point bisected by the intersection of the cross wires will be situated on the prolongation of the horizontal line $A O$.

Suppose now the position of the diaphragm carrying the cross wires to have become deranged, so that the point of intersection is moved to B , then every point bisected by the intersection of the cross wires will be on the prolongation of the line $B O$, and will consequently be below the true level point on the line $A O$.

Let now the telescope be turned half round in the Y s, and

let the annexed figure represent it in its new position ; then, in this new position of the telescope, the prolongation of the line $B o$ will rise above the prolongation of the level

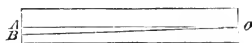

line $A o$, and, at the same distance from the telescope, the point now bisected by the intersection of the cross wires will be as much above the true level point on the line $A o$ as the point before bisected by them was below it. The true level point is therefore midway between the two points observed in the two positions of the telescope, and the diaphragm carrying the cross wires is to be moved by means of the screws a, b, c, d , till their point of intersection coincides with that true level point. The telescope is then to be again turned round upon the Ys , and, if the same point be still bisected by the intersection of the cross wires, they are in their proper position ; but, if not, the same method of adjustment must be repeated till the same point is bisected by the intersection of the cross wires in every position of the telescope.

This error of derangement has a technical denomination. The line $o A$, or $o B$, from o to the point of intersection of the cross wires, is called the *line of collimation*, and the error arising from their derangement, which we have shown the method of detecting and correcting, is called the *error of collimation*.

When the image of the object viewed, formed by the object-glass, either falls short of, or beyond the place of the cross wires, the error arising from this cause is called *parallax*. The existence of parallax is determined by moving the eye about when looking through the telescope, observing whether the cross wires change their position, and are flitting and undefined.

To correct this error, first adjust the eye-piece, by means of the moveable eye-piece tube, till you can perceive the cross wire clearly defined, and sharply marked against any white object.

Then by moving the milled-headed screw A , at the side of the telescope, the internal tube a is thrust outwards or drawn inwards, until you obtain the proper focus, according to the distance of the object, and you are enabled at once to see clearly the object, and the intersection of the wires, clearly and sharply defined, before it. The existence of parallax is very inconvenient, and, where disregarded, has frequently been productive of serious error. It will not always be found sufficient to set

the eye-glass first, and the object-glass afterwards. The setting of the object-glass, by introducing more distant rays of light, will affect the focus of the eye-glass, and produce parallax or indistinctness of the wires, when there was none before; the eye-piece must, in this case, be adjusted again.

Generally, when once set for the day, there is no occasion for altering the *eye-glass*, but the *object-glass* will of course have to be altered at every change of distance of the object.

In adjusting the instrument, the parallax should be first corrected, and then the error of collimation. The line of collimation being thus brought to coincide with the axis of the tube of the telescope, two further adjustments are necessary: the first to adjust the bubble-tube, so that it may truly indicate when the axis of the telescope is horizontal; and the second to set the axis of the telescope perpendicular to the vertical axis round which the instrument turns.

To adjust the Bubble-Tube.—Move the telescope till it lies in the direction of two of the parallel plate screws, and by giving motion to these screws bring the air bubble to the center of its run. Now reverse the telescope carefully in the Ys, that is, turn it end for end; and, should the bubble not settle at the same point of the tube as before, it shows that the bubble-tube is out of adjustment, and requires correcting. The end to which the bubble retires must then be noticed, and the bubble made to return one-half the distance by turning the parallel plate screws, and the other half by turning the capstan-headed screw at the end of the bubble-tube. The telescope must now again be reversed, and the operation be repeated, until the bubble settles at the same point of the tube, in the center of its run, in both positions of the instrument. The adjustment is then perfect, and the clips which serve to confine the telescope in the Ys should be made fast.

Lastly, to set the Axis of the Telescope perpendicular to the Vertical Axis round which the Instrument turns.—Place the telescope over two of the parallel plate screws, and move them, unscrewing one while screwing up the other, until the bubble of the level settles in the center of its run; then turn the instrument half round upon the vertical axis, so that the contrary ends of the telescope may be over the same two screws, and, if the bubble does not again settle at the same point as before, half the error must be corrected by turning the screw B, and the other half by turning the two parallel plate screws, over which the telescope is placed. Next turn the telescope a quarter round, that it may lie over the other two screws,

and repeat the process to bring these two screws also into adjustment; and when, after a few trials, the bubble maintains exactly the same position in the center of its run, while the telescope is turned all round upon the axis, this axis will be truly vertical, and the axis of the telescope, being horizontal by reason of the previous adjustment of the bubble-tube, will be perpendicular to that vertical axis, and remain truly horizontal, while the telescope is turned completely round upon the staves. The adjustment is therefore perfect.

The object of the above adjustments is to make the line of collimation move round in a horizontal plane, when the instrument is turned round its vertical axis, and the methods above explained suppose that the telescope itself is constructed with the utmost perfection, so that the axis of the tube carrying the object-glass is always in the same straight line with the axis of the main tube, which carries the diaphragm with the cross wires. If this perfection in the construction of the instrument does not exist, the line of collimation will vary, as the tube carrying the object-glass is thrust out, and drawn in, to adjust the focus for objects of different distances. What is really required, then, is that the cross wires be so adjusted that the line of collimation may be in the same straight line with the line in which the center of the object-glass is moved, and that the bubble of the level be at the center of its run, when this line of collimation is directed to view objects, at the same level, or at the same distance from the center of the earth.

We are indebted to Mr. Gravatt, of whose level we shall hereafter speak, for a method of collimating, which satisfies the above requirements, and removes any error arising from imperfection in the slide of the telescope, while at the same time the line of collimation is set with the end at the object-glass, slightly depressed, instead of exactly horizontal, so as to remove, or nearly so, the errors arising from the curvature of the earth, and the horizontal refraction.

To examine and correct the Collimation by Mr. Gravatt's Method.—"On a tolerably level piece of ground drive in three stakes at intervals of about four or five chains, calling the first stake *a*, the second *b*, and the third *c*.

"Place the instrument half way between the stakes *a* and *b*, and read the staff *A*, placed on the stake *a*, and also the staff *B*, placed on the stake *b*; call the two readings, A' and B' ; then, although the instrument be out of adjustment *,

* The axis of the instrument is to be set vertical by means of the parallel plate screws, by placing the telescope over each pair alternately, and moving them, until the air bubble remains in the same position, when the instrument is turned half round upon its axis.

yet the points read off will be equidistant from the earth's center, and consequently level.

"Now remove the instrument to a point half way between b and c . Again read off the staff B , and read also a staff placed on the stake c , which call staff C (the one before called A being removed into that situation). Now, by adding the difference of the readings on B (with its proper sign) to the reading on C , we get three points, say A' , B' , and C' , equidistant from the earth's center, or in the same true level.

"Place the instrument at any short distance, say half a chain beyond it, and, using the bubble merely to see that you do not disturb the instrument, read all three staffs, or, to speak more correctly, get a reading from each of the stakes, a , b , c ; call these three readings A'' , B'' , C'' . Now, if the stake b be half way between a and c *, then ought $C'' - C' - (A'' - A')$ to be equal to $2 [B'' - B' - (A'' - A')]$; but if not, alter the screws which adjust the diaphragm, and consequently the horizontal spider line, or wire, until such be the case; and then the instrument will be adjusted for collimation.

"To adjust the spirit bubble without removing the instrument, read the staff A , say it reads A''' , then adding $(A''' - A')$ with its proper sign to B' we get a value, say B''' .

"Adjust the instrument by means of the parallel plate screws†, to read B''' on the staff B .

"Now, by the screws attached to the bubble-tube, bring the bubble into the center of its run.

"The instrument will now be in complete practical adjustment for level, curvature, and horizontal refraction, for any distance not exceeding ten chains, the maximum error being only $\frac{1}{1000}$ th of a foot."

Before making observations with this instrument, the adjustments should be carefully examined and rectified, after which the screw B should never be touched; but at each station the parallel plate screws alone should be used for setting the axis round which the instrument turns truly vertical, when, in consequence of the adjustments previously made, the line of collimation will be truly level. For this purpose the telescope must be placed over each pair of the parallel plate screws alternately, and they must be moved till the air bubble settles in the middle of the level, and the operation being repeated till the telescope can be turned quite round upon the staff-head, without any change taking place in the position of the bubble, the instrument will be ready to read off the graduations upon the levelling staves, which we proceed to describe.

* Whatever be the distances between the stakes a , b , and c , the following proportions ought to hold, viz. :—

The distance from a to b : the distance a to c :: $B'' - B' - (A'' - A')$: $C'' - C' - (A'' - A')$.

† If this adjustment be made by the screw B , instead of the parallel plate screws, the line of collimation will be brought into its proper position with respect to the vertical axis.

The best constructed levelling staff* consists of three parts, which pack together for carriage in a neat manner, and, when opened out for use, form a staff seventeen feet long, jointed together something after the manner of a fishing-rod. The whole length is divided into hundredths of a foot, alternately coloured black and white, and occupying half the breadth of the staff; but for distinctness the lines denoting tenths of feet are continued the whole breadth, every half foot or five-tenths being distinguished by a conspicuous black dot on each side.

In all work where great accuracy is required, the Y level, above described, is preferable to either of the others; but both Troughton's level and Gravatt's level are calculated, by their lightness, and by their being less liable to derangement when once properly adjusted, to get rapidly over the ground

TROUGHTON'S LEVEL.

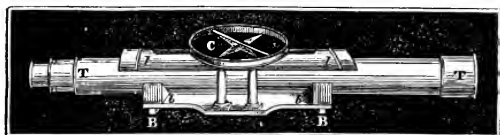

In this level the telescope, T, rests close down upon the horizontal bar, *bb*, the spirit level, *ll*, is permanently fixed to the top of the telescope, and does not, therefore, admit of adjustment, and the compass box, *c*, is supported over the level by four small pillars attached to the horizontal bar. This construction makes the instrument very firm and compact. The staves, staff-head, and parallel plates by which the instrument is supported, and the vertical axis upon which it turns, are of exactly the same construction as has been already described as used for supporting the Y level.

The diaphragm is furnished with three threads, two of them vertical, between which the levelling staff may be seen, and the third, horizontal, gives the reading of the staff by its coincidence with one of the graduations marked upon it. Sometimes a pearl micrometer-scale is fixed on the diaphragm, instead of the wires. The central division on the scale, then, indicates the collimating point, and by its coincidence with a division of the levelling staff gives the required reading of

* This staff was first introduced into use by William Gravatt, Esq.

this staff; and the scale serves the purpose of measuring distances approximately, and of determining stations nearly equidistant from the instrument, since at such equal distances the staff will subtend the same number of divisions upon the micrometer-scale.

In selecting a level of Troughton's construction, and also in testing and adjusting the collimation subsequently, Mr. Gravatt's method, already described, is the best to be used; and, when the line of collimation is thus brought into adjustment, if the bubble be far from the center of its run, the fault can only be remedied by the maker; but, if the bubble settle very nearly in the center of its run, the instrument may be deemed a good one, and, the divisions on the glass tube which coincide with the ends of the bubble being noted, the instrument must be set up for use with the bubble in this position.

The line of collimation is set perpendicular to the vertical axis, in the same manner as in the Y level, by means of the capstan screws, B B, the bubble being made to maintain the requisite position, as above determined, while the instrument is turned completely round on its axis.

MR. GRAVATT'S LEVEL.

This instrument is furnished with an object-glass of large aperture and short focal length; and, sufficient light being

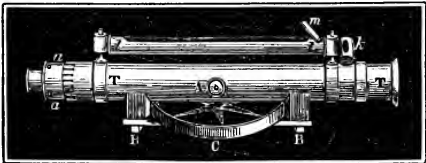

thus obtained to admit of a higher magnifying power in the eye-piece, the advantages of a much larger instrument are obtained, without the inconvenience of its length. The diaphragm is carried by the internal tube *aa*, which is nearly equal in length to the external tube. The external tube *rr* is sprung at its aperture, and gives a steady and even motion to the internal tube *aa*, which is thrust out, and drawn in, to adjust the focus for objects at different distances by means of the milled-headed screw *A*. The spirit level is placed above the telescope, and attached to it by capstan-headed screws,

one at either end, by means of which the bubble can be brought to the center of its run, as in the case of the Y level, when the line of collimation is brought to the proper level by Mr. Gravatt's method of adjustment, already explained.

The telescope is attached to a horizontal bar, in a similar manner to Troughton's level, but room is just left between the telescope and the bar for the compass-box.

A cross level, k , is placed upon the telescope at right angles to the principal level ll , by which we are enabled to set the instrument up at once with the axis nearly vertical. A mirror, m , mounted upon a hinge-joint, is placed at the end of the level ll , so that the observer, while reading the staff, can at the same time see that the instrument retains its proper position—a precaution by no means unnecessary in windy weather, or on bad springy ground.

The telescope is attached to the horizontal bar by capstan-headed screws, BB , as in Troughton's level, by which the line of collimation is set perpendicular to the vertical axis; and the instrument is set up upon parallel plates, as before described, for the Y level.

The operation of determining the difference of level between two stations by observations made at a single station is called *simple levelling*, and is performed as follows:—

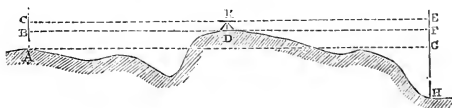

Let A and H be two points whose difference of level is required. Plant the instrument at D , and adjust it to a horizontal position. Read off AC , the height of a staff held at A , then turn the telescope round and read off EH , the height of a similar staff, or of the same staff held at H . Then AC is the height of κ , the axis of the telescope above the point A , and EH is the height of κ above another point, H ; and it is clear that $EH - AC = GH$, the difference of level between A and H .

In this operation the station A , at which the staff is first read off, is called the back station, and the station H is called the fore station; and, if the reading of the staff at the back station be greater than that at the fore station, the difference of level is called a rise; but, if the reading at the back station be less

than that at the fore, as in the example just given, the difference of level is called a fall.

When, from the nature of the ground, or the great distance between the two points, they cannot both be observed from a single spot, a series of simple levels must be taken, the fore station at each operation being made the back station at the next operation; and from the combination of all the results thus obtained the required difference of level is obtained. In these operations care must be taken, in going over soft ground, lest the staff at the fore station, when turned round to be read as the staff at the back station in the next operation, should sink further into ground; and, to prevent this, the foot of the staff must be placed upon a flat, hard substance, as a piece of slate or tile. There is a simple instrument called a tripod, sold for this purpose by the instrument makers, being simply a plate of iron with a small rounded projection in the center, two small spikes at the side to fix it in its place, and a short chain to lift it by, when the staff-holder wishes to remove from his place.

In determining by this method the difference of level between two distant points, it is immaterial by what route we proceed from one to another, so that such spots may be selected for the intermediate stations as are most convenient for the purpose. The bearings of the stations from the instrument are also matter of indifference; but, the more nearly the instrument is equidistant from the two stations observed at each operation, the more correct will be the result obtained, the errors in the back readings compensating, for the most part, the errors in the fore readings, whether the errors arise from refraction* and curvature†, or from the imperfect adjustment of the instrument.

If, then, the object be only to obtain the difference of level of two points, we have only to record in two separate columns the readings of the staff at the back stations and fore stations respectively, and the difference of the sums of these readings

* The error of refraction is that arising from the bending of the rays of light during their passage through the atmosphere, and makes all objects appear higher than they really are.

† The object of levelling is to determine points upon a spherical surface or equally distant from the earth's center, or to determine the differences of the distances of a series of points from the earth's centre. The line of sight, or prolongation of the line of collimation, however, is a tangent to the spherical surface, and therefore the points observed upon this line are really above the level of the point of observation. The correction for curvature is therefore additive, while that for refraction is subtractive.

will be the difference of level required.—Thus, if the difference of level between two points A and B, be required, and if the readings at A and B, and three intermediate stations $\odot 1$, $\odot 2$, $\odot 3$, be recorded as follows, viz.:—

		Back \odot	Fore \odot		
Reading of staff at		Feet.	Feet.	Reading of staff at	
	A . .	3·65	5·80	$\odot 1$	
"	$\odot 1$. .	2·05	8·50	$\odot 2$	
"	$\odot 2$. .	3·89	8·40	$\odot 3$	
"	$\odot 3$. .	5·28	14·35	"	B
		14·87	37·05		
			14·87		
			22·18		

Then 22·18 feet is the fall from A to B, or A is 22·18 feet above B.

When, however, it is required not only to find the difference of level between two distant points, but to make such observations as shall enable us to draw a section exhibiting the undulations of the ground along some specified route from the one point to the other, then the stations must be so chosen that one of them shall be at the commencement of each change in the inclination of the ground; the distances between the stations must also be carefully measured; and it is further advisable to note the distances and bearings of the stations from the instrument, which it will be more convenient now to place on a point in the specified route between the stations.

In drawing the section, it is the horizontal distances between the several stations that must be laid down. For short distances, or over very irregular ground, such horizontal measurements may be obtained by bidding an assistant hold one end of a measuring tape close to the ground at the highest end of the distance, and holding the other end above the ground, stretching the tape in a horizontal line, a stone let fall from this end then marking upon the ground the point to which the measurement reaches. But, when the ground rises and falls in long regular slopes, the measurements should be taken along the slopes, and then be reduced to horizontal distances by calculation. If the rise or fall is but slight, this reduction may be altogether disregarded, the difference between the horizontal and hypotenusal measurements not exceeding the limits of error in the measure itself.

Care should be taken to record all the observations in a clear and intelligible form, and for this purpose a field book may be prepared of the following form:—

	Distance to stations.		Bearings.	Staff readings.		Heights above datum.	Reduction.	Reduced horizontal distances.	REMARKS.
	From starting point.	From instruments.		Back.	Fore.				
Back ⊙	feet.	feet.	°	100.00		feet.			Back ⊙ 300 feet from hedge, wind-mill bearing 125° from instrument, church-spire bearing 223.5°.
		210	300.00	3.65		100.00			
Fore ⊙	460	250	120.10		5.00	3.65 103.65 5.90 97.85			
Back ⊙	460	180	300.00	2.05		97.85			Road to lime kilns.
						2.05 99.90 8.50 91.40			
Fore ⊙	3.20 730	140	120.00		8.50	91.40			
Back ⊙	730	180	299.75	3.09		91.40			
						3.09 95.29 8.40 86.89			
Fore ⊙	780 1160	200	119.40		8.40	86.89			
Back ⊙	1160	180	300.25	5.26		86.89			
						5.26 92.17 14.35 77.82			
Fore ⊙	360 1520	180	120.00		14.35	77.82			
Back ⊙	1520	300	300.00	12.25		77.82			Bottom of canal distant 150 feet.
						12.25 90.07 15.78 74.29			
Fore ⊙					15.78	74.29			
Back ⊙				15.78		74.29			
						15.78 90.07 9.21 80.86			
Fore ⊙	580 2100	230	120.00		9.21	80.86			
Back ⊙	2100	205	300.15	11.05		80.86			
						11.05 91.91 1.12 90.79			
Fore ⊙	400 2500	195	120.00		1.12	90.79			
		2500		153.95 63.16 90.79	63.16				

In the first column are entered the distances between the several stations, which, being successively added to the preceding total, give the total distances of each station from the starting point: in the next column are entered the distances of the stations from the instrument; and in the third are

entered the bearings of the stations from the instrument. In the fourth and fifth columns are entered the readings of the staves; and in the sixth column the heights above datum of the several stations are computed by adding the back reading to the height last found, and subtracting the fore reading from the sum. The seventh and eighth columns are added for performing the reduction of the measured distances to horizontal distances, when the slope is sufficient to render this reduction necessary. In carrying forward the distances to the next page of the book, the total reduced horizontal distance should be carried to the top of the first and second columns instead of the total measured distance along the slope; but such substitutions should not be made at any other part of the page, as it would interfere with the proof of the distances by adding up the second column, which ought to produce the last distance entered in the first. The levels are proved by subtracting the sum of the numbers in the sixth column from the sum of the numbers in the fifth, when the remainder should be the height above datum of the last station recorded at the bottom of the page.

To facilitate the reduction of the measured distances to the corresponding horizontal distances, the following table showing the reduction upon each 100 feet for each foot difference of level should be inserted in the field book:—

Difference of Level for 100 feet distance.	Reduction upon 100 feet of distance.	Difference of Level for 100 feet distance.	Reduction upon 100 feet of distance.	Difference of Level for 100 feet distance.	Reduction upon 100 feet of distance.
4	0.08	13	0.85	22	2.45
5	0.13	14	0.98	23	2.68
6	0.18	15	1.13	24	2.92
7	0.25	16	1.29	25	3.18
8	0.32	17	1.46	26	3.44
9	0.41	18	1.63	27	3.71
10	0.50	19	1.82	28	4.00
11	0.61	20	2.02	29	4.30
12	0.72	21	2.23	30	4.61

When it is required to plot the section on a large scale, and to show every undulation of the surface, it is not necessary to remove and re-set the instrument to obtain the height, above datum of every point necessary to be known for this purpose; but, besides reading the staff at the back and fore station, it may be read off from the same place of the instrument, at as many intermediate points as may be deemed

desirable; and these readings, being entered both as back and fore readings, will produce the same effect as back and fore readings of the same points obtained in different positions of the instrument. The distances from the instrument of these points should be omitted from the second column; but, the distances between them being entered successively in the first column, their respective distances from the instrument may at any time be determined, if required. The height of the instrument itself may be entered in this way as an intermediate sight; and, as the same height that is added as a back reading is subtracted again as a fore reading, any error in this reading will not at all affect the levels afterwards taken, and, provided it be not greater than the limit within which distances can be laid down and estimated upon the plot, is of no moment. Now, in taking the section of a line of any considerable extent, the scale is seldom sufficiently large to admit of less than six inches being laid down or estimated upon the plot, and consequently an error of two or three inches in the intermediate sights would be immaterial. When observations are made out of the line, to be levelled, in order, for instance, to obtain the height of this line above neighbouring rivers, canals, roads, &c., the readings are to be entered in the same manner as for other intermediate sights; and, the column of bearing and distance being left blank, no mistake can be made in drawing the section. The bearing and distance of such points, if desirable to be noted, must be entered in the space left for remarks.

For the purpose of reference on any future occasion, in order either to check the accuracy of the levels already obtained, or for the convenience of commencing a new series in some other direction, marks should be left upon some convenient fixed points upon which the staff has been held, and the reading noted with the greatest possible care. These bench marks, as they are called, should ordinarily be left at about every half-mile of distance, and may be either on or off the line. In the latter case the readings are to be recorded in the manner already explained for points out of the line. The hooks and tops of gates, copings, sills, or steps of doors, &c., are commonly used for bench marks, and the mark must be made exactly on the point upon which the staff has been held. A stout stake may be driven into the ground for a bench mark, and is by many persons preferred to any other.

When a section of considerable length is to be plotted, the horizontal distances cannot be laid down on as large a scale

as is necessary for the vertical heights above datum, in order that the section may be of any practical use, without making the plot of most unwieldy dimensions. It is therefore usual to make the vertical scale much larger than the horizontal one: thus 4 inches to a mile for the horizontal distances, with one inch to 100 feet for the vertical distances, is a usual combination. In the accompanying figure we have drawn the portion of a section from the portion of the field book at page 109, making use of a scale of 1 inch to 800 feet for the horizontal distances, and of a scale of 1 inch to 200 feet for the vertical distances

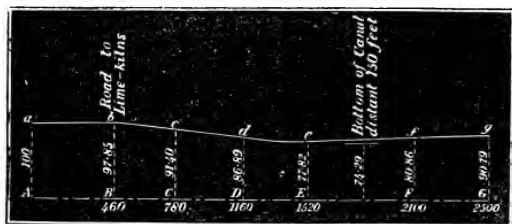

A G is ruled for the datum line; on it are set off from A, the horizontal distances at the points B, C, D, E, F, G, according to the horizontal scale of 1 inch for each 800 feet, and through the points A, B, C, D, E, F, and G, are drawn lines A a, B b, &c., perpendicular to A G; on these lines are set off the vertical distances to the points a, b, c, &c., according to the vertical scale of 1 inch for each 200 feet; and the line a g, passing through all the points a, b, c, &c., will represent the required section. A line is drawn between the stations E, F, at the proper distance from the datum line to represent the level of the canal; and proceeding in this manner, and making any remarks that may seem desirable, opposite the corresponding points of the section, the work will be completed.

Having now explained the construction and use of the most accurate instruments for tracing the level of any portion of country, we proceed to notice the *water level*, a very simple instrument, adapted to give a rapid delineation of any portion of country, an object frequently of greater importance than accuracy. It can be made by any workman, will cost but a few shillings, and requires no adjustment when using it.

“ A B is a hollow tube of brass, about half an inch in diameter,

and about 3 feet long; *c* and *d* are short pieces of brass tube of larger diameter, into which the long tube is soldered, and are for the purpose of receiving the two small bottles, *e* and *f*, the ends of which, after the bottoms have been cut off, by tying a piece of string round them when heated, are fixed in their positions by putty or white lead; the projecting short

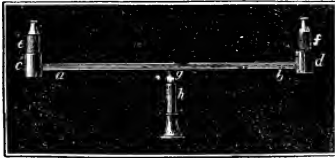

axis, *g*, works (in the instrument from which the sketch was taken) in a hollow brass cylinder, *h*, which forms the top of a stand used for observing with a repeating circle; but it may be made in a variety of ways, so as to revolve on any light portable stand. The tube, when required for use, is filled with water (coloured with lake or indigo), till it nearly reaches to the necks of the bottles, which are then corked for the convenience of carriage. On setting the stand tolerably level by the eye, these corks are both withdrawn, which must be done carefully, and when the tube is nearly level, or the water will be ejected with violence; and the surface of the water in the bottles, being necessarily on the same level, gives a horizontal line in whatever direction the tube is turned, by which the vane of a levelling staff is adjusted."

The instrument, however, with which observations upon the level of a country may be most expeditiously made, and generally with greater correctness than with the water level, is the reflecting level. This instrument consists merely of a piece of common looking-glass, *l l*, one inch square, set in a frame fixed against a plate of metal weighing about a pound, and suspended from a ring, *r*, by a twisted wire, *w*, so that it may swing freely, but not turn round on its axis of suspension. A fine silk thread, *t t*, is stretched across the center of the mirror, and a small opening, *o*, at one side of the mirror.



The instrument is adjusted as follows. It is suspended in a frame, constructed to hold it, and bring it soon to rest, at about 50 yards in front of a wall. The observer looks into the mirror, and brings his eye into such a position that its image is bisected by the silk thread, tt ; and the point upon the wall, seen through the opening, o , which coincides with the silk thread, is marked upon the wall. The mirror is then turned round, and the point is also marked upon the wall, the reflection of which in the mirror now coincides with the silk thread, when this thread again bisects the image of the observer's eye as before.

Lastly, the middle point, between the two thus found, is marked upon the wall; and by turning a screw, s , the center of gravity of the instrument is altered, till the mirror hangs so as to bring the reflection of this last mark upon the thread, when the observer's eye is bisected by it. The instrument will now be in perfect adjustment, and, when the image of the eye is brought upon the thread, all points bisected by the thread, whether seen by reflection, or directly through the opening, o , will be on the same level with the eye of the observer. The observations may be made either by holding the instrument at arm's length, or by suspending it from the branch of a tree, or from any post or rail of a convenient height. Greater accuracy is obtained by suspending it by means of a frame fitting on a three-legged stand, such as already described as used for supporting the more accurate instruments; but it must not be forgotten that this instrument is not to be at all compared with them for minute accuracy; but that its advantages are the great rapidity with which it can be used, whether in a very confined space, or in an open country.

INSTRUMENTS FOR MEASURING ANGLES.

In every map and plan the distances and angles laid down are not the actual distances and angles between the points of which the relative positions are intended to be represented, but they are the distances and angles between the projections* of those points upon the same horizontal plane, and are called the horizontal angles and distances between the points. Now, if our surveying instruments were constructed to measure the actual angles subtended by different objects, the process of calculating all the horizontal angles from these observed angles would be very laborious; but, by having such instru-

* The projection of a point upon a horizontal plane is the point in which a vertical line through that point meets the horizontal plane.

ments as will at once determine by observation the horizontal angles, we are saved a vast amount of labour, and also from any errors which might otherwise creep into the calculations.

THE PRISMATIC COMPASS.

With this instrument horizontal angles can be observed with great rapidity, and, when used with a tripod stand, with a considerable degree of accuracy. It is, consequently, a very valuable instrument to the military surveyor, who can make his observations with it, while holding it in his hand, with all the accuracy necessary for a military sketch. It is also a useful instrument for filling in the detail of an extensive survey*, after the principal points have been laid down by means of observations made with the theodolite, hereafter to be described, and for any purpose, in short, in which the portability of the instrument and rapidity of execution are of more importance than extreme accuracy.

c is a compass card divided usually to every 20', or third part of a degree, and having attached to its under side a magnetic needle, which turns upon an agate center, *o*, fixed in the box *B*; *n* is a spring, which, being touched by the finger, acts upon the card, and checks

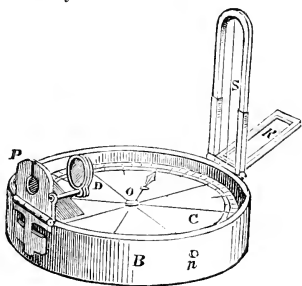

its vibrations, so as to bring it sooner to rest, when making an observation. *s* is the sight-vane, having a fine thread stretched along its opening, by which the point to be observed with the instrument is to be bisected. The sight-vane is mounted upon a hinge-joint, so that it can be turned down flat in the box when not in use. *p* is the prism attached to a plate sliding in a socket, and thus admitting of being raised or lowered at pleasure, and also supplied with a hinge-joint, so that it can be turned down into the box when not in use. In the plate to which the prism is attached, and which projects beyond the

* The prismatic compass was used for this purpose by the gentlemen engaged in making the ordnance surveys.

prism, is a narrow slit, forming the sight through which the vision is directed when making an observation. On looking through this slit, and raising or lowering the prism in its socket, distinct vision of the divisions on the compass card immediately under the sight-vane is soon obtained, and these divisions, seen through the prism, all appear, as each is successively brought into coincidence with the thread of the sight-vane by turning the instrument round, as continuations of the thread, which is seen directly through the part of the slit that projects beyond the prism.

The method of using the instrument is as follows:—The sight-vane *s*, and the prism *p*, being turned up upon their hinge-joints as represented in our figure, hold the instrument as nearly in a horizontal position as you can judge, or, if it be used with a tripod stand, set it as nearly as you can in a horizontal position by moving the legs of the stand, so that the card may play freely. Raise the prism in its socket till the divisions upon the card are seen distinctly through the prism, and, turning the instrument round, until the object to be observed is seen through the portion of the slit projecting beyond the prism in exact coincidence with the thread of the sight-vane, bring the card to rest by touching the spring *n*; and then the reading at the division upon the card, which appears in coincidence with the prolongation of the thread, gives the magnetic azimuth of the object observed, or the angle which a straight line, drawn from the eye to the object, makes with the magnetic meridian*. The magnetic azimuth of a second object being obtained in the same manner, the difference between these two azimuths is the angle subtended by the objects at the place of the eye, and, which is an important point, is independent of any error in the azimuths, arising from the slit in the prism not being diametrically opposite to the thread of the sight-vane.

For the purpose of taking the bearings of objects much

* The magnetic meridian now makes an angle of 24° with the true meridian, at London, the north point of the compass being 24° west of the true north point. This angle is called the variation of the compass, and is different at different places, and also at the same place at different times. Since this variation will affect equally, or nearly so, all azimuths observed within a limited extent and during a limited time, the angles subtended by any two of the objects observed, being the difference of their azimuths, will not be affected by the variation, and hence the map, or plan, may be constructed with all the objects in their proper relative positions; but the true meridian must be laid down, if required, by observations made for the purpose.

above or below the level of the observer, a mirror, *R*, is supplied with the instrument, which slides on and off the sight-vane *s*, with sufficient friction to remain at any part of the vane that may be desired. It can be put on with its face either upwards or downwards, so as to reflect the images of objects considerably either above or below the horizontal plane to the eye of the observer; and, if the instrument be used for obtaining the magnetic azimuth of the sun, it must be supplied with dark glasses, *D*, to be interposed between the sun's image and the eye.

There is a stop in the side of the box, not shown in our figure, by touching which a little lever is raised and the card thrown off its center; as it always should be when not in use, or the constant playing of the needle would wear the fine agate point upon which it is balanced, and the sensibility of the instrument would be thereby impaired. The sight-vane and prism being turned down, a cover fits on to the box, which is about three inches in diameter, and one inch deep; and the whole, being packed in a leather case, may be carried in the pocket without inconvenience*.

THE BOX SEXTANT.

This instrument, which is equally portable with the prismatic compass, forming, when shut up, a box of about three inches in diameter, and an inch and a half deep, will measure the actual angle between any two objects to a single minute. It requires no support but the hand, is easily adjusted, and, when once adjusted, but seldom requires re-adjusting.

When the sextant is to be used, the lid, *E*, of the box is taken off and screwed on to the bottom, where it makes a convenient handle for holding the instrument. The telescope, *T*, being then drawn

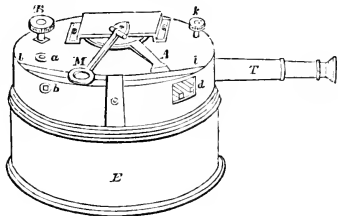

* For much valuable information respecting the use of the prismatic compass, especially in military surveying and sketching, we can refer our readers to a Treatise on Military Surveying, &c., by Lieutenant-Colonel Basil Jackson, in which the subject is handled with great ability.

out, the instrument appears as represented in our figure. A is an index arm, having at its extremity a vernier, of which 30 divisions coincide with 29 of the divisions upon the graduated limb, *ll*; and the divided spaces upon the limb denoting each 30 minutes, or half a degree, the angles observed are read off by means of the vernier to a single minute. The index is moved by turning the milled head, B, which acts upon a rack and pinion within the box. To the index arm is attached a mirror, called the index glass, which moves with the index arm, and is firmly fixed upon it by the maker, so as to have its plane accurately perpendicular to the plane in which the motion of the index arm takes place, and which is called the plane of the instrument. This plane is evidently the same as the plane of the face of the instrument, or of the graduated limb, *ll*. In the line of sight of the telescope is placed a second glass, called the horizon glass, having only half its surface silvered, and which must be so adjusted that its plane may be perpendicular to the plane of the instrument, and parallel to the plane of the index glass when the index is at zero. The instrument is provided with two dark glasses, which can be raised or lowered by means of the little levers seen at *d*, so as to be interposed, when necessary, between the mirrors and any object too bright to be otherwise conveniently observed, as the sun. The eye-end of the telescope is also furnished with a dark glass, to be used when necessary.

The principle upon which the sextant is constructed has been proved at page 75; viz. that the total deviation of a ray of light, after reflection successively at the index glass and horizon glass, is double the inclination of the two glasses. Now the limb, *ll*, being divided into spaces, each of 15' extent, and these spaces being figured as 30' each, the reading of the limb gives double the angle moved over by the index arm from the position in which the reading is zero, or double the angle of inclination of the two mirrors, if these mirrors be parallel when the reading is zero. If, then, the instrument be in perfect adjustment, and any object be viewed by it after reflection at both the mirrors, the reading of the instrument gives the total deviation of the rays of light, by which the vision is produced, or the angle between the bearing of the object from the center of the index mirror, and the bearing of the reflected image from the place of the eye, that is, between lines drawn respectively from the object to the center of the index glass, and from the reflected image in the horizon glass

to the eye. This angle is very nearly equal to the angle subtended by the object and its image at the place of the eye, differing from it only by the small angle subtended at the object by the place of the eye and the center of the index glass. This small angle is called the parallax of the instrument, and is scarcely perceptible at the distance of a quarter of a mile, while for distances greater than that it is so small that it may be considered to vanish. It also varies with the amount of deviation, and vanishes altogether whenever the center of the index glass is in a direct line between the object and the eye*.

To see if the instrument be in perfect adjustment, place the dark glass before the eye-end of the telescope, and looking at the sun, and moving the index backwards and forwards a little distance on either side of zero, the sun's reflected image will be seen to pass over the disc as seen directly through the horizon glass, and if in its passage the reflected image completely covers the direct image, so that but one perfect orb is seen, the horizon glass is perpendicular to the plane of the instrument; but, if not, the screw at *a* must be turned by the key, *k*, till such is the case. The key, *k*, fits the square heads of both the screws seen at *a* and *b*, and fits into a spare part of the face of the instrument, so as to be at hand when wanted. This adjustment being perfected, bring the reflected image of the sun's lower limb in exact contact with the direct image of his upper limb, and note the reading of the vernier; then move the index back beyond the zero division of the limb, till the reflected image of the sun's upper limb is in exact contact with the direct image of his lower limb, and, if the zero of the vernier be now exactly as far behind the zero of the limb as it was at the former reading in front of it, so that the reading now on the part of the limb called the arc of excess, behind its zero division†, be the same as the former reading,

* We have seen a method given for what is called correcting the parallax, when an observation is made at a short distance, by finding the deviation at this distance, when the angle between the object and its image is equal to zero; this deviation being given by the reading of the instrument, when the reflected image of the object observed exactly coincides with the object itself, seen through the unsilvered part of the horizon glass. This deviation, however, is not the parallax, even for a small angle between the object and its image, and, if the angle be not very small, the error introduced by the method will be greater than the parallax itself.

† In reading an angle upon the arc of excess, the division to read on the limb is that next in front of the zero of the vernier, or between the zero of the vernier and the zero of the limb, and the divisions of the vernier itself are to be read from the end division, marked 30, and not, as usually, from

the instrument is in perfect adjustment; but, if not, half the difference of the two readings is the amount of the error, and is called the index error, being a constant error, for all angles observed by the instrument, of excess, if the first reading be the greatest, and of defect, if the second reading on the arc of excess be the greatest.

In the former case, then, the true angle will be found by subtracting the index error from, and in the latter by adding it to, the reading of the instrument at every observation.

This method of correcting for the index error is to be used with the larger instruments, hereafter to be described under the head of Astronomical Instruments; but in the box sextant this error should be removed by applying the key, *k*, to the screw at *b*, and turning it gently till both readings are alike, each being made equal to half the sum of the two readings first obtained. When this adjustment is perfected, if the zeros of the vernier and limb are made exactly to coincide, the reflected and direct image of the sun will exactly coincide, so as to form but one perfect orb, and the reflected and direct image of any line, sufficiently distant not to be affected by parallax, as the distant horizon, or the top or end of a wall more than half a mile off, will coincide so as to form one unbroken line.

To obtain the angle subtended by two objects situated nearly or quite in the same vertical plane, hold the instrument in the right hand, and bring down the reflected image of the upper object by turning the milled head *B*, till it exactly coincides with the direct image of the lower object, and the reading of the instrument will give the angle between the two objects.

To obtain the angle subtended by two objects nearly in the same horizontal plane, hold the sextant in the left hand, and bring the reflected image of the right-hand object into coincidence with the direct image of the left-hand object.

It will be seldom that the surveyor need pay any attention to the small error arising from parallax; but, should great accuracy be desirable, and one of the objects be distant while the other is near, the parallax will be eliminated by observing the distant object by reflection, and the near one by

the zero division: thus, if the zero division of the vernier were a little further from the zero division of the limb, then the first division on the arc of excess; and if the twenty-seventh division on the vernier, or the third from the end division, marked 30, coincided with a division upon the limb, then the reading would be 33'.

direct vision, holding the instrument for this purpose with its face downwards if the distant object be on the left hand. If both objects be near, the reflected image of a distant object, in a direct line with one of the objects, must be brought into coincidence with the direct image of the other object, and the parallax will thus be eliminated.

For the purposes of surveying, the horizontal angles between different objects are required, and the reduction of these angles from the actual oblique angles subtended by the objects, would be a troublesome and laborious process. If the angle subtended by two objects be large, and one be not much higher than the other, the actual angle observed will be, however, a sufficient approximation to the horizontal angle required; and, if the angle between the two objects be small, the horizontal angle will be obtained with sufficient accuracy by taking the difference of the angles observed between each of the objects, and a third object at a considerable angular distance from them. With a little practice the eye will be able to select an object in the same direction as one of the objects, and nearly on a level with the other object, and the angle between this object and the object selected will be the horizontal angle required.

At sea the altitude of an object may be determined by observing the angle subtended by it and the verge of the horizon; but upon land a contrivance, called *an artificial horizon*, becomes necessary for correctly determining altitudes. The best kind of artificial horizon consists of an oblong trough, *t t*, filled with mercury, and protected from the wind by a roof, *r r*, having in either slope a plate of glass with its two surfaces ground into perfectly parallel planes. The angle *s e s'* between the object and its reflected image seen in the mercury is double the angle of elevation *s e H*, and, the angle *s e s'* being observed, its half will consequently be the angle of elevation re-

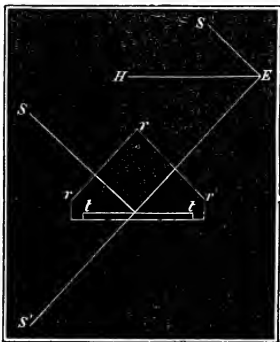

quired. If the angle of elevation be greater than 60° , the angle $s E s'$ will be greater than 120° , and cannot be observed with the sextant we have been describing.

The pocket sextant is a most convenient instrument for laying off offsets or perpendicular distances from a station line; for by setting the index at 90° , and walking along the station line, looking through the horizon glass directly at the further station staff, or any other remarkable object upon the station line, any object off the station line will be seen by reflection when the observer arrives at the point where the perpendicular from this object upon the station line falls, and the distance from this point to the object being measured, is its perpendicular distance from the station line.

For the mere purpose of measuring offsets an instrument called an *optical square* is now very generally employed, which consists of the two glasses of the sextant fixed permanently at an angle of 45° , so that any two objects seen in it, the one by direct vision, and the other by reflection, subtend at the place of the observer an angle of 90° .

THE THEODOLITE.

The theodolite is the most important instrument used by surveyors, and measures at the same time both the horizontal angles subtended by each two of the points observed with it, and the angles of elevation of these points from the point of observation

This instrument may be considered as consisting of three parts; the parallel plates with adjusting screws fitting on to the staff head, of exactly the same construction as already described for supporting the Y, and other, levels; the horizontal limb, for measuring the horizontal angles; and the vertical limb, for measuring the vertical angles, or angles of elevation.

The horizontal limb is composed of two circular plates, r and v , which fit accurately one upon the other. The lower plate projects beyond the other, and its projecting edge is sloped off, or chamfered, as it is called, and graduated at every half degree. The upper plate is called the vernier plate, and has portions of its edge chamfered off, so as to form with the chamfered edge of the lower plate continued portions of the same conical surface. These chamfered portions of the upper plate are graduated to form the verniers, by which the limb is subdivided to single minutes. The five-inch theodolite represented in our figure has two such ver-

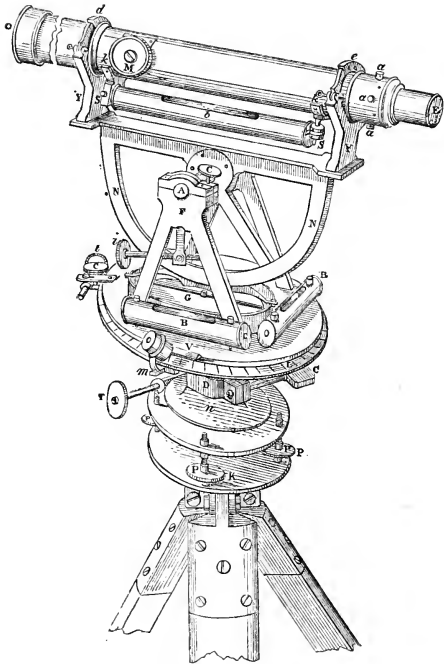

A Five-Inch Theodolite.

niers, 180° apart. The lower plate of the horizontal limb is attached to a conical axis passing through the upper parallel plate, and terminating in a ball fitting in a socket upon the lower parallel plate, exactly as the vertical axis of the Y level already described. This axis is, however, hollowed to receive a similar conical axis ground accurately to fit it, so that the axes of the two cones may be exactly coincident, or parallel*

* Upon this depends, in a great measure, the perfection of the instrument, as far as the horizontal measurements are concerned; and, when we

To the internal axis the upper, or vernier, plate of the horizontal limb is attached, and thus, while the whole limb can be moved through any horizontal angle desired, the upper plate only can also be moved through any desired angle, when the lower plate is fixed by means of the clamping screw, *c*, which tightens the collar, *d*. *T* is a slow-motion screw, which moves the whole limb through a small space, to adjust it more perfectly, after tightening the collar, *d*, by the clamping screw, *c*. There is also a clamping screw, *c*, for fixing the upper, or vernier, plate to the lower plate, and a tangent screw, *t*, for giving the vernier plate a slow motion upon the lower plate, when so clamped. Two spirit levels, *B, B*, are placed upon the horizontal limb, at right angles to each other, and a compass, *G*, is also placed upon it in the center, between the supports, *F, F*, for the vertical limb.

The vertical limb, *NN*, is divided upon one side at every 30 minutes, each way from 0° to 90° , and subdivided by the vernier, which is fixed to the compass box, to single minutes. Upon the other side are marked the number of links to be deducted from each chain, for various angles of inclination, in order to reduce the distances, as measured along ground rising or falling at these angles, to the corresponding horizontal distances. The axis, *A*, of this limb must rest, in a position truly parallel to the horizontal limb, upon the supports, *FF*, so as to be horizontal when the horizontal limb is set truly level, and the plane of the limb, *NN*, should be accurately perpendicular to its axis. To the top of the vertical limb, *NN*, is attached a bar which carries two *Y*s for supporting the telescope, which is of the same construction as that before described for the *Y* spirit level, and underneath the telescope is a spirit level, *ss*, attached to it at one end by a joint, and at the other end by a capstan-headed screw as in the *Y* level. The horizontal axis, *A*, can be fixed by a clamping screw, *c*, and the vertical limb can then be moved through a small space by a slow-motion screw, *i*.

Before commencing observations with this instrument, the following adjustments must be attended to:—

1. Adjustments of the telescope: viz.,
 the adjustment for parallax.
 ————— for collimation.
2. Adjustment of the horizontal limb: viz.,
 to set the levels on the horizontal limb to indicate the verticality of
 the azimuthal axis.

describe presently the adjustments of the instrument, we shall explain the method of detecting an inaccuracy in the grinding of the axes.

3. Adjustment of the vertical limb : viz.,
to set the level beneath the telescope to indicate the horizontality of the line of collimation.

1. *Parallax and Collimation.*—These adjustments have already been described (p. 100) under the head of the Y level.

2. *Adjustment of the Horizontal Limb.*—Set the instrument up as accurately as you can by the eye, by moving the legs of the stand. Tighten the collar, *d*, by the clamping screw, *c*, and, unclamping the vernier plate, turn it round till the telescope is over two of the parallel plate-screws. Bring the bubble, *b*, of the level, *s s*, beneath the telescope to the center of its run by turning the tangent screw, *i*. Turn the vernier plate half round, bringing the telescope again over the same pair of the parallel plate screws; and, if the bubble of the level be not still in the center of its run, bring it back to the center, half way by turning the parallel plate screws over which it is placed, and half way by turning the tangent screw, *i*. Repeat this operation till the bubble remains accurately in the center of its run in both positions of the telescope; and, then turning the vernier plate round till the telescope is over the other pair of parallel plate screws, bring the bubble again to the center of its run by turning these screws. The bubble will now retain its position while the vernier plate is turned completely round, showing that the internal azimuthal axis about which it turns is truly vertical. The bubbles of the levels on the vernier plate, being now, therefore, brought to the centers of their tubes, will be adjusted to show the verticality of the internal azimuthal axis. Now, having clamped the vernier plate, loosen the collar, *d*, by turning back the screw, *c*, and move the whole instrument slowly round upon the external azimuthal axis, and if the bubble of the level *s s*, beneath the telescope, maintains its position during a complete revolution, the external azimuthal axis is truly parallel with the internal, and both are vertical at the same time; but, if the bubble does not maintain its position, it shows that the two parts of the axis have been inaccurately ground, and the fault can only be remedied by the instrument-maker.

3. *Adjustment of the Vertical Limb.*—The bubble of the level, *s s*, being in the center of its run, reverse the telescope end for end in the *Ys*, and, if the bubble does not remain in the same position, correct for one-half the error by the capstan-headed adjusting screw at one end of the level, and for the other half by the vertical tangent screw, *i*. Repeat the opera-

tion till the result is perfectly satisfactory. Next turn the telescope round a little both to the right and to the left, and, if the bubble does not still remain in the center of its run, the level, *s s*, must be adjusted laterally by means of the screw at its other end. This adjustment will probably disturb the first, and the whole operation must then be carefully repeated. By means of the small screw fastening the vernier of the vertical limb to the vernier plate over the compass box, the zero of this vernier may now be set to the zero of the limb, and the vertical limb will be in perfect adjustment.

With an increase in the size of the theodolite a second telescope is placed beneath the horizontal limb, which serves to detect any accidental derangement of the instrument during an observation, by noting whether it is directed to the same point of a distant object at the end of the observation to which it has been set at the commencement of the observation. Also the vertical limb, in the larger theodolites, admits of an adjustment to make it move accurately in a vertical plane, when the horizontal limb has been first set in perfect adjustment. This adjustment is important, and should be examined with great care; and in the small theodolites, when the vertical limb is permanently fixed to the horizontal limb by the maker, an instrument which will not bear the test of the examination which we proceed to describe must be condemned, till set in better adjustment by the maker. The azimuthal axis having been set truly vertical, direct the telescope to some well-defined angle of a building, and making the intersection of the wires exactly coincide with this angle near the ground, elevate the telescope by giving motion to the vertical limb, and, if the adjustment be perfect, the intersection of the cross wires will move accurately along the angle of the building, still continuing in coincidence with it. A still more perfect test will be to make the intersection of the cross wires coincide with the reflected image of a star in an artificial horizon, and elevating the telescope, if the adjustment be perfect, the direct image of the star itself will again be bisected by the cross wires.

In the conduct of an extensive survey, the two principal desiderata are accuracy and despatch, neither of which should be unduly sacrificed to the other. To obtain both these ends, the principal points of the survey should be determined by a system of triangles proceeding from an accurately-measured base of considerable length. The angles of these triangles should be observed with a large and perfect theodolite con-

structed for the purpose, or with an altitude and azimuth instrument; and numerous corrections should be applied for the spherical form of the earth, the refraction of the atmosphere, the errors due to the imperfect graduation of the instrument, &c.

The boundaries of the entire country to be surveyed being thus determined with the greatest possible accuracy, and a series of stations laid down throughout, the spaces included between these stations may be subdivided into spaces of smaller extent, the boundaries of which may be surveyed with considerable despatch by means of the chain, and a portable theodolite, such as we have been describing above, and lastly, the details of the country within these spaces may be sketched with still greater rapidity by means of the prismatic compass.

The boundaries of the spaces to be surveyed by the chain and small theodolite should not exceed three or four miles in extent, and the following is the manner of proceeding.

Let a, b, c, d, e, f , represent the boundary to be surveyed, and let A, B , and C , be three stations which have been accurately laid down by the previous triangulation, of which both B and C can be seen from A , and A can be seen from C . First measure with the chain the lengths of the several lines $a b, b c, c d$, &c., taking offsets to all remarkable points on either side of these lines in the usual manner, and driving pickets at a, b, c , &c. Measure also the distance from A to a , and from d to C . These measurements having been made, set up the theodolite at A , level it, and clamp the vernier plate to the lower plate of the horizontal limb at zero, or so that the readings of the two verniers may be 360° and 180° respectively, this adjustment being perfected by the slow-motion screw, t . Next move the whole instrument round upon the azimuthal axis, till the object B is accurately bisected by the cross wires, clamp it firmly in this position by the screw c , tightening the collar D , and enter in the field book the reading of the compass. Now release the vernier plate, and turning it round, bisect the object C , by the cross wires, and enter the readings of both verniers in the field book. Observing, in like manner, the bearings of any other remarkable objects, and, entering the readings in the same way, direct the telescope lastly to a , at which station an assistant must be placed, with a staff held upon the picket there driven into the ground, and, entering the reading of the vernier as before, clamp the vernier plate carefully, and remove the instrument to a . Level the instrument at a , unclamp the collar D , and, turning round the whole in-

strument upon the azimuthal axis, direct the telescope to the last station A , tighten the collar D , and perfect the adjustment, if necessary, by the slow-motion screw T . Now release the vernier plate, and, bringing it back to zero, if the reading of the compass be the same as the reading previously entered in the field book, we assume our work, as far as it has gone, to be correct; but, if not, we must go back to A , and go over the work again*. Next release the vernier plate, and enter the readings, when the telescope is directed to the several remarkable points visible from a , and lastly direct the telescope to

the next forward station b , as before. In the same manner proceed from b to c , c to d , and d to e ; and, having directed the telescope at c to the last back station d , and released the vernier plate, direct the telescope to A ; and, if all the angles have been correctly measured up to this

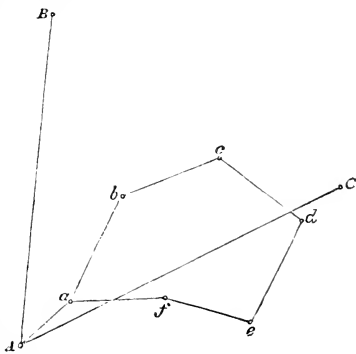

time, the reading of the vernier will now be the same as when the telescope was directed to c from the point A . If then we have not been able to make all the compass readings agree at the previous stations, after going twice over the work at such stations we may now consider that our work was correct, and that the error in the compass reading arose from some local attraction, or extraordinary variation of the needle. This verification of the work at c is called *closing the work*. We now come back again to d , and proceed from d to e , and so on, as before, till we come to some other station, which has been observed either from A or c , and which we again close upon, and at last arriving at f , if the readings agree within a minute or two with the readings for f , previously observed at

* If the same result is again arrived at, we may presume that the compass is acted on by some local attraction, and proceed with the work; and the accuracy of this presumption will be further tested as we go on.

a, the whole work may be considered to have been performed with a sufficient degree of accuracy; but, if the error amount to more than a minute or two, we must proceed back again from *f* to *e*, and so on till we find out the station at which the error has occurred. If the ground along any of the lines *a b*, *b c*, &c., rise or fall, suppose, for instance, along *b c*, then we must direct the telescope from *b*, so as to make the cross wires bisect upon the staff, held upon the picket at *c*, a point at the same distance from the ground as the center of the telescope, and then upon one side of the vertical limb is pointed out the number of links to be deducted for each chain from the measured distance *b c*, to reduce it to the required horizontal distance. This reduction is then to be entered in the field book*.

INSTRUMENTS FOR PLOTTING THE SURVEY.

In plotting the survey, as in taking it, due regard must be had to both accuracy and despatch, and we should aim to lay down the various points observed with an accuracy proportionate to the accuracy of the survey itself. To this end the principal points should be laid down by setting off with the beam compasses the computed sides of the triangles, the angles of which have been accurately observed with the large theodolite; and the direction of the meridian is to be laid down from an observation of the angle which it makes, with a side of one of these triangles, by means of the computed chords†, which chord is also to be set off with the beam compasses.

THE CIRCULAR PROTRACTOR.

The principal points having thus been laid down, the boundaries observed by the small theodolite may be put in by first laying down upon the paper a large circular protractor. This protractor may be pricked off by means of the circular metallic protractor represented in the accompanying figure, and the lines can then be transferred to any part of the paper by means of a large ruler and triangle, or by any parallel ruler. The circular protractor is a complete circle, *AA*, connected with its center by four radii, *a a a a*. The center is left open, and surrounded by a concentric ring, or collar, *b*, which carries

* The method of surveying with the chain and theodolite, explained above, is called surveying by a traverse.

† If a table of chords be not at hand, take out the sine of half the angle from a table of natural sines, and, reckoning the first figure as integral, this will be the chord of the whole angle to radius 5, or, reckoning the first two figures integral, it will be the chord to radius 50.

two radial bars, *c c*. To the extremity of one bar is a pinion, *d*, working in a toothed rack quite round the outer circumference of the protractor. To the opposite extremity of the other bar, *c*, is fixed a vernier, which subdivides the primary divisions on the protractor to single minutes, and by estimation to 30 seconds. This vernier, as may readily be understood from the engraving, is carried round the protractor by turning the pinion *d*. Upon each radial bar, *c c*, is placed a branch *e e*, carrying at its extremity a fine steel pricker, whose point is kept above the surface of the paper by a spring placed

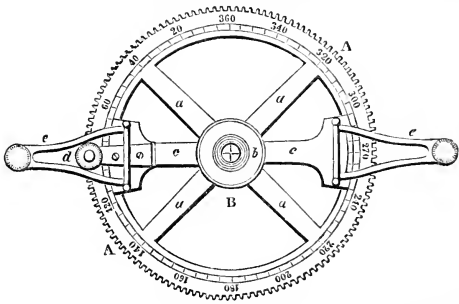

under its support, which gives way when the branch is pressed downwards, and allows the point to make the necessary puncture in the paper. The branches *e e* are attached to the bars *c c*, with a joint which admits of their being folded backwards over the instrument when not in use, and for packing in its case. The center of the instrument is represented by the intersection of two lines drawn at right angles to each other on a piece of plate glass, which enables the person using it to place it so that the center, or intersection of the cross lines, may coincide with any given point on the plan. If the instrument is in correct order, a line connecting the fine pricking points with each other would pass through the center of the instrument, as denoted by the before-mentioned intersection of the cross-lines upon the glass, which, it may be observed, are drawn so nearly level with the under surface of the instrument as to do away with any serious amount of parallax, when setting the instrument over a point from which any angular lines are intended to be drawn. In using this instrument the ver

nier should first be set to zero (or the division marked 360) on the divided limb, and then placed on the paper, so that the two fine steel points may be on the given line (from whence other and angular lines are to be drawn), and the center of the instrument coincide with the given angular point on such line. This done, press the protractor gently down, which will fix it in position by means of very fine points on the under side. It is now ready to lay off the given angle, or any number of angles that may be required, which is done by turning the pinion *d* till the opposite vernier reads the required angle. Then press downwards the branches *e e*, which will cause the points to make punctures in the paper at opposite sides of the circle; which being afterwards connected, the line will pass through the given angular point, if the instrument was first correctly set. In this manner, at one setting of the instrument, a great number of angles, or a complete circular protractor, may be laid off from the same point.

THE T SQUARE AND SEMICIRCULAR PROTRACTOR.

We cannot speak too highly of a method by which a traverse can be most expeditiously as well as accurately plotted,

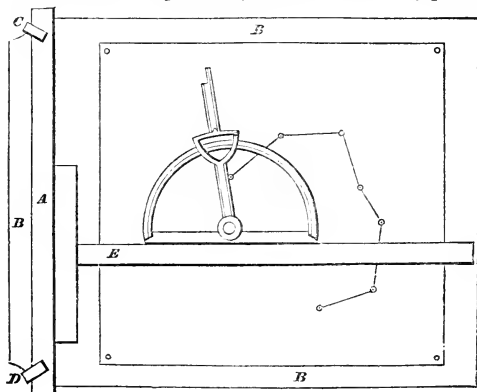

by means of the T square and semicircular protractor, the manner of using which is thus described by Mr. Howlett, chief draughtsman, Royal Ordnance Office, in vol. i of Papers

on Subjects connected with the Duties of the Royal Engineers:—

“As, when away from home, it seldom happens that the surveyor can obtain a good drawing board, or even a table with a good straight edge, I fix a flat ruler, *A*, to the table *B B B*, by means of a pair of clamps, *C D*, and against this ruler I work the pattern square *E*, one side of which has the stock flush with the blade; or, if a straight-edged board be at hand, then the square may be turned over, and used against that edge instead of the ruler *A*. Here, then, is the most perfect kind of parallel ruler that art can produce, capable of carrying the protractor over the whole of a sheet of plotting paper of any size, and may be used upon a table of any form. It is convenient to suppose the north on the left hand, and the upper edge of the blade to represent the meridian of the station.

“This protractor is held in the hand while the vernier is set, which is an immense comfort to the sight; and it will be seen that, as both sides of the arm are parallel with the zero and center, the angle may be drawn on the paper against either side, as the light or other circumstances may render desirable.”

From this description and a mere glance at the engraving, it is clear that angles taken with the theodolite can be transferred to the plot as accurately as the protractor can be set, namely, to a single minute, and that, too, in a rapid and pleasant manner.

Another most admirable and expeditious method of plotting, especially useful when it is a principal point to obtain the area of an estate or parish, &c., is to procure or form a table of northings, southings, eastings, and westings*, for all angles made with a meridian line, and for all distances from 1 to 100. These distances may be either links, feet, chains, or estimated in any denomination whatever, and the corresponding northings, southings, eastings, and westings will be in the same denomination. This table is in fact nothing more than the products of the sines and cosines of the angles, made with the meridian line, multiplied by the several distances, and the following is the method of using it. Take out from this table the northings, southings, eastings, and westings made on each of the lines of the survey, the line from which the angles have been measured being for this purpose assumed as the meridian, no matter in what direction it may lie, and place them in a table, which we may call a traverse table, in four separate columns, being the third, fourth, fifth, and sixth columns of the table†, headed

* This table is the same as the table given in books on navigation, and then called a table of latitude and departure.

† The first and second columns of the traverse table contain the courses and distances.

N., S., E., and W. respectively. Add up these several columns, and, if the work is so far correct, the sum of the northings will equal the sum of the southings, and the sum of the eastings will equal the sum of the westings. Then in two additional columns enter the whole quantities of northing and easting, made at the termination of each of the several bounding lines of the survey; which quantities will be determined by putting zero for the greatest southing, and adding or subtracting the northing or southing made on each particular line to or from the whole quantity of northing made at the beginning of this line, or at the termination of the preceding line; and again, by putting zero for the greatest westing, and adding or subtracting the easting or westing made on each line to or from the whole quantity of easting at the beginning of the line.

This preparatory table having been formed, the plot may be laid down with great ease and accuracy by means of a plotting scale, formed of two ivory graduated rules, one of which, *nn*, represents the assumed meridian along which the northings

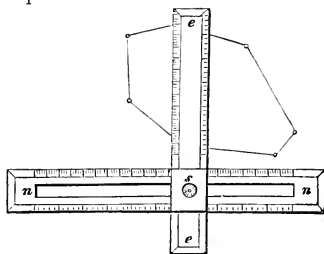

are to be measured, and the other, *ee*, represents the east and west line, and serves to set off the eastings. The rule, *nn*, is perforated throughout nearly its whole length with a dovetail groove, receiving an accurately fitted sliding piece, to which the rule, *ee*, is fixed

by the screw *s*, so as to slide along, and always have its edges at right angles to the edges of the rule *nn*. The rule, *nn*, is to be placed on the paper with its zero division opposite that point of the line assumed as a meridian, at which the plotting is to be commenced, and with its edges parallel to this line, and at such distance from it, that the zero division on the rule, *ee*, may be upon the assumed meridian. The rule, *nn*, is then to be fixed by placing weights upon its extremities, or by clamps. The scale, *ee*, being now slid along till either of its edges coincides with the divisions upon the scale, *nn*, answering to the whole quantities of northing at the termination of each line of the survey, the divisions upon the scale, *ee*, answering to the

1 Courses.	2 Dist- ances.	3 North- ings.	4 South- ings.	5 East- ings.	6 West- ings.	7 Total North- ings.		8 Total East- ings.		9 Sums of Total North- ings.		10 Sums of Total East- ings.		11 East Pro- ducts.	12 West Pro- ducts.	13 North Pro- ducts.	14 South Pro- ducts.
						ch.	lin.	ch.	lin.	ch.	lin.	ch.	lin.	acres.	acres.	acres.	acres.
N. 31° 20' E.	0 00	13 76	0 84	20 6	97	19-14980	...	6-04996	64-66288	...
N. 87 15 E.	10 16	8 68	...	5 29	...	22 44	6 13 36	32 21	48	41-78504	...	-94512	20-87226
S. 14 00 E.	9 23	0 44	...	9 22	...	22 88	15 35 45	30 32	31	6-32730	33-88470
S. 12 25 W.	6 66	...	6 46	1 61	...	16 42	16 96 39	10 31	55	5-23770	9-90592
S. 64 10 W.	11 00	...	10 74	...	2 37	5 68	14 59 22	68 17	44	6-66832	...	83505	...
N. 44 17 W.	13 4	...	5 68	...	11 74	0 00	2 85 5	2 93	2 85	-84091	...	-90972	...
N. 4 28 E.	4 9	2 93	2 87	2 93	0 90	2 93	0 84	13 75	0 84	16 69	0 84	1-40196
						22 88	22 88	16 96	16 98	68-66410	12-74693	8-73985	64-66288	8-73985
						22 88	22 88	16 96	16 98	12-74693	55-91717
												4) 111-84020 Acres 27-96005 4					
												Roods 3-84020 40					
												Perches 37-60800					

whole quantities of casting, will give the terminations of these lines, which, being pricked off, have only afterwards to be joined, and the plot will be completed.

To compute the Area of the Plot.—Rule six additional columns. In the first of these, or ninth column of the traverse table, set the sums of the total northings, and in the tenth, the sums of the total eastings at the beginning and end of each line in the survey, which sums will be found by adding together each pair of succeeding numbers in the two preceding columns. In the eleventh column set the products of the eastings made on the respective lines of the survey, found in the fifth column, multiplied by the corresponding sums of the total northings in the ninth column; and in the twelfth column set the products of the westings found in the sixth column, and the corresponding sums of the total northings in the ninth column. Sum up the eleventh and twelfth columns, and the difference of the totals thus found will be twice the area of the plot. Again in the thirteenth and fourteenth columns set the products of the northings and southings in the third and fourth columns, multiplied by the corresponding sums of the total eastings in the tenth column, and the difference of the sums of the thirteenth and fourteenth columns will again be twice the area of the plot, and, if agreeing nearly with the double area before found, shows the calculations to have been correctly performed. (We give an example in the opposite page.)

The near agreement of the sums of the third and fourth, and of the fifth and sixth columns is a test of the accuracy of the survey; in columns 7 and 8 we have the distances to be set off by the plotting scale; in column 9 we have the multipliers by which the east and west products in columns 11 and 12 are found; and in column 10 we have the multipliers for finding the north and south products in columns 13 and 14. The difference of the sums of the eleventh and twelfth columns gives double the area, the difference of the sums of the thirteenth and fourteenth gives again double the area, and, taking the mean of these results, by adding them together and dividing by 4, we obtain the area most probably to within a quarter of a perch, since the two double areas differ by less than a perch.

THE STATION POINTER.

When the principal features of a country have been laid down by the methods already pointed out, the details may be

put in with great rapidity by means of the instrument which we are now about to describe.

A A, *B B*, *C C*, are three arms moveable about a common center, *o*, and carrying three fine wires stretched quite tight, the prolongation of which would pass exactly through the center, *o*. The arms, *B B*, and *C C*, carry each a graduated arc, *b b*, and *c c*; and the arm *A A* carries two verniers, *a*, *a'*, adapted to the graduated arcs, *b b*, and *c c*, respectively

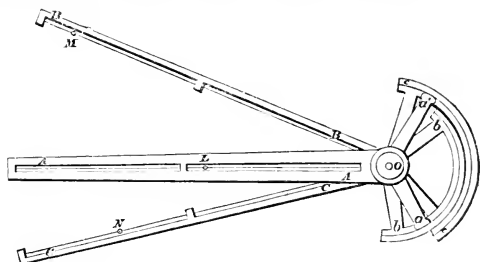

The angles $L O M$, and $L O N$, subtended, at one of the points which we wish to put in, by *L*, *M*, and *N*, three of the principal points of the survey already laid down, having been observed by means of the prismatic compass, or pocket sextant, the arms of the station pointer are opened out till the verniers point out these angles upon the graduated limbs, *b b*, and *c c*, respectively. The station pointer being then placed upon the paper, and moved about till the fine wires pass exactly over the stations *L*, *M*, *N*, as marked already upon the plot, the center will be exactly over the point to be filled in, and its place is to be marked by passing a pricking point through a small opening, which is made at the center to serve this purpose.

PART IV.—ON ASTRONOMICAL INSTRUMENTS.

THE space which we have occupied with the former parts of this work will compel us to be more brief than we had contemplated in the description of the Astronomical Instruments. We shall, therefore, confine our attention more particularly to Hadley's Sextant;

Troughton's Reflecting Circle ;
 The Transit Instrument ;
 The Collimator ;
 Altitude and Azimuth Instruments ;
 with some brief remarks upon other instruments, used for
 astronomical purposes.

HADLEY'S SEXTANT.

This instrument differs from the pocket sextant, already described, in its appearance, from the absence of the box in which the pocket sextant is fixed, in its size, varying usually from 4 inches to 6 inches radius, and in its requiring and admitting of more perfect and minute adjustment.

LL is the graduated limb of the instrument, graduated from 0° to 140° at every $10'$ or $20'$, according to the size of the instrument, and subdivided by the vernier, *v*, to $10''$ or $20''$, thus enabling us to read off angles by estimation, to $5''$. The limb is also graduated through a small space, called the arc of excess, on the other side of the zero point. *T* is the tangent screw for giving a slow motion to the index bar, after it has been clamped by a screw at the back of the instrument, not shown in the figure. *M* is a microscope, attached to the index bar by an arm moveable round the center, *N*, so as to command a view of the vernier throughout its entire length.

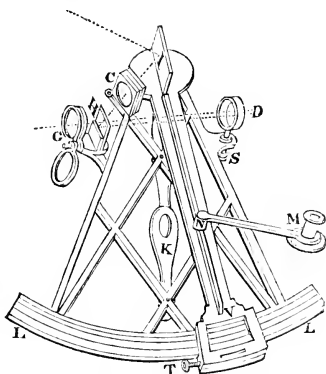

I is the index glass, or first reflector, attached to and moving with the index bar ; and *H* is the horizon glass, having its lower half silvered to form the second reflector, and its upper half transparent. Four dark glasses are placed at *c*, any one or more of which can be turned down between the index glass

and horizon glass to moderate the intensity of the light from any very bright object viewed by reflection; and at *G* are three dark glasses, any one or more of which can be turned up to moderate the intensity of the light from any bright object, viewed directly through the transparent part of the horizon glass. *D* is a ring for carrying the telescope, attached to a stem *s*, called the up and down piece, which can be raised or lowered by means of a milled-headed screw. The use of this up and down piece is to raise or lower the telescope, till the objects seen directly and by reflection appear of the same brightness. *K* is the handle by which the instrument is held.

In selecting an instrument care must be taken that all the joints of the frame are close, without the least opening or looseness, and that all the screws act well, and remain steady, while the instrument is shaken by being carried from place to place. All the divisions on the limb and vernier, when viewed through the microscope, must appear exceedingly fine and distinct, and the inlaid plates, upon which the divisions are marked, must be perfectly level with the surface of the instrument. The index, or zero, of the vernier, should also be brought into exact coincidence successively with each division of the limb, till the last division upon the vernier reaches the last division upon the limb; and, if the last division of the vernier do not in each case also exactly coincide with a division upon the limb, the instrument is badly graduated, and must be rejected. All the glass used in the instrument should be of the best quality, and the glasses of the reflectors should each have their faces ground and polished perfectly parallel to each other, to avoid refraction. Look, therefore, into each reflector, separately, in a very oblique direction, and observe the image of some distant object; and if the image appears clear and distinct in every part of the reflector, the glass is of good quality; but if the image appears notched, or drawn with small lines, the glass is veiny, and must be rejected. Again, if the image appears singly, and well defined about the edges, the two surfaces of the glass are truly parallel; but if the edge of the image appears misty, or separated like two images, the two surfaces are inclined to one another. The examination will be more perfect, if the image be examined with a small telescope.

A plain tube and two telescopes, one showing objects inverted, and the other erect, are usually supplied with the sextant. The manner of testing the telescopes has already been explained in the part of the work devoted to optical in-

struments. A dark glass is also supplied to fit on to the eye-end of the telescope, and a key for turning the adjusting screws.

To examine the Error arising from the Imperfection of the Dark Glasses.—Fit the dark glass to the eye-end of the telescope, and, all the shades being removed, bring the reflected image of the sun into contact with his image seen directly through the unsilvered part of the horizon glass. Then remove the dark glass from the eye-end of the telescope, and, setting up first each shade separately, and then their various combinations, if the two images do not in any case remain in contact, the angle through which the index must be moved to restore the contact, is the error of the dark glass, or combination of dark glasses, used in the observation, and which error should be recorded for each glass and each combination of the glasses.

The adjustments of the instrument consist in setting the horizon glass perpendicular to the plane of the instrument, and in setting the line of collimation of the telescope parallel to the plane of the instrument.

To adjust the Horizon Glass.—While looking steadily at any convenient object, sweep the index slowly along the limb, and, if the reflected image do not pass exactly over the direct image, but one projects laterally beyond the other, then the reflectors are not both perpendicular to the face of the limb. Now the index glass is fixed in its place by the maker, and generally remains perpendicular to the plane of the instrument, and, if it be correctly so, the horizon glass is adjusted by turning a small screw at the bottom of the frame in which it is set, till the reflected image passes exactly over the direct image.

To examine if the Index Glass be perpendicular to the Plane of the Instrument.—Bring the vernier to indicate about 45° , and look obliquely into this mirror, so as to view the sharp edge of the limb of the instrument by direct vision to the right hand, and by reflection to the left. If, then, the edge and its image appear as one continued arc of a circle, the index glass is correctly perpendicular to the plane of the instrument; but if the arc appears broken, the instrument must be sent to the maker to have the index glass adjusted.

To adjust the Line of Collimation.—1. Fix the telescope in its place and turn the eye-tube round, that the wires in the focus of the eye-glass may be parallel to the plane of the instrument. 2. Move the index till two objects, as the sun and moon, or the moon and a star, more than 90° distant from each other, are brought into contact at the wire of the dia-

phragm, which is nearest the plane of the instrument. 3. Now fix the index, and altering slightly the position of the instrument, bring the objects to appear on the other wire; and, if the contact still remain perfect, the line of collimation is in correct adjustment. If, however, the two objects appear to separate at the wire that is further from the plane of the instrument, the object-end of the telescope inclines towards the plane of the instrument; but, if they overlap, then the object-end of the telescope declines from the plane of the instrument. In either case the correct adjustment is to be obtained by means of the two screws, which fasten to the up and down piece the collar holding the telescope, tightening one screw and turning back the other, till, after a few trials, the contact remains perfect at both wires.

The instrument having been found by the preceding methods to be in perfect adjustment, set the index to zero, and if the direct and reflected images of any object do not perfectly coincide, the arc, through which the index has to be moved to bring them into perfect coincidence, constitutes what is called the index error, which must be applied to all observed angles as a constant correction.

To determine the Index Error.—The most approved method is to measure the sun's diameter, both on the arc of the instrument, properly so called, to the left of the zero of the limb, and on the arc of excess to the right of the zero of the limb. For this purpose, firstly, clamp the index at about $30'$ to the left of zero, and, looking at the sun, bring the reflected image of his upper limb into contact with the direct image of his lower limb, by turning the tangent screw, and set down the minutes and seconds denoted by the vernier; secondly, clamp the index at about $30'$ to the right of zero, on the arc of excess, and, looking at the sun, bring the reflected image of his lower limb into contact with the direct image of his upper limb, by turning the tangent screw, and set down the minutes and seconds denoted by the vernier underneath the reading before set down. Then half the sum of these two readings will be the correct diameter of the sun, and *half their difference will be the index error.* When the reading on the arc of excess is the greater of the two, the index error, thus found, must be added to all the readings of the instrument; and when the reading on the arc of excess is the less, the index error must be subtracted in all cases. To obtain the index error with the greatest accuracy, it is best to repeat the above operation several times, obtaining several readings on the arc of the instrument, and the same number on the arc of excess; and

the difference of the sums of the readings in the two cases, divided by the whole number of readings, will be the index error; while the sum of all the readings, divided by their number, will be the sun's diameter.

EXAMPLE.

Readings on the Arc of Instrument.	Readings on the Arc of Excess.	
35	29 25	
35 5	29 35	
35 10	29 20	
105 15	88 20	
88 20	105 15	
No. of readings 6) 16 55	Difference. 6) 193 35	Sum.
2 49	32 15.8	Sun's diameter.

The readings on the arc of excess being less than those on the arc of the instrument, the index error, $2' 49''$, is to be subtracted from all the readings of the instrument.

NOTE.—In taking off the readings on the arc of excess, the vernier must be read backwards; that is, the division read off on the limb, being the division next to the left of the zero of the vernier, the divisions of the vernier to be added must be reckoned from the other end of the vernier to the division coinciding with a division upon the limb; or the reading of the vernier forwards, according to the usual method, may be subtracted from $10'$, the limb being divided to $10'$, and the remainder added to the reading of the division upon the limb next to the left of the zero of the vernier, as before.

The manner of observing with the sextant has been already explained, when treating of the pocket sextant (p. 120).

TROUGHTON'S REFLECTING CIRCLE.

In this instrument, which is the same in principle as the sextant, the limb is a complete circle, I. L. L. It has three verniers, v v v, one of which is furnished with the clamp and tangent screw, s s, for regulating the contacts; and the verniers are read by a magnifier, M, which may be applied successively to all the verniers. In the middle of the frame, and attached to it by a broad base or flanch, is a hollow center, upwards of two inches long, in which an axis revolves. The triple vernier bar, I I I, is attached at one end of the axis, and the index glass at the other, so that both turn together, but on opposite sides of the instrument. A secondary frame, B B, carries the telescope, T, the horizon glass, and the dark glasses. H H are two handles, one of them bent, and passing round to the center of the instrument on the other side; and there is a third handle,

which can be screwed on perpendicular to the plane of the instrument, either into the handle at *c*, or upon the other side of the instrument, at its center. The adjustments and manner of observing with the instrument are explained by the inventor, Mr. Troughton, as follows:—

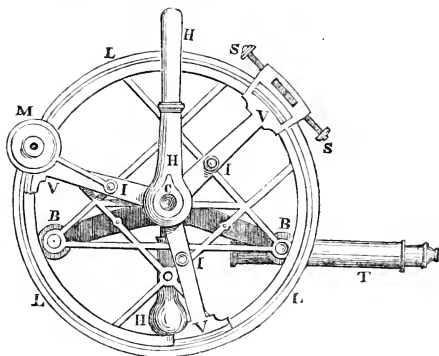

Directions for observing with Troughton's Reflecting Circle.—"Prepare the instrument for observation by screwing the telescope into its place, adjusting the drawer to focus, and the wires parallel to the plane, exactly as you do with a sextant: also set the index forwards to the rough distance of the sun and moon, or moon and star; and, holding the circle by the short handle, direct the telescope to the fainter object, and make the contact in the usual way. Now read off the degree, minute, and second, by that branch of the index to which the tangent screw is attached; also, the minute and second shown by the other two branches; these give the distance taken on three different sextants; but as yet it is only to be considered as half an observation: what remains to be done, is to complete the whole circle, by measuring that angle on the other three sextants. Therefore set the index backwards nearly to the same distance, and reverse the plane of the instrument, by holding it by the opposite handle, and make the contact as above, and read off as before what is shown on the three several branches of the index. The mean of all six is the true apparent distance, corresponding to the mean of the two times at which the observations were made.

"When the objects are seen very distinctly, so that no doubt whatever remains about the contact in both sights being perfect, the above may safely be relied on as a complete set; but if, from the haziness of the air, too much motion, or any other causes, the observations have been rendered doubtful, it will be advisable to make more: and if, at such times, so many readings should be deemed troublesome, six observations, and six readings, may be conducted in the manner following:—Take three successive sights forwards, exactly as is done with a sextant; only take care to read them off on different

branches of the index. Also make three observations backwards, using the same caution; a mean of these will be the distance required. When the number of sights taken forwards and backwards are unequal, a mean between the means of those taken backwards and those taken forwards, will be the true angle.

“It need hardly be mentioned, that the shades, or dark glasses, apply like those of a sextant, for making the object nearly of the same brightness; but it must be insisted on, that the telescope should, on every occasion, be raised or lowered, by its proper screw, for making them perfectly so.”

The foregoing instructions for taking distances apply equally for taking altitudes by the sea or artificial horizon, they being no more than distances taken in a vertical plane. Meridian altitudes cannot, however, be taken both backwards and forwards the same day, because there is not time; all, therefore, that can be done is, to observe the altitude one way, and use the index error; but, even here, you have a mean of that altitude, and this error taken on three different sextants. Both at sea and land, where the observer is stationary, the meridian altitude should be observed forwards one day, and backwards the next, and so on alternately from day to day; the mean of latitudes, deduced severally from such observations, will be the true latitude; but in these there should be no application of index error, for that being constant, the result would in some measure be vitiated thereby.

“When both the reflected and direct images require to be darkened, as is the case when the sun’s diameter is measured, and when his altitude is taken with an artificial horizon, the attached dark glasses ought not to be used: instead of them, those which apply to the eye-end of the telescope will answer much better; the former having their errors magnified by the power of the telescope, will, in proportion to this power, and those errors, be less distinct than the latter.

“In taking distances, when the position does not vary from the vertical above thirty or forty degrees, the handles which are attached to the circle are generally most conveniently used; but in those which incline more to the horizontal, that handle which screws into a cock on one side, and into the crooked handle on the other, will be found more applicable.

“When the crooked handle happens to be in the way of reading one of the branches of the index, it must be removed, for the time, by taking out the finger screw, which fastens it to the body of the circle.

“If it should happen that two of the readings agree with each other very well, and the third differs from them, the discordant one must not on any account be omitted, but a fair mean must always be taken.

“It should be stated, that when the angle is about thirty degrees, neither the distance of the sun and moon, nor an altitude of the sun, with the sea horizon, can be taken backwards; because the dark glasses at that angle prevent the reflected rays of light from falling on the index glass; whence it becomes necessary, when the angle to be taken is quite unknown, to observe forwards first, where the whole range is without interruption; whereas in that backwards you will lose sight of the reflected image about that angle. But in such distances, where the sun is out of the question, and when his

altitude is taken with an artificial horizon (the shade being applied to the end of the telescope), that angle may be measured nearly as well as any other; for the rays incident on the index glass will pass through the transparent half of the horizon glass without much diminution of their brightness.

“The advantages of this instrument, when compared with the sextant, are chiefly these: the observations for finding the index error are rendered useless, all knowledge of that being put out of the question, by observing both forwards and backwards. By the same means the errors of the dark glasses are also corrected; for if they increase the angle one way, they must diminish it the other way by the same quantity. This also perfectly corrects the errors of the horizon glass, and those of the index glass very nearly. But what is of still more consequence, the error of the center is perfectly corrected by reading the three branches of the index; while this property, combined with that of observing both ways, probably reduces the errors of dividing to one-sixth part of their simple value. Moreover, angles may be measured as far as one hundred and fifty degrees, consequently the sun’s double altitude may be observed when his distance from the zenith is not less than fifteen degrees; at which altitude the head of the observer begins to intercept the rays of light incident on the artificial horizon; and, of course, if a greater angle could be measured, it would be of no use in this respect.

“This instrument, in common with the sextant, requires three adjustments: first, the index glass perpendicular to the plane of the circle. This being done by the maker, and not liable to alter, has no direct means applied to the purpose; it is known to be right when, by looking into the index glass, you see that part of the limb which is next you reflected in contact with the opposite side of the limb as one continued arc of a circle: on the contrary, when the arc appears broken where the reflected and direct parts of the limb meet, it is a proof that it wants to be rectified. The second is, to make the horizontal glass perpendicular. This is performed by a capstan screw, at the lower end of the frame of that glass; and is known to be right when by a sweep of the index the reflected image of any object will pass exactly over, or cover the image of that object seen directly. The third adjustment is for making the line of collimation parallel to the plane of the circle. This is performed by two small screws, which also fasten the collar into which the telescope screws to the upright stem on which it is mounted; this is known to be right when the sun and moon, having a distance of one hundred and thirty degrees, or more, their limbs are brought in contact, just at the outside of that wire which is next to the circle, and then examining if it be just the same at the outside of the other wire: its being so is the proof of adjustment.”

Another instrument of Troughton’s construction upon the principle of the sextant is the dip sector, for measuring the dip of the horizon. Any person who is thoroughly acquainted with the sextant will find no difficulty in using it, after a few words of explanation from the maker.

THE TRANSIT INSTRUMENT.

The reflecting instruments, which we have just described, from their portability and the promptitude and facility with which they may be used in all situations, and upon all occasions, are most useful instruments to the surveyor. The sextant or reflecting circle, with an artificial horizon, and a

good chronometer, forms, in fact, a complete observatory, with which the latitudes and longitudes of places may be determined to a great degree of accuracy; while to the navigator a reflecting instrument is indispensable; all other instruments requiring to be supported upon a stand perfectly at rest*, while the sextant and similar instruments are held in the hand, and perform their duty well on the deck of a rolling ship. In permanent observations, however, the capital angular instruments are placed permanently in the plane of the meridian, and the measurements sought for by their aid are the exact times at which the observed objects pass the meridian, and their angular altitudes or zenith distances, when upon the meridian. The instrument with which the first of these measurements are obtained is called a *transit instrument*, *transit telescope*, or merely a *transit*. Transits of portable dimensions, besides their use in small or temporary observatories, are also found serviceable to the surveyor, for determining, with the greatest possible accuracy, the true north point, and thence setting out a line in any required direction; and to the scientific traveller, for determining the longitude of any place from astronomical observations, and for adjusting his time-keepers with greater accuracy than can be obtained by his sextant or reflecting circle. The annexed figure represents a portable transit.

T T is a telescope formed of two parts, connected by a spherical center-piece, into which are fitted the larger ends of two cones, the common axis of which is placed at right angles to the axis of the telescope, to serve as the horizontal axis of the instrument. The two small ends of these cones are ground into two perfectly equal cylinders, called *pivots*. The pivots rest upon angular bearings or *Ys*. The *Ys* are supported upon the standards E and W, of which E may be called the eastern, and W the western standard; and one of the *Ys* is fixed in a horizontal groove, on the western standard, so that, by means of the screw S, one end of the axis may be pushed a little forwards or backwards, and a small motion in azimuth be thus communicated to the telescope†. The standards, E

* In observatories the instruments are supported by stone walls, or pillars, which pass below the floors, without touching them, or any part of the building, and are consequently independent of any tremor, communicated to the floor or walls of the buildings. It was considered that the passage of a railway through Greenwich Park would impair the observations at the Royal Observatory, by communicating a tremor to the ground.

† The large transits in permanent observations have their *Ys* placed in two dove-tailed grooves, one horizontal, and the other vertical. By means

and w , are fixed by screws upon a brass circle, $o o$, and steadied by oblique braces, $B B$, which spring from the cross-piece, c .

On one end of the axis is fixed, so as to revolve with the axis, a vertical circle, $v v$; and a double index bar, furnished

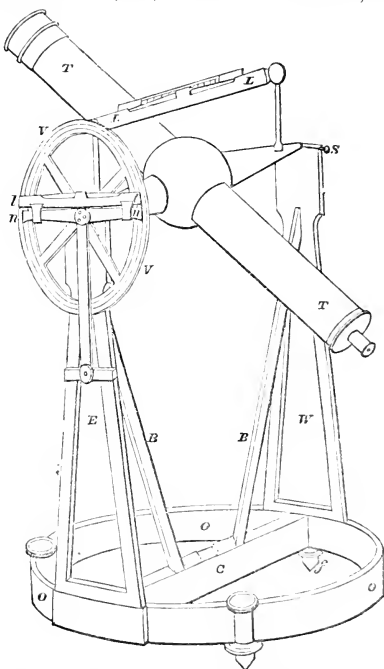

with a spirit level, $l l$, to set it horizontal, carries two verniers, $n n$, adapted to the vertical circle, and showing the angle of elevation of the telescope. The index-bar is fixed in its position by the clamping screw, c , and can be fixed upon of the latter one end of the axis may be raised or depressed; but in the portable transit the same object is attained by turning one of the foot screws upon which the entire instrument rests.

either the eastern or western standard, at pleasure, while the telescope, with its attached circle, can also be lifted out of, and have its position reversed in, the Ys. The pivot, which does not carry the vertical circle, is pierced, and allows the light from a lamp to fall upon a plane speculum, fixed, in the spherical center piece, on the axis of the telescope, and inclined to this axis at an angle of 45° . The light is thus thrown directly down the telescope, and illuminates the wires of the diaphragm, placed in the principal focus of the telescope. Of these wires, one is horizontal; and a vertical wire, intersecting it in the center of the field of view, gives, by its intersection with it, the collimating point. There are, then, other vertical wires arranged in pairs equidistant from the central vertical wires, so that we have either three, or five, or seven vertical wires, the most common number being five. The lamp has a contrivance for regulating the quantity of light thrown into the telescope, by turning a screw, so that the light from a small star may not be overpowered by the superior light of the lamp.

The requisites of a good instrument, are—1stly, that the telescope be of the best quality, which is to be tested by the methods already given (pp. 86–88); 2ndly, that the feet screws act well and remain steady; 3rdly, that all the screws, by which the instrument is put together, are turned home, and remain so, after the instrument has been shaken by carriage; 4thly, that the length of the axis be just sufficient to reach from one Y to the other, without either friction or liberty; 5thly, that the lamp be held so as not to require adjustment for position; 6thly, that the screws of adjustment of the diaphragm, and Ys, be competent to give security of position to the parts adjusted by them; 7thly, that the metallic parts be free from flaws in casting, and that the pivots be formed of hard bell metal and incapable of rusting.

The principal adjustments of the transit are three:—

- 1st. To make the axis on which the telescope moves horizontal.
- 2nd. To make the line of collimation move in a great vertical circle, by setting it perpendicular to the horizontal axis.
- 3rd. To make it move in that vertical circle, which is the meridian.

To make the Axis Horizontal.—Apply to the pivots the large level, LL, which is supplied with the instrument for this purpose, and is either constructed to stand upon the pivots, in which case it is called a striding level, or of the form shown at page 96, in which case it is suspended from the pivots, and is called a hanging level. Bring the air bubble

to the center of its run, by turning the foot screw, *f*. Turn the level end for end, and, if the air bubble retains its position, the axis is horizontal, but, if not, it must be brought back half by the foot screw, *f*, and the other half by turning the small screw at one end of the level. Repeat the operation till the bubble retains the same position in both positions of the level, and the axis will be horizontal.

To adjust the Line of Collimation in Azimuth.—Direct the telescope to some distant, small, and well-defined object, and bisect it by one extremity of the middle vertical wire, giving the telescope the azimuthal motion necessary for this purpose by turning the screw *s*. By elevating or depressing the telescope, examine whether the object is bisected by every part of the middle vertical wire; and if not, loosen the screws which hold the eye-end of the telescope in its place, and turn the end round very carefully till the error is moved. Lift the transit off the *Y*s, and reverse it, so that the end of the axis, which was upon the eastern *Y*, may now be upon the western, and *vice versa*; and, if the object is still bisected by the central vertical wire, the collimation in azimuth is perfect; but, if not, move the center of the cross wires half way towards the object by turning the small screws which hold the diaphragm, and, if this half distance has been correctly estimated, the adjustment will be accomplished. Again, bisect the object by the center of the cross wires by turning the azimuthal screw *s*, and repeat the operation, till the object is bisected by the center of the cross wires in both positions of the instrument, and the adjustment will be known to be perfect*.

To adjust the Transit to the Meridian.—The line of collimation by reason of the previous adjustment describes a vertical circle, and, therefore, bisects the zenith, which is one point in the meridian. If, then, we can make it also bisect another point in the meridian, it will move entirely in the meridian. Compute from the tables in the Nautical Almanack, the time of *Polaris* coming to the meridian, and at the computed time bisect the star by the middle vertical wire, and the transit will be very nearly adjusted to the meridian.

To make the great vertical circle described by the line of collimation more nearly coincident with the meridian, let the intervals between the successive passages of *Polaris* across

* The horizontal motion given to the *Y*, by the azimuthal screw *s*, forms, evidently, no part of the adjustment for collimation, but only enables us to examine if the adjustment has been made with sufficient exactness.

the meridian be observed, as indicated by the instrument. Then, if the interval between the inferior and superior passage be equal to the interval between the superior and inferior, the adjustment to the meridian is perfect; but if the interval between the inferior and superior passage be less than the interval between the superior and inferior, the circle described by the line of collimation deviates to the eastward of the true meridian, from the zenith to the north point of the horizon, and to the westward, from the zenith to the south point of the horizon; while if the interval between the inferior and superior passage be the greater, the deviation is in the contrary directions.

Let δ be the observed difference of the intervals from twelve hours, or half the difference between the two intervals in seconds, π the polar distance of the star Polaris, and L the latitude of the place, then, z representing the deviation from the meridian in time, the value of z will be given by the logarithmic formula,

$$\log. z = \log. \frac{\delta}{2} + \log. \sec. L + \log. \tan. \pi - 20.$$

EXAMPLE.

Place of observation, Cambridge, latitude $52^{\circ} 12' 36''$.

Polar distance of Polaris, $1^{\circ} 39' 25''.05$.

Difference of intervals from 12 hours $7^m 22^s = 442^s$.

$\frac{\delta}{2} = 221$	log.	=	2.3443923
$L = 52^{\circ} 12' 36''$	log. sec.	=	10.2127030
$\pi = 1^{\circ} 39' 25''.05$	log. tan.	=	8.4513064

$z = 10^s.195$	log.	=	21.0084017

To determine the value of a revolution of the azimuthal screw, s , the time* of passage of an equatorial star across the middle vertical wire must be noted one day; and then, turning the screw, s , once round, the time of passage* must be noted again; and the difference of these times will be the value in time of a revolution of the screw. Suppose the difference thus observed to amount to two seconds, then the value of one complete revolution of the screw, s , is two seconds, and the value of the motion of the adjusting screw being thus obtained, must be reduced to the horizon, by increasing it in the ratio of cosine of latitude to radius, and may then be applied to correct the error of deviation as found above.

* The time here spoken of, and throughout the description of this instrument, unless otherwise expressly stated, is sidereal, and not mean time.

A second method, founded on the same principles as the preceding, consists in observing the pole star, and another star, which crosses the meridian near the zenith of the place of observation. The time of passage of such a star, Capella, for instance, when near its superior transit, across the middle wire of the telescope, will differ but very little from the time of passing the true meridian, if the deviation of the instrument from the meridian be but small. Assume the two times to agree exactly, and the difference between the times of superior transit of Capella and Polaris will be the difference of the observed right ascensions of these two stars. From this difference subtract the difference of the computed, or catalogued, right ascensions of the two stars, and call the result D ; and the deviation will be given by the formula,

$$\log. z = \log. D + \log. \sin. \pi + \log. \sec. (L + \pi);$$

π being the polar distance of Polaris, and L the latitude of the place of observation. From Capella not having been exactly on the meridian, when on the middle vertical wire, the value of D , as above obtained, is only an approximation to the error of the observed right ascension of Polaris, and the deviation computed from it will be only approximately correct; but, by repeating the operation, the adjustment may be completely perfected.

D is actually the value of the sum of the errors of the observed right ascensions of Capella and Polaris, and hence the value of z will be correctly given, by so considering it, instead of supposing as above, that this error for Capella is zero. The true deviation then is given by the formula,

$$\log. z = \log. D + \log. \sin. \pi + \log. \sin. \pi' + \log. \operatorname{cosec}. (\pi' - \pi) + \log. \sec. L;$$

π' being the polar distance of Capella.

Using this last formula, the method may be applied to Polaris, and any star distant from the pole, or to any two stars differing from each other not less than 40° in declination. If, however, the transit of one star is observed above, and of the other, below the pole, the formula will be

$$\log. z = \log. D + \log. \sin. \pi + \log. \sin. \pi' + \log. \operatorname{cosec}. (\pi' + \pi) + \log. \sec. L.$$

Considerable advantage may be obtained by selecting two stars that differ but little in right ascension, as there is then the less probability of error from a change in the rate of the clock, or in the position of the instrument, on which account such methods are to be preferred in temporary observatories, where the stability of the instrument is not to be depended upon for any length of time.

In all the preceding formulæ, the deviation from the meridian is given in time; but, to convert it into angular measure, if desirable, we have only to multiply by 15, and the seconds of time will be converted into seconds of a degree.

When the instrument is by any of the methods explained above brought into the meridian, a distant mark may be set up in the plane of the meridian, by which the adjustment to the meridian may afterwards be tested.

METHOD OF OBSERVING WITH THE TRANSIT.

The adjustments having been completed, in making observations with the instrument, the instant of a star's passing the middle vertical wire will be the time of the star's transit; but the time of the star's passing all the five wires must be noted, and the mean of the times, taken as the time of transit, will be a more accurate result than the time observed at the middle wire only.

When the sun is the object observed, the time of the center of his disc passing the middle wire is the time of transit; but, as it would be impossible to estimate the center with accuracy, the time of both his limbs coming into contact with each wire in succession is to be noted, and a mean of all these times will be the time of transit required. This mean may be conveniently taken, by writing the observed times of contact of the first and second limbs underneath each other in the reverse order, when the sums of each pair will be nearly equal*.

EXAMPLE.

1826, Sept. 23	^s 20·4	^s 38·7	^h 11	^m 58	^s 57·0	^s 15·5	^s 33·7	☉ 1 Limb.
	42·3	24·0	12	1	5·7	47·2	28·7	☉ 2 Limb.
	2·7	2·7	24	0	2·7	2·7	2·4	The sum = 13·2

The time of either limb passing the center wire is recorded in full, but for the other wires, the seconds only are recorded, as the sums of the several pairs only differ by decimals of a second. Half the sum of the times at the middle gives, then, the correct time of transit as far as the seconds, and the decimals are found by removing the decimal point one place to the left in the sum 13·2, which is equivalent to dividing by 10. Then the time of transit, or mean of observations in the above example, is 12^h 0^m 1^s·32. This example is taken from observations made with a large transit; and, if with a smaller

* This is Dr. Pearson's method.

instrument the sums of the several pairs of observations should differ by more than a second, it will be necessary to take the sums of both figures of the seconds, and the division by 10, performed as above, will give the last figure of the seconds, as well as the decimals.

In taking transits of the moon the luminous edge alone can be observed, from which the time of transit of the center must be deduced by the aid of Lunar tables.

In observing the larger planets, one limb may be observed at the first, third, and fifth wires, and the other at the second and fourth, and the mean of these observations will give the transit of the planet's center.

It will sometimes happen that from the state of weather, or from some other cause, a heavenly body may not have been observed at all the wires; but, if the declination of the body be known, an observation at any one of the wires may be reduced to the central wire, so as to give the time of transit, as deduced from this observation. If an observation be obtained at more than one wire, the mean of the times of passing the center, as deduced from each wire observed, is to be taken as the time of transit. The reduction to the center wire is given by the formula,

$$R = v \operatorname{cosec.} \pi,$$

$$\text{or } \log. R = \log. v + \log. \operatorname{cosec.} \pi;$$

in which R represents the reduction, π the polar distance of the body observed, and v the equatorial interval from the wire, at which the observation has been made, to the central wire. The equatorial intervals for each side wire must, therefore, be carefully observed, and tabulated for the purpose of this reduction. The formula $R = v \operatorname{cosec.} \pi$ is only an approximate value of the reduction, and with large instruments capable of giving results within $0''\cdot05$, a further correction is necessary for bodies within 10° of the pole. The whole reduction in this case is given by the formula,

$$R' = \frac{1}{15} \sin.^{-1} (\operatorname{cosec.} \pi \sin. 15 v).$$

The time of any star's passage from one of the side wires to the center wire being observed, the equatorial interval from that wire to the center is obtained by multiplying the observed interval by the sine of the star's polar distance; and the equatorial intervals being deduced in this manner from a great many stars, the mean of the results may be considered as very correct values of the equatorial intervals required

No star very near the pole should, however, be taken for this purpose.

USE OF THE PORTABLE TRANSIT.

The large transits in permanent observatories are used to obtain, with the greatest possible accuracy, the right ascensions of the heavenly bodies, from which, and the meridian altitudes observed by a mural circle, an instrument consisting of a telescope attached to a large circle, and placed in the plane of the meridian, nearly all the data necessary for every astronomical computation are obtained. For such purposes the small portable transit is not adapted; but it is competent to determine the time to an accuracy of half a second, to determine the longitude by observations of the moon and moon culminating stars, and to determine the latitude by placing it at right angles to the meridian, or in the plane of the prime vertical*.

The transit of the sun's center gives the apparent noon at the place of observation, and the mean time at apparent noon is found by subtracting or adding the equation of time, as found in the Nautical Almanack, to 24 hours†. The difference between the mean time, thus found, and the time of the sun's transit, as shown by a clock or chronometer, is the error of the clock or chronometer for mean time at the place of observation.

The time shown by a sidereal clock when any heavenly body crosses the meridian should coincide with the right ascension of that body, as given in the Nautical Almanack. The difference between the time shown by the sidereal clock, at the transit, and the right ascension of the body, taken from the almanack, will, therefore, be the error of the clock, +, or too fast, when the clock time is greater than the right ascension, —, or too slow, when it is less.

THE PORTABLE ALTITUDE AND AZIMUTH INSTRUMENT.

The bending of an unbraced telescope renders it unfit for the determination of altitudes; but by placing the telescope

* The prime vertical is the great circle which passes through the zenith and the east and west points of the horizon.

† The astronomical day commences at noon, and contains 24 hours, the hours after midnight being called 13, 14, &c., and the day ends at the next noon. The equation of time is given in the Nautical Almanack for apparent noon at the meridian of Greenwich, and the correction to give the equation of time at any other meridian will be found by multiplying the difference for one hour, as given in the almanack, by the longitude of the place, estimated in time.

between two circles braced together, an instrument may be formed capable of observing both the meridian altitudes and times of transit of the heavenly bodies. The increased weight of the instrument, however, must now be prevented from producing flexure in the horizontal axis, and this has been very ingeniously accomplished by Troughton. By mounting the transit and altitude instrument, as Troughton's transit-circle may be called, upon a horizontal plate or circle having an azimuthal motion round a vertical axis, an instrument is formed by which observations may be made either in or out of the meridian. When constructed of a portable size, the altitude and azimuth instrument may also be used in important surveying operations; for, in fact, it may be considered as a rather large theodolite of superior construction.

The altitude and azimuth instrument may be considered as consisting of three parts: 1, the tripod carrying the vertical axis about which the instrument turns; 2, the horizontal revolving plate carrying the vertical pillars, with their appendages; and 3, the vertical circles with the telescope.

The tripod, *AAA*, is supported by three footscrews, by which the vertical axis is brought into adjustment, and carries the lower horizontal plate, which is graduated to show the azimuths or horizontal angles. The vertical axis is a solid metallic cone rising from the center of the tripod to a height about equal to the radius of the horizontal circle.

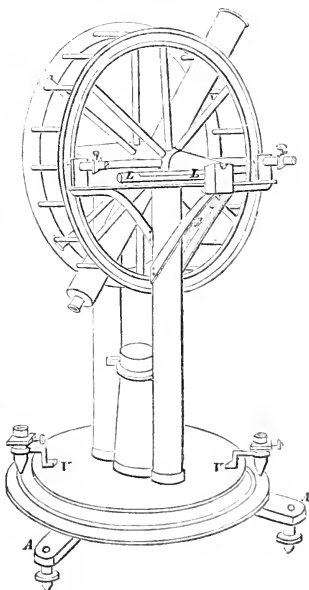

The upper horizontal plate, or horizontal revolving plate, *v v*, carries an index, to point out the graduation, upon the lower horizontal plate, or azimuth circle, which denotes nearly the angle to be read off. The graduations upon the azimuth circle, as well as upon the vertical circle, are subdivided by reading microscopes, the construction and adjustments of which we shall presently explain. The reading microscopes of the azimuth circle are attached to the revolving plate, *v v*, which also carries two upright pillars. From the center of the upper horizontal plate, *v v*, rises a hollow brass cone which just fits over, and moves smoothly upon the solid metallic vertical axis rising from the tripod stand. A horizontal brace connects the two upright pillars with one another and with the top of the hollow brass cone, and keeps the pillars firm and parallel to one another. On the top of each pillar a gibbet piece is fixed, projecting beyond the pillars, and upon the extreme ends of these pieces are carried the *Ys* for supporting the pivots of the horizontal, or transit axis. The *Ys* are each capable of being raised or lowered by turning a milled-headed screw. The top of one of the pillars carries a cross-piece for supporting the two reading microscopes of the vertical circle; and to this cross-piece is attached the level, *L L*, by which the adjustment of the vertical axis is denoted.

The third portion of the instrument consists of the vertical circle and its telescope. This circle consists of two limbs firmly braced together, and preventing any tendency to flexure in the tube of the telescope, by affording it support at the opposite ends of a diameter. One of the limbs only is graduated, and the graduated side is called the face of the instrument, and the clamp and tangent screw, for giving a slow motion to the vertical circle, act upon the ungraduated limb, and are fixed to the vertical pillar on the side of that limb. The horizontal axis which supports the telescope and vertical circle is constructed exactly as the axis of the transit instrument already described; but, as it might press too heavily on the *Ys* from the increased load of the vertical circle, a spiral spring, fixed in the body of each pillar, presses up a friction roller against the conical axis with a force which is nearly a counterpoise to its weight. The adjustment of the horizontal axis is denoted by a striding level, as in the portable transit already described.

ADJUSTMENTS.

Adjustments of the Vertical Axis.—Turn the instrument round till the level, L.L., is over two of the foot-screws, and adjust the level, so that its bubble may retain the same position, when the instrument is turned half round, so that the level is again over the same foot-screws, but in the reverse position. The error at each trial is corrected, as nearly as can be judged, half by the foot-screws, and half by the adjusting screw of the level itself.

Next turn the instrument round 90° in azimuth, so that the level, L.L., may be at right angles to its former positions, and bring the bubble to the same position as before, by turning the third foot-screw. Repeat the whole operation till the result is satisfactory.

Adjustment of the Horizontal Axis.—This adjustment is performed in the same manner, as already described for the transit instrument (p. 147), with the single exception that one end of the axis is to be raised or lowered, if necessary, by the screw acting upon its Y, and not by moving a foot-screw, which would derange the previous adjustment.

Adjustment of the Circle to its Reading Microscopes.—This is performed by raising or lowering both the Ys equally, so as not to derange the previous adjustment, till the microscopes are directed to opposite points in its horizontal diameter.

Adjustment of Collimation in Azimuth.—Instead of taking the axis out of its bearings and turning it end for end, the whole instrument is turned round in azimuth; but in all other respects the method of performing this adjustment is the same as that already described for the transit instrument (p. 148).

Adjustment of Collimation in Altitude.—Point the telescope to a very distant object, or star, and, bisecting it by the cross wires, read off the angle upon the vertical circle denoted by the reading microscopes. Turn the instrument half round in azimuth, and, again bisecting the same object by the cross wires, read off the angle. One of these readings will be an altitude, and the other a zenith distance*, and their sum, therefore, when there is no error of collimation in altitude, will be 90° . If the sum is not 90° , half its difference from 90°

* Both the horizontal and vertical circles are usually divided alike into four quadrants, and each quadrant graduated from 0° to 90° , proceeding in the same direction all round the circles.

will be the error of collimation in altitude, and this error being added to, or subtracted from, the observed angles, according as the sum of the readings is less or greater than 90° , will give the true zenith distance and altitude. The error of collimation in altitude may then be corrected by adjusting the microscopes to read the true zenith distance and altitude, thus found, while the object is bisected by the cross wires of the telescope. The error of collimation of this and other astronomical instruments may also be found, or corrected, by the collimator.

Use of the Altitude and Azimuth Instrument.—In using the altitude and azimuth instrument, for astronomical purposes, double observations should always be made, with the face first to the east, and then to the west, or *vice versá*, or several observations may be made with the face to the east, and as many with the face to the west, and the mean of the results, reduced to the meridian, taken as the true results. The place for a meridian mark may be determined by the methods already explained when describing the transit instrument, or by observing the readings of the azimuthal circle, or noting the times, when any celestial object has equal altitudes. Since the diaphragm of the telescope is furnished not only with the central horizontal wire, but with other horizontal wires at equal distances above and below it, so that there may be altogether either three, or five, or seven horizontal wires, the azimuths and times may be observed, when the object observed is bisected by each of these wires. If a fixed star be the object observed, the mean of the times will give the time of the star's passing the meridian, and the mean of the azimuths will give the reading of the azimuth circle when the star was on the meridian, or the correction to be applied to the readings of the azimuth circle to give the true azimuths. If the sun be the body observed, a correction is necessary on account of the change of his declination, during the intervals between the observations.

The correction for the time, as deduced from a pair of equal altitudes of the sun, is given by the formula,

$$\text{Correction} = \frac{\delta}{720} \times \frac{t}{\sin. 15^\circ \cdot \frac{t}{2}} (\tan. D \times \cos. 15^\circ \cdot \frac{t}{2} - \tan. L.)$$

in which δ represents the variation in the sun's declination from the noon of the day preceding the observations to the noon of the day succeeding;

t represents the interval between the observations expressed in hours and decimals of an hour;

D represents the sun's declination at noon on the day on which the observations are made ;

L represents the latitude of the place.

δ is to be reckoned positive when the sun's declination is increasing, and negative when it is decreasing.

The correction for azimuth is given by the formula,

$$\text{Correction} = \frac{1}{2} (D' - D) \sec. \text{lat. cosec.} \frac{15}{2} (T' - T).$$

in which $D' - D$ represents the change of the sun's declination, } between the
and $T' - T$ represents the interval in time, } observations.

When the sun is advancing towards the North Pole, this correction will carry the middle point towards the west of the approximate south point ; but when he is approaching the South Pole, it will carry the same point towards the east, and must be applied accordingly.

The altitude and azimuth instrument being adapted to observe the heavenly bodies in any part of the visible expanse of the heavens, its powers may be applied at any time to determine the data from which the time, the latitude of the place of observation, or the declination of the body observed, may be at once determined. We subjoin some of the formulæ, adapted to logarithmic computation, connecting the parts of what may be called the *astronomical triangle*, of which the angular points are, the pole, P , the zenith, Z , and the apparent place of the body observed, S .

Let PZ , the colatitude of the place, be represented by λ .

PS , the polar distance of the body observed π .

ZS , the zenith distance of the body observed z .

ZPS , the hour angle from the meridian h .

PZS , the azimuthal angle a .

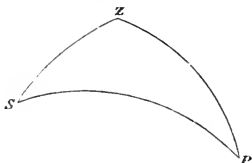

Then we have the following formulæ for determining the time, the latitude, and the declination of the body observed.

FORMULÆ.

No.	GIVEN.	REQUIRED.	AUXILIARY ANGLES.	FORMULÆ.
1	z, π, λ	h	$\tan \frac{1}{2} h = \sqrt{\frac{\sin \frac{1}{2} (z + \pi - \lambda) \cdot \sin \frac{1}{2} (z + \lambda - \pi)}{\sin \frac{1}{2} (z + \pi + \lambda) \cdot \sin \frac{1}{2} (\pi + \lambda - z)}}$
2	π, λ, α	h	$\tan \phi = \frac{\cot \alpha}{\cos \lambda}$	$\cos (h \sim \phi) = \frac{\cot \pi \cos \phi}{\cot \lambda}$
3	z, λ, α	h	$\cot \phi = \frac{\cot z}{\cos \alpha}$	$\cot h = \frac{\cot \alpha \sin (\lambda \sim \phi)}{\sin \phi}$
4	z, π, α	h	$\sin h = \frac{\sin z \sin \alpha}{\sin \pi}$
5	z, π, α	λ	$\tan \phi = \cos \alpha \tan z$	$\cos (\lambda \sim \phi) = \frac{\cos \pi \cos \phi}{\cos z}$
6	z, π, h	λ	$\tan \phi = \cos h \tan \pi$	$\cos (\lambda \sim \phi) = \frac{\cos z \cos \phi}{\cos \pi}$
7	z, α, h	λ	$\cot \phi = \frac{\cot z}{\cos \alpha}$	$\sin (\lambda \sim \phi) = \frac{\cot h \sin \phi}{\cot \alpha}$
8	π, α, h	λ	$\cot \phi = \frac{\cot \pi}{\cos h}$	$\sin (\lambda \sim \phi) = \frac{\cot \alpha \sin \phi}{\cot h}$
9	z, λ, α	π	$\tan \phi = \cos \alpha \tan z$	$\cos \pi = \frac{\cos z \cos (\lambda \sim \phi)}{\cos \phi}$
10	z, λ, h	π	$\tan \phi = \cos h \tan \lambda$	$\cos (\pi \sim \phi) = \frac{\cos z \cos \phi}{\cos \lambda}$
11	z, α, h	π	$\sin \pi = \frac{\sin \alpha \sin z}{\sin h}$
12	λ, α, h	π	$\tan \phi = \frac{\cot \alpha}{\cos \lambda}$	$\cot \pi = \frac{\cot \lambda \cos (h \sim \phi)}{\cos \phi}$

THE READING MICROSCOPE.

The first of the annexed figures represents a longitudinal section of this instrument, and the second represents the

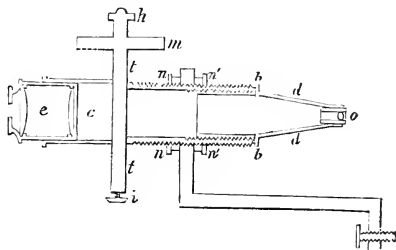

field of view, showing the magnified divisions of the limb of the instrument to which the microscope is applied, and the diaphragm, *dd*, of the microscope, with its comb, *cc*, and cross wires, *ww*. The diaphragm is contained in the box, *tt*, and consists of two parts moving one over the other, the comb, *cc*, which is moved by the screw, *i*, at the bottom of the box, for the purpose of adjustment, and the cross wires, *ww*, and index, *i*, which are moved over the comb and the magnified image of the limb, by turning the milled head, *h*. The micrometer head, *m*, is attached by friction to the screw turned by the milled head, so that, by holding fast the milled head, the micrometer head can be turned round for adjustment.

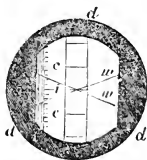

e is the eye-piece, which slides with friction into the cell, *c*, so as to produce distinct vision of the spider's lines of the micrometer. The object-glass, *o*, is held by a conical piece, *dd*, which screws further into or out of the body of the instrument, so as to produce distinct vision of the divided limb to be read by the microscope, and, when adjusted, is held firmly in its place by the nut, *bb*. The microscope screws into a collar, so as to be capable of adjustment with respect to its distance from the divided limb, and, when so adjusted, is held firmly in its place by the nuts, *nn, n'n'*.

Adjustments of the Reading Microscope.—Screw the object-glass home. Insert the body of the microscope into the collar destined to receive it, and screw home the nuts, nn and $n'n'$. Make the diaphragm and spider's lines visible distinctly, by putting the eye-piece, e , the proper depth into the cell, c . Then make the graduated limb also distinctly visible without parallax by turning the nuts, nn , and $n'n'$, unscrewing one and screwing up the other till the desired object is attained.

Now bring the point of intersection of the spider's lines upon a stroke of the limb, and turn the micrometer head, m , to zero; then, turning the screw through five revolutions, if the point of intersection of the spider's lines has not moved over the whole of one of the divided spaces on the limb, the object lens must be screwed up to diminish the power by turning the cone, dd ; and if it has moved over more than one of the divided spaces, it must be unscrewed to increase the power, and then altering the position of the microscope, by turning the nuts, nn and $n'n'$, till distinct vision of the limb is again obtained, the measure of the space, moved over by five revolutions of the screw, must be repeated, as before. When, after repeated trials, the result is satisfactory, the three nuts, nn , $n'n'$, and bb , must be screwed tight home, to render the adjustment permanent.

When the microscope has been thus adjusted for distance, the zero of the division on the limb must be brought to the point of intersection of the spider's lines, and the divided head, m , turned, till its zero is pointed to by its index, and then, if the zero on the comb, cc , be not covered exactly by the index, i , the comb must be moved by turning the screw, i , which enters the bottom of the micrometer box, till its zero is covered by the index pin. The adjustment of the reading microscope will now be perfect; and the graduated limb to be read by it, being divided at every five minutes, the degree and nearest five minutes of an observed angle will be shown by the pointer or index to this graduated limb; while the number of complete revolutions, and the parts of a revolution, of the screw, in the order of the numbers upon the micrometer head, m , required to bring the point of intersection of the spider's lines upon a division of the graduated limb, will be the number of minutes and seconds, respectively, to be added to the degrees and minutes shown by the index of the circle. The complete revolutions, or minutes, to be added, are shown by the number of teeth the index, i , has passed over from zero, and the parts of a revolution, or seconds and

tenths to be added, are pointed out upon the micrometer head m , by its index.

THE COLLIMATOR.

BB , is a rectangular mahogany box partly filled with mercury. FF , is a float of cast iron partly immersed in the mercury. bb , are two iron-bearing pieces, screwed to the bottom of the box by short iron screws; and each of these pieces has two vertical plates turned up, the inner one of which has a longitudinal slit in it, into which slits iron pivots, screwed into the sides of the float, are admitted. The use of these parts is to keep the sides of the float parallel to the sides of the box, and at an inch, or more, from contact with any part of the box, that the mercury may assume a flat surface. II and KK are two holding pieces of metal cast along with the float, and are perforated, to receive each a socket. The socket at H receives an achromatic object-glass, and is adjustable by a screw for its focal distance, and the socket at K holds two cross wires; while another socket, let into the end of the box at L ,

carries a lens forming an eye-piece; so that the collimator is in fact an astronomical telescope with a system of cross wires in the common focus of the object-glass and eye-lens. The inclination, as compared

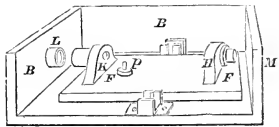

with the surface of the fluid, of the optical axis of this telescope, or of the line joining the center of the object-glass and the intersection of the cross wires, can be modified by the addition of perforated pieces of iron, held steady by the vertical pin, P , and by their weight depressing the end of the float. The mercury must be as pure as can be obtained, and particles of dust must be constantly excluded by a lid that covers over the top of the box. At M is a circular hole, closed when the instrument is not in use, through which the telescope, of which the error of collimation is sought, is to be directed; and a lamp is placed behind the eye-lens at L , to illuminate the cross wires.

Use of the Collimator with an Altitude and Azimuth Instrument.—Place the collimator in the plane of the meridian on the south side of the observatory, and direct it so that the cross wires of the telescope of the altitude and azimuth instru-

ment may be seen through it, in the center of the field of view; then also will the cross wires of the collimator be seen through the telescope in the center of its field of view. Read off the altitude of the cross wires of the collimator, and then, turning the instrument half round in azimuth, observe again the cross wires of the collimator, and read off the angle upon the vertical limb, which will now be a zenith distance. The difference between the sum of these readings and 90° , is the correction which is to be applied to the altitudes and zenith distances observed with the instrument.

Example.—The sun's meridian altitude had been observed on the 20th December, 1826, and the following determination of the error was made immediately after the observations were finished; viz:—

Before reversion the apparent altitude of the cross wires was	0° 1' 2''·33
After reversion the apparent zenith distance of the cross wires was	89 58 10 ·33
	89 59 12 ·66
Sun	89 59 12 ·66
Defect from 90°	47 ·33
Correction of errors of collimation, &c.	23 ·66
Altitude of cross wires corrected = $\left\{ \begin{array}{l} 1' 2''·33 \\ + 23 \cdot 66 \end{array} \right\}$ =	1 26 ·00
Zenith distance . . . = $\left\{ \begin{array}{l} 89^\circ 58' 10''·33 \\ + 23 \cdot 66 \end{array} \right\}$ =	89 58 34 ·00
	90 0 0 ·00

The collimator may also be used for a meridian mark with the transit instrument. When used with a circle for measuring altitudes and zenith distances, which has no motion in azimuth, the collimator must be moved from the north to the south side of the observatory, and the mean of the observations in each of these two positions will give the correction for the errors of collimation, &c., as above.

PART V.—ON THE GONIOMETER.

THE last instrument to which we shall call attention in this little work, is Wollaston's Goniometer, used for measuring the angles of crystals. The following lucid description of the construction and method of using this instrument is extracted from the able article on Crystallography in the "Encyclopædia Metropolitana."

"The instruments used for measuring the angles at which the planes of crystals incline to each other, are called Goniometers.

"The mutual inclination of any two planes, as of a and b , fig. 1, is indicated by the angle formed by two lines, ed , ef , drawn upon them from any point, e , on the edge at which they meet, and perpendicular to that edge.

"Now it is known that if two right lines, as gf , dh , fig. 2, cross each other at any point, e , the opposite angles, def , geh , are equal. If, therefore, the lines, gf , dh , are supposed to be very thin and narrow plates, and to be attached together by a pin at e , serving as an axis to permit the point, f , to be brought nearer either to d , or to h , and that the edges, ed , ef , of those plates, are applied to the planes of the crystal, fig. 1, so as to rest upon the lines, ed , ef , it is obvious that the angle, geh , of the moveable plates would be exactly equal to the angle, def , of the crystal.

"The common goniometer is a small instrument for measuring this angle, geh , of the moveable plates. It consists of a semicircle, fig. 3, divided into 360 equal parts, or half degrees, and a pair of moveable arms, dh , gf , fig. 4, the semicircle having a pin at i , which fits into a hole in the moveable arms at e .

Fig. 3.

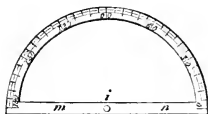
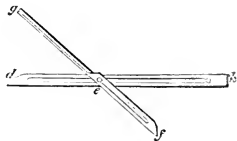

Fig. 4.



"The method of using this instrument is to apply the edges, de , ef , of the moveable arms to the two adjacent planes of any crystal, so that they shall actually touch or rest upon those planes in directions perpendicular to their edge. The arm, dh , is then to be laid on the plate, mn , of the semicircle, fig. 3, the hole at e being suffered to drop on the pin at i , and the edge nearest to h of the arm will then indicate on the semicircle, as in fig. 5, the number of degrees which the measured angle contains.

"When this instrument is applied to the planes of a crystal, the points, d and f , fig. 4, should be previously brought sufficiently near together for the edges, de , ef , to form a more acute angle than that about to be measured. The edges being then gently pressed upon the crystal, the points, d and f , will be gradually separated, until the edges coincide so accurately with the planes that no light can be perceived between them.

Fig. 5.

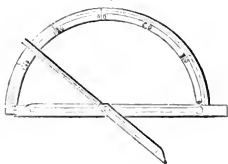

"The common goniometer is, however, incapable of affording very precise results, owing to the occasional imperfection of the planes of crystals, their frequent minuteness, and the difficulty of applying the instrument with the requisite degree of precision.

"The more perfect instrument, and one of the highest value to crystallography, is the reflecting goniometer, invented by Dr. Wollaston, which will give the inclination of planes whose area is less than $\frac{1}{100000}$ of an inch, to less than a minute of a degree.

"This instrument has been less resorted to than might, from its importance to the science, have been expected, owing, perhaps, to an opinion of its use being attended with some difficulty. But the observance of simple rules will render its application easy.

"The principle of the instrument may be thus explained:—

"Let ab , fig. 6, represent a crystal, of which one plane only is visible in the figure, attached to a circle, graduated on its edge, and moveable on its axis at o ; and let a and b mark the position of the two planes whose mutual inclination is required.

"And let the lines, oe, og , represent imaginary lines, resting on those planes in directions perpendicular to their common edge, and the dots at i and h , some permanent marks in a line with the center, o .

"Let the circle be in such a position that the line, oe , would pass through the dot at h , if extended in that direction, as in fig. 6.

"If the circle now be turned round with its attached crystal, as in fig. 7, until the imaginary line, og , is brought into the position of the line, oe , in fig. 6, the number 120 will stand opposite the dot at i . This is the number of degrees at which the planes a and b incline to each other. For

if the line og be extended in the direction oi , as in fig. 7, it is obvious that the lines, oe, oi , which are perpendicular to the common edge of the planes, a and b , would intercept exactly 120° of the circle.

"Hence an instrument constructed upon the principle of these diagrams is capable of giving with accuracy the mutual inclination of any two planes which reflect objects with sufficient distinctness, if the means can be found for placing them successively in the relative positions shown in the two preceding figures.

"This purpose is effected by causing an object, as the line at m , fig. 8, to be reflected successively from the two planes, a and b , at the same angle. It is well known that the images of objects are reflected from bright planes at the same angle as that at which their rays fall on those planes; and that

Fig. 6.

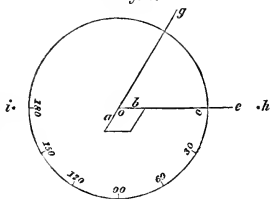
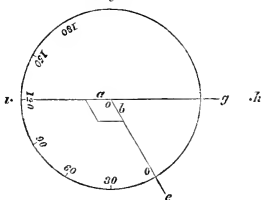

Fig. 7.



when the image of an object reflected from a horizontal plane is observed, it appears so much below the reflecting surface as the object itself is above.

"If, therefore, the planes *a* and *b*, fig. 8, are successively brought into such positions as will cause the reflection of the line at *m*, from each plane, to appear to coincide with another line at *n*, both planes will be successively placed in the relative positions of the corresponding planes in figs.

6 and 7. To bring the planes of any crystal successively into these relative positions, the following directions will be found useful.

"The instrument, as shown in the sketch, fig. 9, should be first placed on a pyramidal stand, and the stand on a small steady table, about six or ten or twelve feet from a flat window. The graduated circular plate should stand perpendicularly from the window, the pin *x* being horizontal, not in the direction of the axis, as it is usually figured, but with the slit end nearest to the eye.

"Place the crystal which is to be measured on the table, resting on one of the two planes whose inclination is required, and with the edge at which those planes meet, nearest and parallel to the window.

"Attach a portion of wax, about the size of *d*, to one side of a small brass plate, *e*, fig. 10; lay the plate on the table with the edge, *f*, parallel to the window, the side to which the wax is attached being uppermost, and press the end of the wax against the crystal until it adheres; then lift the plate with its attached crystal, and place it in the slit of the pin, *x*, with that side uppermost which rested on the table.

"Bring the eye now so near the crystal, as, without perceiving the crystal itself, to permit the images of objects reflected from its planes to be distinctly observed, and raise or lower that end of the pin, *x*, which has the small circular plate on it, until one of the horizontal upper bars of the window is seen reflected from the upper or first plane of the crystal, corresponding with the plane *a*, fig. 6, and until the image of the bar appears to touch some line below the window, as the edge of the skirting-board where it joins the floor.

"Turn the pin, *x*, on its own axis also, if necessary, until the reflected image of the bar of the window coincides accurately with the observed line below the window.

"Turn now the small circular handle, *a*, on its axis, until the same bar of the window appears reflected from the second plane of the crystal corresponding with plane *b*, figs. 6 and 7, and until it appears to touch the line

Fig. 3.

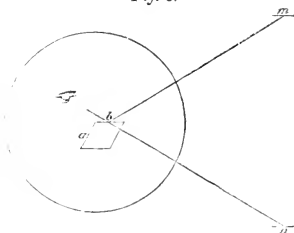

Fig. 9.

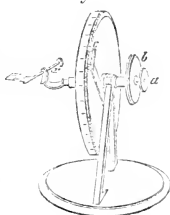
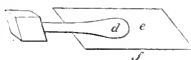

Fig. 10.



below; and having, in adjusting the *first* plane, turned the pin, *x*, on its axis, to bring the reflected image of the bar of the window to coincide accurately with the line below, now move the lower end of the pin laterally, either towards or from the instrument, in order to make the image of the same bar, reflected from the second plane, coincide with the same line below.

“Having ascertained by repeatedly looking at, and adjusting both planes, that the image of the horizontal bar, reflected successively from each plane, coincides with the observed lower line, the crystal may be considered ready for measurement.

“Let the 180° on the graduated circle be now brought opposite the 0 of the vernier at *c*, by turning the handle, *b*; and while the circle is retained accurately in this position, bring the reflected image of the bar from the *first* plane, to coincide with the line below, by turning the *small* circular handle, *a*. Now turn the graduated circle, by means of the handle, *b*, until the image of the bar, reflected from the *second* plane, is also observed to coincide with the same line below. In this state of the instrument the vernier at *c* will indicate the degrees and minutes at which the two planes are inclined to each other.

“The accuracy of the measurements taken with this instrument will depend upon the precision with which the image of the bar, reflected successively from both planes, is made to appear to coincide with the same line below; and also upon the 0, or the 180° , on the graduated circle, being made to stand precisely even with the lower line of the vernier, when the first plane of the crystal is adjusted for measurement. A wire being placed horizontally between two upper bars of the window, and a black line of the same thickness being drawn parallel to it below the window, will contribute to the exactness of the measurement, by being used instead of the bar of the window and any other line.

“Persons beginning to use this instrument are recommended to apply it first to the measurement of fragments at least as large as that represented in fig. 10, and of some substance whose planes are bright. Crystals of carbonate of lime will supply good fragments for this purpose, if they are merely broken by a slight blow of a small hammer.

“For accurate measurement, however, the fragments ought not, when the planes are bright, to exceed the size of that shown in fig. 9, and they ought to be so placed on the instrument, that a line passing through its axis should also pass through the center of the small minute fragment which is to be measured. This position on the instrument ought also to be attended to when the fragments of crystal are large. In which case the common edge of the two planes, whose inclination is required, should be brought very nearly to coincide with the axis of the goniometer; and it is frequently useful to blacken the whole of the planes to be measured, except a narrow stripe on each close to the edge over which the measurement is to be taken.”

INDEX.

- ABERRATION and aplanatism of lenses explained, 71.
- Achromatic eye-piece, 73.
- Aerial telescope, 81.
- Altitude and azimuth instrument, description of, 153; adjustments of, 156; use of, 157.
- Angles, methods of setting off, 16, 39; measuring, 16.
- Area, of a drawing, reduced or enlarged, 52; of a board or plank found, 59; of a survey computed, 135.
- Artificial horizon, 121.
- Astronomical triangle, 158; table of formulæ connecting the parts of, 159.
- Bench marks, 111.
- Bisection of a straight line, 36.
- Bow compasses, 4.
- Box sextant, described, 117; its parallax explained, 119; and eliminated, 121.
- Camera obscura, 89; lucida, 90.
- Cassini, his aerial telescope, 81.
- Cassegrainian telescope, 84.
- Chains, Gunter's and land, 92.
- Chords, line of, constructed, 14; uses of, 16.
- Chromatic dispersion of light explained, 72.
- Clamping screw, 47.
- Collimation, line of, 100.
- Collimator, description of, 162; use of, 162.
- Compasses, 1; beam, 48; bow, 4; hair, 2; with movable points, 3; proportional, 4; triangular, 6.
- Compass, prismatic, 115.
- Content of a drawing reduced or enlarged, 5; solid, measured, 30.
- Copying drawings, 52.
- Course, method of setting off a, 16.
- Crystals measured, 165.
- Cube root, extraction of, 6.
- Cylindrical vessel, its content in gallons measured, 63.
- Development of a portion of a sphere, 22.
- Diagonal scale, 10.
- Dial, horizontal, 23; erect south, 25; east and west, 25.
- Dip sector, 144.
- Division, arithmetical, 29, 56; of a line into equal parts, 36.
- Drawing, a, its linear dimensions reduced or enlarged, 5, 38, 51, 53; its area reduced or enlarged, 5; its solid content reduced or enlarged, 6.
- Drawing-paper, management of, 64; dimensions of, 65.
- Drawing pen, 7.
- Edge, straight, 8.
- Equal parts, scales of, 9.
- Eye-piece, celestial negative, 82; positive, 83; terrestrial, or erect, 83.
- Famstead's projection, 23.
- Geometrical construction, general rules, 66.
- Gnomon, 24.
- Gnomonic projection, 19.
- Goniometer, common, 164; Wollaston's, 165.
- Gravatt, his adjustment of the level, 102; his level, 105.

- Gregorian telescope, 84.
 Gunter's chain, 92; Gunter's lines, their construction, 25; their use, 28.
 Hadley's sextant, described, 137; its adjustments, 139; its index error determined, 140.
 Herschel, his telescope, 84.
 Horizon, artificial, 121.
 Huyghens, his aerial telescope, 81; his eye-piece, 82.
 Land chain, 92.
 Lenses, various forms of, and effects produced by them, 70; their focal lengths defined, 72; focal length of a convex lens practically determined, 72; images formed by lenses, 73.
 Level, spirit, 96; the Y level, 97; its adjustments, 101; Troughton's level, 104; Gravatt's level, 105; water level, 112; reflecting level, 113.
 Levelling staff, 104.
 Levelling, remarks on, 106; for sections, 108; field-book, 109.
 Light, pencils of, defined, 67; chromatic dispersion of, 72.
 Linear measures, table of, 92.
 Marquois's scales, 42.
 Mean proportional found, 58.
 Micrometer, 47.
 Microscopes, refracting, described, 76; their magnifying powers determined, 79; reflecting, described, 80; the reading microscope described, 160; its adjustments, 161; the solar microscope, 88.
 Mirrors, glass, secondary images formed in them, 75.
 Mounting, varnishing, &c., paper and drawings, 65.
 Multiplication, 28, 56.
 Newtonian telescope, 84.
 Numbers, line of, 25.
 Offsetting staff, 95.
 Opera-glass, or Galilean telescope, 84.
 Optical square, 122.
 Orthographic projection, 13.
 Pantagraph, 50.
 Parallax, of a telescope, 100; of a sextant, 119.
 Parallel lines drawn, 43.
 Pen, drawing, 7; road, 8.
 Perpendicular lines drawn, 44.
 Plain scale, 33.
 Plotting scales, 50, 133; sections, 111; a survey, 129.
 Polygon, inscribed in a circle, 5, 40; formed upon a given line, 40.
 Pricking point, 8.
 Prism, defined, 67; its effects upon light explained, 68; its uses in optical instruments, 69.
 Prismatic compass, 115.
 Proportion, 29, 36, 56.
 Protracting scales, 14.
 Protractors, upon plain scales, 33; circular, 129; semicircular, 131.
 Radius found, from the length of the sine, tangent, or secant, of an arc, 42.
 Ramsden, his eye-piece, 83.
 Reflectors, plane, their effects and uses in optical instruments, 74; curvilinear reflectors, 75; methods of forming and polishing parabolic reflectors, 76, foot note.
 Reflecting circle, described, 141; directions for observing with it, 142.
 Rhumbs, line of, 16, 17; sine rhumbs, 28; tangent rhumbs, 28.
 Scales, of equal parts simply divided, 9; diagonal, 10; vernier, 11; formed by sector, 38; of chords, sines, versed sines, tangents, secants, and semitangents, 14; of rhumbs, chords, and longitudes, 15; of hour-lines and latitudes, 15; logarithmic, *see* Gunter's lines; Marquois's, 42.
 Screw, clamping, 47; tangent, 47.
 Secant, to any desired radius, found, 41.
 Sector, 33.
 Sextant, box, 117; Hadley's, 137.
 Sines, scales of, 14; to any desired radius, found, 41; logarithmic, *see*

- Gunter's lines, 25; sine rhumbs, 28.
- Sliding rule, 55.
- Solid contents found, 30; of squared timber, 60; of tapering timber, 59.
- Sphere, its orthographic projection, 18; gnomonic projection, 19; stereographic projection, 20; development of a portion, 22; Flamstead's projection, 23.
- Spherical confusion of lenses explained, 72.
- Spirit level, 96.
- Square, of a number, found, 57; root, 6; measures, table of, 93.
- Station pointer, 135.
- Superficies, or area, measured, 29.
- Surveying, remarks upon, 126.
- T square, 131.
- Tables, giving the correction to be subtracted from the approximate content of timber, as determined by the sliding rule, 61; of dimensions of drawing paper, 65; of linear measure, 92; of square measures, 93; showing the reduction in links and decimals of a link upon 100 links for every half degree of inclination from 3° to $20^\circ 30'$, 95; showing the reduction in feet and decimals of a foot upon 100 feet for each foot difference of level, 110; of formulæ for determining the time, the latitude of place of observation, and the declination of a heavenly body, from observations made with the altitude and azimuth instrument, 159.
- Tangents, scale of, 14; to any desired radius, found, 42; logarithmic, 27; tangent rhumbs, 28; tangent screw, 47.
- Telescopes, refracting, astronomical, 81; with achromatic object glasses, 82; Galilean, or opera glasses, 84; refracting, adjusted, and tested, 86; reflecting, why required, 84; Newtonian, 84; Gregorian, 84; Cassegrainian, 85; Herschelian, 85; reflecting, adjusted, and tested, 88.
- Theodolite, described, 122; adjustments of horizontal limb, 125; adjustments of vertical limb, 125; surveying with, 127.
- Transit instrument, described, 144; its adjustments, 147; method of making and recording observations, 151; use of the *portable* transit, 153.
- Triangle, isosceles, having each of the angles at the base double of the third angle, constructed, 40; right-angled, solved, 31.
- Troughton, his level, 104; his reflecting circle, 141.
- Vernier, described, 45; scale, 11.
- Versed sines, scales of, 14.
- Vision by means of lenses, 70.
- Wholes and halves, 4.
- Y level, 97

LIST

OF

MATHEMATICAL, OPTICAL,

AND

PHILOSOPHICAL INSTRUMENTS

Manufactured by

WILLIAM ELLIOTT AND SONS,

56, STRAND, LONDON.

	£	s.	d.
Four-inch plain Theodolite	13	13	0
Four-inch best Theodolite, divided on Silver	15	15	0
Ditto ditto ditto, with Tangent Screw Adjustments	20	0	0
Five-inch Theodolite	16	16	0
Ditto, divided on Silver, with Tangent Screw Adjustments	24	3	0
Six-inch Theodolite	18	18	0
Ditto, divided on Silver to 20 Seconds, with Tangent Screw Adjustments	29	8	0
Ditto ditto, with 2 Telescopes	38	0	0
Seven-inch best Theodolite	34	13	0
Ditto ditto, with 2 Telescopes	44	2	0
Five-inch best Transit Theodolite	29	8	0
Six-inch ditto ditto	34	13	0
Seven-inch ditto ditto	40	19	0
Everest Theodolite, 4-inch	21	0	0
Ditto ditto, 5-inch	25	4	0
Small Level, with Stand, for drainage	6	6	0
Ten-inch Y Level	9	9	0
Fourteen-inch Y Level with Compass	14	14	0
Elliott's improved Dumpy Level	14	14	0
Ditto ditto, with Compass	16	16	0
Ditto ditto, 14-inch	15	15	0
Ditto ditto ditto, with Compass	17	17	0
Ditto, ditto, extra large	21	0	0
Circumferenters	from 5l. 15s. 6d. to	15	15
Prismatic Compass	3l. 3s. to	3	13
Pocket Sextant		4	4
Ditto, with Telescope		4	14
Ditto, ditto, and Supplementary Arc		5	15
Optical Square		1	1
Pentagraphs	5l. 15s. 6d. to	10	10
Eidograph		10	10
Transit Instruments	16l. 16s. to	73	10

		£	s.	d.
Cross Staff	10s. 6d. to	0	16	0
Ditto, with Compass and Screw Staff	2l. 2s. to	2	12	6
Miners' Compass	5l. 5s. to	18	18	0
Circular Protractors, with Verniers	3l. 13s. 6d. to	7	17	6
Metal Circular and Semicircular Protractors	10s. 6d. to	5	5	0
Level Staff, 14-feet, portable	from 2l. 15s. to	3	0	0
Ditto, 17-feet		4	14	6
Gravatt's Level Staff	3l. 3s. to	4	4	0
Papers for Level Staves	per foot	0	0	2
Ditto, in sets, for 14-feet Portable Staff		0	3	0
Chain, 66-feet	10s. to	0	18	0
Standard Chains	3l. 3s. to	5	5	0
Arrows, set		0	2	0
Tapes, 33-feet to 100-feet	6s. to	1	1	0
Pocket Tapes	3s. to	0	10	6

Four-inch Metal Sextant, divided on Silver		9	9	0
Five-inch ditto ditto		12	12	0
Six-inch ditto ditto		13	13	0
Seven-inch ditto ditto		15	15	0
Eight-inch ditto ditto		16	16	0
Ditto ditto ditto, with double frame		17	17	0
Quadrant	2l. 12s. 6d. to	6	6	0
Artificial Horizon	2l. 12s. 6d. to	4	14	6

	Brass.			German Silver.		
	£	s.	d.	£	s.	d.
Proportional Callipers, 12 inches	2	0	0	2	12	6
Ditto ditto, 9 inches	1	14	0	2	2	0
Proportional Compass, 12 inches	3	0	0	3	13	6
Ditto ditto, 9 inches	2	5	0	3	3	0
Ditto ditto, 6 inches	1	10	0	2	0	0
Ditto ditto, ditto, with Adjustment	2	0	0	2	10	0
Whole and half ditto	0	18	0	1	4	0
Triangle ditto	0	18	0	1	4	0
Tube Compass	1	15	0	2	5	0
Ditto, Needle Points	1	18	0	2	8	0
Tube Beam Compass	2	0	0	2	12	6
Pocket Turn-in Compass	1	6	0	1	16	0
Ditto ditto, with handles	1	10	0	2	2	0
Ditto ditto, ditto, and Bars	2	2	0	2	12	6
Pillar Compass, with divided Sheath	1	11	6	2	2	0
Napier Compass				2	2	0
Pocket Dividers, with Sheath	0	8	0	0	10	0
Best double-jointed Compass	0	15	0	1	1	0
Ink Pencil, and Wheel Legs for ditto	each	0	5	0	7	6
Lengthening Bar		0	5	0	0	7
Hair Divider		0	10	0	0	13
Plain Divider		0	6	0	0	8
Tate's Bow		1	4	0	1	11
Double-jointed Bowpen and Bowpencil	each	0	10	6	0	13
Ditto ditto, Needle-pointed	each	0	12	0	0	15

	Brass.			German Silver.		
	£	s.	d.	£	s.	d.
Hair Bow Divider	0	9	0	0	12	0
Large Needle Bows each	0	15	0	1	1	0
Spring Bowpen and Pencil each	0	8	6	0	8	6
Spring Divider	0	7	6	0	7	6
Ivory Handle Drawing Pen	0	5	0	0	5	0
Ditto, ditto, jointed	0	5	6	0	7	0
Ebony ditto	0	3	6	0	3	6
Double Pen	0	10	6	0	10	6
Six Wheels and Box	0	6	6	0	6	6
Six Pens and one Handle	1	6	0	1	6	0
Tracer	0	2	6	0	2	6
Crow Quill Holder	0	3	0	0	3	0
Needle Holder	0	2	6	0	3	0
Knife	0	1	6	0	1	6
<hr/>						
Sector jointed Compass, 4½, 5 or 6 in.	0	10	0	0	15	0
Divider	0	6	0	0	8	0
Ink, Pencil, and Wheel Legs each	0	5	6	0	7	6
Bar	0	5	0	0	7	0
Bowpen and Bowpencil	0	12	0	0	16	0
<hr/>						
Marlow Compass	0	9	0	0	13	0
Divider	0	4	6	0	6	6
Ink and Pencil Legs	0	9	0	0	13	0
Bar	0	4	6	0	6	6
<hr/>						
College Compass	0	7	0			
Ink and Pencil Legs	0	7	0			
Divider	0	3	6			
Ink and Pencil Bows	0	7	0			
<hr/>						
Steel Joint Compass, with Pen and Pencil Legs	0	7	6			
Divider	0	2	6			
Bowpen and Pencil	0	6	0			
Drawing Pen	0	2	0			
<hr/>						
Case of Instruments, as supplied to the Royal Military Academy				2	12	6
Ditto, as supplied to the College of Civil Engineers at Putney				3	10	0
Ditto, as supplied to King's College, London				2	15	0
Ditto, as supplied to the College, Cheltenham				3	3	0
Ditto, as supplied to the Cadets at Addiscombe, 3 <i>l.</i> 3 <i>s.</i> , 3 <i>l.</i> 13 <i>s.</i> 6 <i>d.</i> , and				4	4	0
Magazine Cases of Instruments made of Brass, German Silver, or Silver, from 10 <i>l.</i> 10 <i>s.</i> to				50	0	0
<hr/>						
Sector				6 <i>s.</i>	to	1 1 0
Marquis Scales, Boxwood						0 12 0
Ditto, Ivory						2 12 6
Ditto, German Silver						3 13 6

	£	s.	d.
Ivory Plotting Scales, 12 inches	0	10	0
Ditto ditto, 6 inches	0	5	0
Ditto Offset Scales, 2 inches	0	2	6
Ditto Architect's Scales, 12 inches	0	13	0
Ditto ditto, 6 inches	0	7	0
Ditto Protractor, 12 inches	1	10	0
Ditto ditto, 6 inches	0	6	0
Ditto Parallel Rule, Brass Bars	0	4	6
Ditto ditto, German Silver Bars	0	6	0
Ditto Pocket Rules	4s. 6d. to	1	11 6
Slide Rules	0	5	0
Routledges' Slide Rule, with Book	0	9	0
Hawthorn's ditto, with Book	0	12	0
Box Plotting Scales, 12 inches	0	4	0
Ditto Offsets	0	1	6
Ditto Architect's Scale	0	6	0
Ditto Pocket Rules	2s. 6d. to	0	14 0
Ebony Parallel Rule, 4d. per inch.			
Rolling Parallel Rules, 1s. per inch.			
Ditto ditto, with Ivory Edges, 1s. 8d. per inch.			
Rolling Protractor, Ivory	0	18	0
Metal Standard Scale, stamped by Tithe Commissioners	1	1	0
English and Foreign Standard Measures made to Order.			
Steel Straight Edges, 6s. per foot.			
Lancewood T. Squares, 3s. per foot.			
Ebony T. Squares, 4s. per foot.			
Computing Scales	0	16	0
Centrolinead	1l. 8s. to	1	11 6
Sets of Radii Curves	1l. 1s. to	5	5 0
Trammels	2l. 12s. 6d. to	5	5 0
Beam Compasses	1l. to	5	5 0
<hr/>			
Twelve-inch Achromatic Telescope	15s. to	1	11 6
Eighteen-inch ditto	1l. 1s. to	2	2 0
Twenty-four-inch ditto	2l. 2s. to	3	3 0
Thirty-six-inch ditto	4l. 4s. to	5	5 0
Twelve-inch Portable Achromatic Telescope	1l. 11s. 6d. to	2	2 0
Eighteen-inch ditto ditto	2l. 2s. to	2	12 6
Twenty-four-inch ditto ditto	2l. 12s. 6d. to	3	3 0
Military Telescope, in Leather Case and Strap		3	10 0
Naval Telescopes	from 1l. 4s. to	6	6 0
Thirty-inch Astronomical Telescope, on Stand			12 12 0
Forty-five inch ditto ditto, 2 $\frac{3}{4}$ aperture			25 4 0
Ditto ditto ditto, 3 $\frac{1}{2}$ aperture			42 0 0
Telescopes, Opera Glasses, Spectacles, Barometers, and all descriptions of Optical and Philosophical Instruments.			
Elliott's Drawing Pencils, and small Pencils to fit Instruments. Tachet's Patent Drawing Boards, Colours, Drawing Paper, &c., &c.			

NEW [AND PERMANENT] LIST OF WORKS

PUBLISHED BY

JOHN WEALE, 59, HIGH HOLBORN, LONDON.

SERIES OF RUDIMENTARY WORKS

FOR THE USE OF BEGINNERS.

1857.

1. CHEMISTRY, by Prof. Fowkes, F.R.S., including Agricultural Chemistry, for the use of Farmers. 4th edition 1s.
2. NATURAL PHILOSOPHY, by Charles Tomlinson. 2nd edition 1s.
3. GEOLOGY, by Lieut.-Col. Portlock, F.R.S., &c. 2nd edition 1s. 6d.
- 4, 5. MINERALOGY, by D. Varley, 2 vols. 2nd edition 2s.
6. MECHANICS, by Charles Tomlinson. 2nd edition 1s.
7. ELECTRICITY, by Sir William Snow Harris, F.R.S. 3rd edition 1s. 6d.
- 8, 9, 10. MAGNETISM, by the same, 3 vols. 3s. 6d.
- 11, 11* ELECTRIC TELEGRAPH, History of the, by E. Highton, C.E., double Part 2s.
12. PNEUMATICS, by Charles Tomlinson. 2nd edition 1s.
- 13, 14, 15. CIVIL ENGINEERING, by Henry Law, C.E., 3 vols.; and 15* Supplement 4s. 6d.
16. ARCHITECTURE (Orders of), by W. H. Leeds. 2nd edition 1s.
17. ARCHITECTURE (Styles of), by T. Bury, Architect. 2nd edition, with additional cuts 1s. 6d.
- 18, 19. ARCHITECTURE (Principles of Design in), by E. L. Garbett, Architect, 2 vols. 2s.
- 20, 21. PERSPECTIVE, by G. Pyne, Artist, 2 vols. 3rd edition 2s.
22. BUILDING, Art of, by E. Dobson, C.E. 2nd edition 1s.
- 23, 24. BRICK-MAKING, TILE-MAKING, &c., Art of, by the same, 2 vols. 2s.
- 25, 26. MASONRY AND STONE-CUTTING, Art of, by the same, with illustrations of the preceding, in 16 4to. atlas plates 2s.
- 27, 28. PAINTING, Art of, or a GRAMMAR OF COLOURING, by George Field, Esq., 2 vols. 2s.
29. DRAINING DISTRICTS AND LANDS, Art of, by G. R. Dempsey, C.E. 1s.
30. DRAINING AND SEWAGE OF TOWNS AND BUILDINGS, Art of, by G. R. Dempsey, C.E. 1s. 6d.
31. WELL-SINKING AND BORING, Art of, by G. R. Burnell, C.E. 2nd edition 1s.
32. USE OF INSTRUMENTS, Art of the, by J. F. Heather, M.A. 3rd edition 1s.
33. CONSTRUCTING CRANES, Art of, by J. Glynn, F.R.S., C.E. 1s.
34. STEAM ENGINE, Treatise on the, by Dr. Lardner 1s.
35. BLASTING ROCKS AND QUARRYING, AND ON STONE, Art of, by Lieut.-Gen. Sir J. Burgoyne, K.C.B., R.E. 2nd edition 1s.

RUDIMENTARY WORKS.

- 36, 37, 38, 39. **DICTIONARY OF TERMS** used by Architects, Builders, Civil and Mechanical Engineers, Surveyors, Artists, Ship-builders, &c., 4 vols. 4s.
40. **GLASS-STAINING, Art of**, by Dr. M. A. Gessert 1s.
41. **PAINTING ON GLASS, Essay on**, by E. O. Fromberg 1s.
42. **COTTAGE BUILDING, Treatise on**, 2nd edition 1s.
43. **TUBULAR AND GIRDER BRIDGES**, and others, Treatise on, more particularly describing the Britannia and Conway Bridges, with Experiments 1s.
44. **FOUNDATIONS, &c.**, Treatise on, by E. Dobson, C.E. 1s.
45. **LIMES, CEMENTS, MORTARS, CONCRETE, MASTICS, &c.**, Treatise on, by Geo. R. Burnell, C.E. 1s.
46. **CONSTRUCTING AND REPAIRING COMMON ROADS**, Treatise on the Art of, by H. Law, C.E. 1s.
- 47, 48, 49. **CONSTRUCTION AND ILLUMINATION OF LIGHTHOUSES**, Treatise on the, by Alan Stevenson, C.E., 3 vols. 3s.
50. **LAW OF CONTRACTS FOR WORKS AND SERVICES**, Treatise on the, by David Gibbons, Esq. 1s.
- 51, 52, 53. **NAVAL ARCHITECTURE, Principles of the Science**, Treatise on, by J. Peake, N.A., 3 vols. 3s.
54. **MASTING, MAST-MAKING, AND RIGGING OF SHIPS**, Treatise on, by R. Kipping, N.A. 1s. 6d.
- 55, 56. **NAVIGATION, Treatise on: THE SAILOR'S SEA-BOOK**.—How to keep the log and work it off—Latitude and longitude—Great Circle Sailing—Law of Storms and Variable Winds; and an Explanation of Terms used, with coloured illustrations of Flags, 2 vols. 2s.
- 57, 58. **WARMING AND VENTILATION**, Treatise on the Principles of the Art of, by Chas. Tomlinson, 2 vols. 2s.
59. **STEAM BOILERS**, Treatise on, by R. Armstrong, C.E. 1s.
- 60, 61. **LAND AND ENGINEERING SURVEYING**, Treatise on, by T. Baker, C.E., 2 vols. 2s.
62. **RAILWAY DETAILS, Introductory Sketches of**, by R. M. Stephenson, C.E. 1s.
- 63, 64, 65. **AGRICULTURAL BUILDINGS**, Treatise on the Construction of, on Motive Powers, and the Machinery of the Steading; and on Agricultural Field Engines, Machines, and Implements, by G. H. Andrews, 3 vols. 3s.
66. **CLAY LANDS AND LOAMY SOILS**, Treatise on, by Prof. Donaldson, A.E. 1s.
- 67, 68. **CLOCK AND WATCH-MAKING, AND ON CHURCH CLOCKS**, Treatise on, by E. B. Denison, M.A., 2 vols. 2s.
- 69, 70. **MUSIC, Practical Treatise on**, by C. C. Spencer, 2 vols. 2s.
71. **PIANO-FORTE, Instruction for Playing the**, by the same 1s.
- 72, 73, 74, 75. **RECENT FOSSIL SHELLS**, Treatise (A Manual of the Mollusca) on, by Samuel P. Woodward, and illustrations, 4 vols. 4s.
- 76, 77. **DESCRIPTIVE GEOMETRY**, Treatise on, by J. F. Heather, M.A., 2 vols. 2s.
- 77*. **ECONOMY OF FUEL**, Treatise on, particularly with reference to Reverberatory Furnaces for the Manufacture of Iron and Steam Boilers, by F. S. Prideaux, Esq. 1s.

RUDIMENTARY WORKS.

- 78, 79. STEAM AS APPLIED TO GENERAL PURPOSES AND LOCOMOTIVE ENGINES, Treatise on, by J. Sewell, C.E., 2 vols. 2s.
- 79* RUDIMENTARY WORK ON PHOTOGRAPHY, containing full instructions in the Art of producing Photographic Pictures on any material and in any colour; and also Tables of the Composition and Properties of the Chemical Substances used in the several Photographic Processes. By Dr. H. Halleur, of Berlin. Translated from the German, by the advice of Baron A. von Humboldt, by Dr. Strauss 1s.
- 80, 81. MARINE ENGINES, AND ON THE SCREW, &c., Treatise on, by R. Murray, C.E., 2 vols. 2s.
- 80*, 81*. EMBANKING LANDS FROM THE SEA, the Practice of, treated as a Means of Profitable Employment of Capital, by John Wiggins, F.G.S., Land Agent and Surveyor, 2 vols. 2s.
- 82, 82*. POWER OF WATER, AS APPLIED TO DRIVE FLOUR-MILLS, Treatise on the, by Joseph Glynn, F.R.S., C.E. 2s.
83. BOOK-KEEPING, Treatise on, by James Haddon, M.A. 1s.
- 82**, 83*. COAL GAS, Practical Treatise on the Manufacture and Distribution of, by Samuel Hughes, C.E., 3 vols. 3s.
- 83**. CONSTRUCTION OF LOCKS, Treatise on the, with illustrations . . . 1s. 6d.
- 83 bis. PRINCIPLES OF THE FORMS OF SHIPS AND BOATS, by W. Bland, Esq. 1s.
84. ARITHMETIC, Elementary Treatise on, the Theory, and numerous Examples for Practice, and for Self-Examination, by Prof. J. R. Young 1s. 6d.
- 84*. KEY to the above, by Prof. J. R. Young 1s. 6d.
85. EQUATIONAL ARITHMETIC: Questions of Interest, Annuities, and General Commerce, by W. Hipsley, Esq. 1s.
- 86, 87. ALGEBRA, Elements of, for the use of Schools and Self-Instruction, by James Haddon, M.A., 2 vols. 2s.
- 88, 89. GEOMETRY, Principles of, by Henry Law, C.E., 2 vols. 2s.
90. GEOMETRY, ANALYTICAL, by James Hann 1s.
- 91, 92. PLANE AND SPHERICAL TRIGONOMETRY, Treatises on, by the same, 2 vols. 2s.
93. MENSURATION, Elements and Practice of, by T. Baker, C.E. 1s.
- 94, 95. LOGARITHMS, Treatise on, and Tables for facilitating Astronomical, Nautical, Trigonometrical, and Logarithmic Calculations, by H. Law, C.E., 2 vols. 2s.
96. POPULAR ASTRONOMY, Elementary Treatise on, by the Rev. Robert Main, M.R.A.S. 1s.
97. STATICS AND DYNAMICS, Principles and Practice of, by T. Baker, C.E. 1s.
- 98, 98*. MECHANISM, AND PRACTICAL CONSTRUCTION OF MACHINES, Elements of, by the same, 2 vols, 2s.
- 99, 100. NAUTICAL ASTRONOMY AND NAVIGATION, Theory and Practice of, by H. W. Jeans, R.N.C., Portsmouth, 2 vols. 2s.
101. DIFFERENTIAL CALCULUS, by W. S. B. Woolhouse, F.R.A.S. 1s.
102. INTEGRAL CALCULUS, by Homersham Cox, M.A. 1s.
103. INTEGRAL CALCULUS, Collection of Examples of the, by James Hann 1s.
104. DIFFERENTIAL CALCULUS, Collection of Examples of the, by J. Haddon, M.A. 1s.
105. ALGEBRA, GEOMETRY, AND TRIGONOMETRY, First Mnemonical Lessons in, by the Rev. Thomas Penyngton Kirkman, M.A. 1s. 6d.

NEW SERIES OF EDUCATIONAL WORKS;

OR

Volumes intended for Public Instruction and for Reference :

THE public favour with which the Rudimentary Works on scientific subjects have been received induces the Publisher to commence a New Series, somewhat different in character, but which, it is hoped, may be found equally serviceable. The **DICTIONARIES** of the **MODERN LANGUAGES** are arranged for facility of reference, so that the English traveller on the Continent and the Foreigner in England may find in them an easy means of communication, although possessing but a slight acquaintance with the respective languages. They will also be found of essential service for the desk in the merchant's office and the counting-house, and more particularly to a numerous class who are anxious to acquire a knowledge of languages so generally used in mercantile and commercial transactions.

The want of small and concise **GREEK** and **LATIN DICTIONARIES** has long been felt by the younger students in schools, and by the classical scholar who requires a book that may be carried in the pocket; and it is believed that the present is the first attempt which has been made to offer a complete Lexicon of the Greek Language in so small a compass.

In the volumes on **ENGLAND, GREECE** and **ROME**, it is intended to treat of History as a Science, and to present in a connected view an analysis of the large and expensive works of the most highly valued historical writers. The extensive circulation of the preceding Series on the pure and applied Sciences amongst students, practical mechanics, and others, affords conclusive evidence of the desire of our industrious classes to acquire substantial knowledge, when placed within their reach; and this has induced the hope that the volumes on History will be found profitable not only in an intellectual point of view, but, which is of still higher importance, in the social improvement of the people; for without a knowledge of the principles of the English constitution, and of those events which have more especially tended to promote our commercial prosperity and political freedom, it is impossible that a correct judgment can be formed by the mass of the people of the measures best calculated to increase the national welfare, or of the character of men best qualified to represent them in Parliament; and this knowledge becomes indispensable in exact proportion as the elective franchise may be extended and the system of government become more under the influence of public opinion.

The scholastic application of these volumes has not been overlooked, and a comparison of the text with the examinations for degrees given, will show their applicability to the course of historic study pursued in the Universities of Cambridge and London.

1, 2.	CONSTITUTIONAL HISTORY OF ENGLAND, 2 vols., by W. D. Hamilton	2s.
3, 4.	————— DOWN TO VICTORIA, by the same	2s.
5.	OUTLINE OF THE HISTORY OF GREECE, by the same	1s.
6.	————— TO ITS BECOMING A ROMAN PROVINCE, by the same	1s. 6d.
7.	OUTLINE HISTORY OF ROME	1s.
8.	————— TO THE DECLINE	1s. 6d.

RUDIMENTARY WORKS.

- 9, 10. A CHRONOLOGY OF CIVIL AND ECCLESIASTICAL HISTORY, LITERATURE, SCIENCE, AND ART, from the earliest time to a late period, 2 vols., by Edward Law. 2s. 6d.
11. GRAMMAR OF THE ENGLISH LANGUAGE, for use in Schools and for Private Instruction, by Hyde Clarke, Esq., D.C.L. 1s.
- 12, 13. DICTIONARY OF THE ENGLISH LANGUAGE. A new and compressed Dictionary of the English Tongue, as Spoken and Written, including above 100,000 words, or 50,000 more than in any existing work, and including 10,000 additional Meanings of Old Words, 2 vols. in 1, by the same 3s. 6d.
14. GRAMMAR OF THE GREEK LANGUAGE, by H. C. Hamilton 1s.
- 15, 16. DICTIONARY OF THE GREEK AND ENGLISH LANGUAGES, by H. R. Hamilton, 2 vols. in 1 2s.
- 17, 18. ————— ENGLISH AND GREEK LANGUAGES, 2 vols. in 1, by the same 2s.
19. GRAMMAR OF THE LATIN LANGUAGE 1s.
- 20, 21. DICTIONARY OF THE LATIN AND ENGLISH LANGUAGES 2s.
- 22, 23. ————— ENGLISH AND LATIN LANGUAGES 1s. 6d.
24. GRAMMAR OF THE FRENCH LANGUAGE, by Dr. Strauss, late Lecturer at Besançon 1s.
25. DICTIONARY OF THE FRENCH AND ENGLISH LANGUAGES, by A. Elwes 1s.
26. ————— ENGLISH AND FRENCH LANGUAGES, by the same 1s. 6d.
27. GRAMMAR OF THE ITALIAN LANGUAGE, by the same 1s.
- 28, 29. DICTIONARY OF THE ITALIAN, ENGLISH, AND FRENCH LANGUAGES, by the same 2s.
- 30, 31. ————— ENGLISH, FRENCH, AND ITALIAN LANGUAGES, by the same 2s.
- 32, 33. ————— FRENCH, ITALIAN, AND ENGLISH LANGUAGES, by the same 2s.
34. GRAMMAR OF THE SPANISH LANGUAGE, by the same 1s.
- 35, 36. DICTIONARY OF THE SPANISH AND ENGLISH LANGUAGES, by the same 2s.
- 37, 38. ————— ENGLISH AND SPANISH LANGUAGES, by the same 2s.
39. GRAMMAR OF THE GERMAN LANGUAGE, by Dr. Strauss 1s.
40. CLASSICAL GERMAN READER, from the best Authors, by the same 1s.
- 41, 42, 43. DICTIONARIES OF THE ENGLISH, GERMAN, AND FRENCH LANGUAGES, by N. E. S. A. HAMILTON, 3 vols. 3s.
- 44, 45. DICTIONARY OF THE HEBREW AND ENGLISH AND ENGLISH AND HEBREW LANGUAGES, containing all the new Biblical and Rabbinical words, 2 vols. (together with the Grammar, which may be had separately for 1s.), by Dr. Bresslau, Hebrew Professor 7s.
46. DICTIONARY OF ENGLISH AND HEBREW LANGUAGES, vol. 3 3s.
47. FRENCH AND ENGLISH PHRASE BOOK 1s.

DOMESTIC MEDICINE; or complete and comprehensive Instructions for Self-aid by simple and efficient Means for the Preservation and Restoration of Health; originally written by M. Raspail, and now fully translated and adapted to the use of the British public. 1s. 6d.

47*. GALVANISM, by Sir William SNOW HARRIS	1s. 6d.
52. RAILWAYS, being vol. ii.	1s.
75*. Supplement to RECENT and FOSSIL SHELLS	1s. 6d.
78*. Rudimentary Treatise on LOCOMOTIVE ENGINES	1s. 6d.
79*. Atlas to the preceding; examples of the several Engines in detail, 4to	4s. 6d.
82***. On WATER WORKS for the Supply of Towns, 3 vols.	3s.
86, 87*. Key to the ELEMENTS OF ALGEBRA	1s. 6d.
101*. On WEIGHTS AND MEASURES OF ALL NATIONS	1s. 6d.
106. SHIP'S ANCHORS, by Geo. COTSELL	1s. 6d.
107. METROPOLITAN BUILDINGS ACT, passed August, 1855, with Notes	2s. 6d.
108. METROPOLITAN LOCAL MANAGEMENT ACT, passed August, 1855, with Notes	1s. 6d.
109. METROPOLITAN BUILDERS' AND CONTRACTORS' PRICE-BOOK, for 1856, with Notes and Engravings on Copper	3s. 6d.
110. LIMITED LIABILITY AND PARTNERSHIP ACT, passed August, 1855, together with the required references to the Acts of Victoria, 7 & 8, and 10 & 11	1s. 0d.
111. FIVE RECENT LEGISLATIVE ENACTMENTS, for Contractors, Merchants, and Tradesmen	1s. 0d.
111* THE NUISANCES REMOVAL ACT, and DISEASES PREVENTION ACT	1s. 0d.

THE WORK ON

BRIDGES OF STONE, IRON, TIMBER, AND WIRE.

In 4 Vols., bound in 3, described in the larger Catalogue of Publications; to which the following is the Supplement, now completed, entitled

SUPPLEMENT TO "THE THEORY, PRACTICE, AND ARCHITECTURE OF BRIDGES OF STONE, IRON, TIMBER, WIRE, AND SUSPENSION,"

In one large Svo. volume, with explanatory Text and 68 Plates, comprising details and measured dimensions.

Bound in half-morocco, uniform with the larger work, price 2*l.* 10*s.*, or in a different pattern at the same price.

LIST OF PLATES.

Cast-iron girder bridge, Ashford, Rye and Hastings Railway.	Mr. Fairbairn's hollow-girder bridge at Blackburn.
Details, ditto.	Waterford and Limerick Railway truss bridge.
Elevation and plan of truss of St. Mary's Viaduct, Cheltenham Railway.	Hollow-girder bridge over the River Medlock.
Iron road bridge over the Railway at Chalk Farm.	Railway bridge over lagunes of Venice.

BRIDGES OF STONE, &C.

- Viaduct at Beangency, Orleans and Tours Railway.
- Oblique cast-iron bridge, on the system of M. Polonceau, over the Canal St. Denis.
- Blackwall Extension Railway, Commercial Road bridge.
- Ditto, enlarged elevation of outside girders, with details.
- Ditto, details.
- Ditto, ditto, and sections.
- Ditto, ditto, ditto.
- Richmond and Windsor main line, bridge over the Thames.
- Ditto, details.
- Ditto, ditto, and sections.
- Orleans and Bordeaux Railway bridge.
- Ditto, sections and details.
- Rouen and Havre Railway timber bridge.
- Ditto, details.
- Ditto, ditto, and sections.
- Viaduct of the Valley of Malanney, near Rouen.
- Hoop-iron suspension bridge over the Seine at Suresne, department de la Seine.
- Hoop-iron suspension foot bridge at Abainville.
- Suspension bridge over the Douro, iron wire suspension cables.
- Ditto, details.
- Glasgow and South-Western Railway bridge over the water of Ayr.
- Ditto, sections and details.
- Plan of the cities of Ofen and Pesth.
- Sections and soundings of the River Danube.
- Longitudinal section of framing.
- No. 1 coffer-dam.
- Transverse framing of coffer-dam.
- Sections of Nos. 2 and 3 of coffer-dam.
- Plan of No. 3 coffer-dam and ice-breakers.
- Plan and elevation of the construction of the scaffolding, and the manner of hoisting the chains.
- Line of soundings,—dam longitudinal sections.
- Dam sections.
- Plan and elevation of the Pesth suspension bridge.
- Elevation of Nos. 2 and 3 coffer-dams.
- End view of ditto.
- Transverse section of No. 2 ditto.
- Transverse section of coffer-dam, plan of the 1st course, and No. 3 pier.
- Vertical section of Nos. 2 and 3 piers, showing vertical bond-stones.
- Vertical cross section of ditto.
- Front elevation of Nos. 2 and 3 piers.
- End elevation of ditto.
- Details of chains.—Ditto.
- Ditto and plan of nut, bolt, and retaining-links.
- Plan and elevation of roller-frames.
- Elevation and section of main blocks for raising the chains.
- Ditto, longitudinal section of fixture pier, showing tunnel for chains.
- Plan and elevation of retaining-plates, showing machine for boring holes for retaining-bars.
- Retaining link and bar.
- Longitudinal plan and elevation of cast-iron beam with truss columns.
- Longitudinal elevation and section of trussing, &c.
- Plan of pier at level of footpath.
- Detail of cantilevers for supporting the balconies round the towers.
- Elevation and section of cantilevers.
- Detail of key-stone & Hungarian arms.
- Front elevation of toll-houses and wing walls.
- Longitudinal elevation of toll-house, fixture pier, wing wall, and pedestal.
- Vertical section of retaining-piers.
- Section at end of fixture pier, showing chain-holes.
- Lamp and pedestal at entrance of bridge.
- Lamp and pedestal at end of wing walls.

Separately sold from the above in a volume, price half-bound in morocco £1. 12s.

An ACCOUNT, with Illustrations, of the SUSPENSION BRIDGE ACROSS the RIVER DANUBE,

BY WILLIAM TIERNEY CLARK, C. E., F. R. S.

With Forty Engravings.

GREAT EXHIBITION BUILDING.

The BUILDING erected in HYDE PARK for the
GREAT EXHIBITION of the WORKS of
INDUSTRY of ALL NATIONS, 1851:

Illustrated by 28 large folding Plates, embracing plans, elevations, sections, and details, laid down to a large scale from the working drawings of the Contractors, Messrs. FOX, HENDERSON, and Co., by CHARLES DOWNES, Architect; with a scientific description by CHARLES COWPER, C.E.

In 4 Parts, royal quarto, now complete, price £1. 10s.,
or in cloth boards, lettered, price £1. 11s. 6d.

. This work has every measured detail so thoroughly made out as to enable the Engineer or Architect to erect a construction of a similar nature, either more or less extensive.

SIR JOHN RENNIE'S WORK

ON THE

**THEORY, FORMATION, AND CONSTRUCTION
OF BRITISH AND FOREIGN HARBOURS.**

Copious explanatory text, illustrated by numerous examples, 2 Vols., very neat
in half-morocco, £18

The history of the most ancient maritime nations affords conclusive evidence of the importance which they attached to the construction of secure and extensive Harbours, as indispensably necessary to the extension of commerce and navigation, and to the successful establishment of colonies in distant parts of the globe.

To this important subject, and more especially with reference to the vast extension of our commerce with foreign nations, the attention of the British Government has of late years been worthily directed; and as this may be reasonably expected to enhance the value of any information which may add to our existing stock of knowledge in a department of Civil Engineering as yet but imperfectly understood, its contribution at the present time may become generally useful to the Engineering Profession.

The Plates are executed by the best mechanical Engravers; the Views finely engraved under the direction of Mr. Pye: all the Engineering Plates have dimensions, with every explanatory detail for professional use.

In octavo, cloth boards, price 9s.

HYDRAULIC FORMULÆ, CO-EFFICIENTS, AND TABLES,

For finding the Discharge of Water from Orifices, Notches, Weirs, Short Tubes, Diaphragms, Mouth-pieces, Pipes, Drains, Streams, and Rivers.

BY JOHN NEVILLE,

ARCHITECT AND C. E., MEMBER ROYAL IRISH ACADEMY, MEMBER INST. C. E. IRELAND, MEMBER GEOLOGICAL SOC. IRELAND, COUNTY SURVEYOR OF LOUTH, AND OF THE COUNTY OF THE TOWN OF DROGHEDA.

This work contains above 150 different hydraulic formulæ (the Continental ones reduced to English measures), and the most extensive and accurate Tables yet published for finding the mean velocity of discharge from triangular, quadrilateral, and circular orifices, pipes, and rivers; with experimental results and coefficients;—effects of friction; of the velocity of approach; and of curves, bends, contractions, and expansions;—the best form of channel;—THE DRAINAGE EFFECTS OF LONG AND SHORT WEIRS, AND WEIR-BASINS;—extent of back-water from weirs; contracted channels;—catchment basins;—hydrostatic and hydraulic pressure;—water-power, &c.

PAPERS AND PRACTICAL ILLUSTRATIONS OF PUBLIC WORKS OF RECENT CONSTRUCTION, BOTH BRITISH AND AMERICAN.

Supplementary to previous Publications.

CONTENTS :

1. Memoir of the Niagara Falls and International Suspension Bridge, by John Roebling, C.E., of U. S. Twenty-two plates.
2. Memoirs of the late Brigadier-General Sir Samuel Bentham, with an Account of his Inventions.
3. The Paddock Viaduct, by John Hawkshaw, F.R.S., C.E. Eight plates.
4. Lockwood Viaduct, by John Hawkshaw, F.R.S., C.E. Four plates.
5. Denby Dale Viaduct, by John Hawkshaw, F.R.S., C.E. Three plates.
6. Tithebarn Street Viaduct, Liverpool, by John Hawkshaw, F.R.S., C.E. Three plates.
7. Newark Dyke Bridge on the Great Northern Railway, by Joseph Cubitt, C.E. Ten plates.
8. Mountain Top Track in the State of Virginia, by Charles Ellet, C.E. of U. S.
9. Preliminaries to Good Building, by Edward Lacy Garbett, Architect.
10. Suggestions for increasing the Circulating Medium in Aid of Commerce and Mechanical Enterprise.

Reviews, Communications, &c., American and Home Correspondence.

*FIFTY ENGRAVINGS, PRICE 25s.

THE
USE OF FIELD ARTILLERY ON SERVICE :

With especial Reference to that of an ARMY-CORPS. For Officers of All Arms
TAUBERT, Captain and Battery Commandant, 8th Regiment Prussian Artillery;
Translated from the German by HENRY HAMILTON MAXWELL,
First Lieutenant Bengal Artillery.

With a vast military force in England and in India, and with all the elements of military greatness, we are undoubtedly deficient in that higher professional knowledge, without which true military vitality cannot effectually be maintained. In order to make this knowledge more accessible to the soldier and to the public at large, this Volume is charged on such terms that even the private, with his limited day's pay, may become a purchaser.

Also it is a faithful and careful translation from the German, by Lieut. Henry Hamilton Maxwell, of the Bengal Artillery, of an important Prussian work on the management and service of artillery, which (although thicker than the ordinary Rudimentary Volumes) the publisher is, through the liberality of Mr. Maxwell, enabled to issue at the price of 1s. 6d.

USEFUL TO EXPERIMENTERS AND LECTURERS:

A SYSTEM OF APPARATUS

FOR THE

USE OF LECTURERS AND EXPERIMENTERS

IN

MECHANICAL PHILOSOPHY.

BY THE REV. ROBERT WILLIS, F.R.S.,

Jacksonian Professor of Natural and Experimental Philosophy in the
University of Cambridge.

. *For Contents of Work see other side.*

WITH THREE PLATES, CONTAINING FIFTY-ONE FIGURES.

CONTENTS

ARTICLE

1. Introductory Remarks.

CHAP. I.—WHEELS AND STUD-SOCKETS.

2. System consists of certain definite parts.
3. Toothed-wheels and other revolving pieces.
4. Key-grooves.
5. Stud-sockets and Collars (figs. 8, 10, 12).
Note.—Double Socket (fig. 9).
6. Stud-sockets of peculiar form (fig. 13).
7. Stud-sockets of peculiar form (fig. 11).

CHAP. II.—FRAME-WORK PIECES.

8. Frame-work.
9. Advantages of Studs.
10. Brackets (figs. 1 to 6).
11. Coach-bolts.
Note.—Clamps (fig. 7).
12. Slit Tables (fig. 16).
13. Sole-blocks (fig. 17).
14. Beds (fig. 20).
15. Rectangles (fig. 19).
16. Examples of Frames. Base-board (fig. 18).
17. Stools (figs. 23 to 26).
18. Posts.
19. Loops (fig. 22).
20. Positions of the Studs and Brackets.
21. Guide-pulleys.
22. Tripod-stretcher.

CHAP. III.—SHAFTS AND TUBE-FITTINGS.

23. Mounting of Shafts.
24. Shafts in carriages (figs. 35, 36, 37).
25. Shafts in Tube-fittings (figs. 29, 39).
26. Shaft-rings.

ARTICLE

27. Shafts between centre-screws.
28. Adapters (fig. 33).
29. Pinned Shaft-rings (fig. 30).
30. Flanch (fig. 32).
31. Lever Arm or Handle (fig. 34).
32. Sets of pieces in definite sizes.
Note on Bolts.
33. Short Shafts in single bearings.
34. Example—Link-work (fig. 40).
35. Other Mountings of short Shafts (fig. 21).
36. Many independent pieces on a common axis.
37. Example—Ferguson's Paradox (fig. 41).
38. Remarks.
39. Recapitulations.
Note on Professor Farish's method.

CHAP. IV.—APPLICATIONS OF THE SYSTEM.

40. System applied to four purposes (as follows):
41. 1st, *Elementary Combinations*.
Example—
42. Roëmer's Wheels (fig. 42).
43. 2nd, *Models of Machines*.
Examples—
44. Repeating Clock (figs. 43, 44).
45. Parallel Motion Curves (fig. 45).
46. Equatorial Clock (figs. 47 to 50).
47. Friction Machine (fig. 46).
48. Models in which the general principles of the system are applicable.
49. Looms.
50. Rope-making Machinery.
51. Organ.
52. 3rd, *Fitting up of Apparatus for Mechanical Philosophy* (figs. 31, 27, 28).
53. Use of Paste-board.
54. Shears (fig. 51).
55. 4th, *Trial of original contrivances*.

In 1 vol. 4to., with 74 plates, extra cloth boards and lettered, price 21s.,

THE CARPENTER'S NEW GUIDE :

OR,

THE BOOK OF LINES FOR CARPENTERS, GEOMETRICALLY EXPLAINED;

COMPRISING ALL THE ELEMENTARY PRINCIPLES ESSENTIAL FOR ACQUIRING A
KNOWLEDGE OF THE THEORY AND PRACTICE OF CARPENTRY.

A NEW EDITION,

FOUNDED ON THAT OF THE LATE PETER NICHOLSON'S STANDARD WORK;

REVISED BY

ARTHUR ASHPITEL, ARCHITECT, F.S.A., F.I.B.A.

TOGETHER WITH

PRACTICAL RULES ON DRAWING,

By GEORGE PYNE, OF OXFORD, ARTIST.

The Work is divided in Three Divisions, with Seventy-four Illustrative Plates, as follows :

- | | |
|---|---|
| <p>Division A.—Practical Geometry, and of Carpentry, explaining the principles in all its parts, by the late Peter Nicholson. (Pages 1 to 80—Plates 1 to 60.)</p> <p>Division B.—Practical Mathematics, Mensuration, &c., by Arthur Ashpitel, Architect. (Pages 1 to 32.)</p> | <p>Division C.—Practical Rules on Drawing, for the Operative Builder and Young Student in Architecture. (Pages 1 to 80—Plates 1 to 14.)</p> |
|---|---|

With 72 Engravings, new, improved, and extended edition, price 2l. 12s. 6d.,
extra large 4to, extra cloth boards and lettered,

THE PRACTICAL RAILWAY ENGINEER :

EXAMPLES OF THE MECHANICAL AND ENGINEERING OPERATIONS AND STRUCTURES
COMBINED IN THE MAKING OF A RAILWAY.

By G. D. DEMPSEY, C.E.

CONTENTS.

- | | |
|---|--|
| <p>Section I.—Curves, gradients, gauge, and slopes.</p> <p>Section II.—Survey and levels for a railway—Parliamentary plan and section—Limits of deviation—Setting out the line—Working plans and sections—Computing quantities—Opening the ground.</p> <p>Section III.—Earthworks, cuttings, embankments, and drains.</p> | <p>Section IV.—Retaining walls, bridges, tunnels, &c.</p> <p>Section V.—Permanent way and construction.</p> <p>Section VI.—Stations, &c.</p> <p>Section VII.—Rolling stock—Carriages, trucks, wheels, and axles—Brakes, and details—Locomotive engines and tenders.</p> <p>Section VIII.—Signals and electric telegraph.</p> |
|---|--|

LIST OF PLATES.

- | | |
|--|--|
| <p>1. Cuttings.</p> <p>2, 3, 4. Earthworks, excavating.</p> <p>5. Ditto, embanking.</p> <p>6. Ditto, waggons.</p> <p>7. Drains under bridges.</p> <p>8. Brick and stone culverts.</p> <p>9. Paved crossings.</p> <p>10. Railway bridges, diagram.</p> <p>11, 12, 13, 14. Bridges, brick and stone.</p> <p>15, 16. Ditto, iron.</p> <p>17, 18, 19, 20, 21. Ditto, timber.</p> <p>22. Centers for bridges.</p> <p>23, 24, 25, 26, 27. "Pont de Montlouis."</p> <p>28. "Pent du Cher."</p> <p>29. Suspension bridge.</p> <p>30. Box-girder bridge.</p> <p>31. Trestle bridge and Chepstow bridge.</p> <p>32. Details of Chepstow bridge.</p> <p>33. Creosoting, screw-piling, &c.</p> <p>34. Permanent way and rails.</p> <p>35. Ditto, chairs.</p> <p>36. Ditto, fish-joints, &c.</p> <p>37. Ditto, fish-joint chairs.</p> <p>38, 39. Ditto, east-iron sleepers, &c.</p> <p>40. Ditto, Stephenson's, Brunel's, Hemans's, Macneill's, and Dockray's.</p> <p>41. Ditto, crossings.</p> | <p>42. Ditto ditto, details.</p> <p>43. Ditto, spring-crossings, &c.</p> <p>44. Ditto, turn-table.</p> <p>45, 46. Terminal station.</p> <p>47, 48, 49. Stations.</p> <p>50. Goods stations.</p> <p>51. Polygonal engine-house.</p> <p>52. Engine-house.</p> <p>53. Watering apparatus.—(A.) Tanks.</p> <p>54. Ditto, (B.) Details of pumps.</p> <p>55. Ditto, (C.) Details of engines.</p> <p>56. Ditto, (D.) Cranes.</p> <p>57. Hoisting machinery.</p> <p>58. Ditto, details.</p> <p>59. Traversing platform.</p> <p>60. Ditto, details.</p> <p>61. Station-roof at King's Cross.</p> <p>62. Ditto, Liverpool.</p> <p>63. Ditto, Birmingham.</p> <p>64, 65. Railway carriages.</p> <p>66. Ditto, details.</p> <p>67, 68. Railway trucks and wheels.</p> <p>69. Iron and covered waggons.</p> <p>70. Details of brakes.</p> <p>71. Wheels and details.</p> <p>72. Portrait.</p> |
|--|--|

In 1 Vol. 4to, extra cloth, boards and lettered, 67 Engravings, 21s.,

DESIGNS AND EXAMPLES OF COTTAGES, VILLAS, AND COUNTRY HOUSES ;

BEING THE STUDIES OF SEVERAL EMINENT ARCHITECTS AND BUILDERS.

CONSISTING OF PLANS, ELEVATIONS, AND PERSPECTIVE VIEWS, WITH
APPROXIMATE ESTIMATES OF THE COST OF EACH.

In imperial 8vo., with 13 large folding Plates, extra cloth boards, price 12s.,

A PRACTICAL AND THEORETICAL ESSAY ON OBLIQUE BRIDGES.

By GEORGE WATSON BUCK, M. Inst. C.E.

TOGETHER WITH A

DESCRIPTION TO DIAGRAMS FOR FACILI- TATING THE CONSTRUCTION OF OBLIQUE BRIDGES.

By W. H. BARLOW, C.E.,

Second Edition, corrected and improved.

In 1 vol. 4to., 50 plates, with dimensions, extra cloth boards, price 21s.,

EXAMPLES FOR BUILDERS, CARPENTERS, AND JOINERS ;

BEING WELL-SELECTED ILLUSTRATIONS OF RECENT MODERN ART AND CONSTRUCTION.

CONTENTS OF PLATES.

- | | |
|---|---|
| 1. Geometrical Staircase. | 26. Elizabethan terminations of a Shop front entablature. |
| 2. " " " | 27. Joinery at Windsor Castle. |
| 3. " " " | 28. " " " |
| 4. " " " | 29. " " " |
| 5. " " " | 30. " " " |
| 6. Construction of the Wooden Columns in King's College. | 31. " " " |
| 7. Details of do. | 32. Gate at the town entrance to the Royal Mews, Windsor. |
| 8. Plan and Elevation of the Athenæum Club House. | 33. Joinery at the Duke of Sutherland's, at Lilleshall. |
| 9. Do. do. Arthur's Club, St. James' Street. | 34. Mullions of Windows, do. |
| 10. Do. do. details. | 35. Plan and Elevation of a Public-house. |
| 11. Do. do. " " | 36. Exeter Hall roof. |
| 12. Design for Verandah. | 37. Country mansion. |
| 13. Details of do. | 38. Italian Designs. |
| 14. Design for Verandah. | 39. " " " |
| 15. Details of do. | 40. " " " |
| 16. Design for Verandah. | 41. Longitudinal Section, do. |
| 17. Details of do. | 42. Windows, Doors, &c. do. |
| 18. Elevation of a Group of New Houses. | 43. Windows, &c. do. |
| 19. Joinery of Doors. | 44. Grand Staircase, do. |
| 20. Base, Surbase, and Dado. | 45. An Elegant Italian façade. |
| 21. Plan and Elevation of Doors. | 46. Penton Meusey Church, Bell Turret. |
| 22. Sections do. do. | 47. Plan and South Elevation of do. |
| 23. Section of the framing or frontispiece of an entablature of a Shop front. | 48. West Elevation of do. |
| 24. Roof at Charter House. | 49. Elevations, with horizontal and vertical sections of the Bell Turret, do. |
| 25. " Clerkenwell Church. | 50. Transverse section of do. |

STAIRCASES AND HAND-RAILS.

Practical Examples and Illustrations of Staircases and Hand-Rails, improved to the present time, with several Elizabethan examples,—geometrical stairs,—plan and section of a geometrical staircase and level landing, with quarter space of windows,—plan and section of a geometrical staircase, with whole space of windows,—cylinders for strings, casings-off, &c. With text and 44 plates, price 18s.

VERANDAHS.

Select Examples and Designs of Modern Verandahs, consisting of elevations, sections, and details, principally selected from the best examples taken from Brighton, 26 plates, cloth boards, price 12s.

In 8vo. size.

FULL-LENGTH

PORTRAIT OF HENRY CAVENDISH, F.R.S.

Only a very few India paper proofs, before the letters of this celebrated Philosopher and Chemist are printed, price 2s. 6d.

Proof in quarto size.

CHARLES MARTEL—BATTLE OF TOURS.

Drawn from Picture painted by STEUBEN, in the Imperial Gallery at Versailles, and engraved by JAMES CARTER. Only a few are printed as proofs, price 1s.

Proofs in quarto size. Drawn from an authentic record, and Engraved by JAMES CARTER.

CROMWELL DICTATING TO MILTON THE DISPATCH IN BEHALF OF THE WALDENSES.

Only a few are printed as proofs, price 1s. 6d.

ITALIAN RURAL ARCHITECTURE.

In one vol. medium 4to., 72 finely executed plates, price in cloth neat, 1l. 16s

THE RURAL AND VILLA ARCHITECTURE OF ITALY,

Portraying the several very interesting examples in that country, with estimates and specifications for the application of the same designs in England; selected from buildings and scenes in the vicinity of Rome and Florence, and arranged for Rural and Domestic Buildings generally.

By CHARLES PARKER, Architect, F.I.B.A., &c.

HINTS TO YOUNG ARCHITECTS:

COMPRISING

ADVICE TO THOSE WHO, WHILE YET AT SCHOOL ARE DESTINED
TO THE PROFESSION;

SUCH AS, HAVING PASSED THEIR PUPILAGE, ARE ABOUT TO TRAVEL
AND TO THOSE WHO, HAVING COMPLETED THEIR EDUCATION,
ARE ABOUT TO PRACTISE:

TOGETHER WITH

A MODEL SPECIFICATION:

INVOLVING A GREAT VARIETY OF INSTRUCTIVE AND SUGGESTIVE MATTER
CALCULATED TO FACILITATE THEIR PRACTICAL OPERATIONS;

AND TO DIRECT THEM IN THEIR CONDUCT, AS THE RESPONSIBLE
AGENTS OF THEIR EMPLOYERS,

AND AS THE RIGHTFUL JUDGES OF A CONTRACTOR'S DUTY.

By GEORGE WIGHTWICK, ARCHITECT.

CONTENTS:—

Preliminary Hints to Young Archi-
tects on the Knowledge of
Drawing.

On Serving his Time.

On Travelling.

His Plate on the Door.

Orders, Plan-drawing.

On his Taste, Study of Interiors.

Interior Arrangements.

Warming and Ventilating.

House Building, Stabling.

Cottages and Villas.

Model Specification:—

General Clauses.

Foundations.

Well.

Artificial Foundations.

Brickwork.

Rubble Masonry with Brick

Mingled.

Model Specification:

Stone-cutting.

—, Grecian or Italian only.

—, Gothic only.

Miscellaneous.

Slating.

Tiling.

Plaster and Cement-work.

Carpenters' Work.

Joiners' Work.

Iron and Metal-work.

Plumbers' Work.

Drainage.

Well-digging.

Artificial Levels, Concrete,

Foundations, Piling and

Planking, Paving, Vaulting,

Bell-hanging, Plumbing, and

Building generally.

Extra cloth boards, price 8s.

THE ENGINEER'S AND CONTRACTOR'S POCKET BOOK,

WITH AN ASTRONOMICAL ALMANACK,

REVISED FOR 1857. In morocco tuck, price 6s.

CONTENTS.

- Air, Air in motion (or wind), and wind-mills.
- Alloys for bronze; Miscellaneous alloys and compositions; Table of alloys; Alloys of copper and zinc, and of copper and tin.
- Almanack for 1855 and 1856.
- American railroads; steam vessels.
- Areas of the segments of a circle.
- Armstrong (R.), his experiment on boilers.
- Astronomical phenomena.
- Ballasting.
- Barlow's (Mr.) experiments.
- Barrel drains and culverts.
- Bell-hanger's prices.
- Blowing a blast engine.
- Boilers and engines, proportions of; Furnaces and chimneys; Marine.
- Bossut's experiments on the discharge of water by horizontal conduit or conducting pipes.
- Brass, weight of a lineal foot of, round and square.
- Breen (Hugh), his almanack.
- Bricks.
- Bridges and viaducts; Bridges of brick and stone; Iron bridges; Timber bridges.
- Burt's (Mr.) agency for the sale of preserved timber.
- Cask and malt gauging.
- Cast-iron binders or joints; Columns, formulæ of; Columns or cylinders, Table of diameter of; Hollow columns, Table of the diameters and thickness of metal of; Girders, prices of; Staunched, Table of, strength of.
- Chairs, tables, weights, &c.
- Chatsburn limestone.
- Chimneys, &c., dimensions of.
- Circumferences, &c. of circles.
- Coal, evaporating power of, and results of coking.
- Columns, cast-iron, weight or pressure of, strength of.
- Comparative values between the present and former measures of capacity.
- Continuous bearing.
- Copper pipes, Table of the weight of, Table of the bore and weight of cocks for.
- Copper, weight of a lineal foot of, round and square.
- Cornish pumping engines.
- Cotton mill; Cotton press.
- Current coin of the principal commercial countries, with their weight and relative value in British money.
- Digging, well-sinking, &c.
- Docks, dry, at Greenock.
- Draining by steam power.
- Dredging machinery.
- DWARF, Table of experiments with H. M. screw steam tender.
- Earthwork and embankments, Tables of contents, &c.
- Experiments on rectangular bars of malleable iron, by Mr. Barlow; on angle and T iron bars.
- Fairbairn (Wm.), on the expansive action of steam, and a new construction of expansion valves for condensing steam engines.
- Feet reduced to links and decimals.
- Fire-proof flooring.
- Flour-mills.
- Fluids in motion.
- Francis (J. B., of Lowell, Massachusetts), his water-wheel.
- French measures.
- Friction.
- Fuel, boilers, furnaces, &c.
- Furnaces and boilers.
- Galvanized tin iron sheets in London or Liverpool, list of gauges and weights of.
- Gas-tubing composition.
- Glynn (Joseph), F. R. S., on turbine water-wheels.
- Hawksby (Mr., of Nottingham), his experiments on pumping water.
- Heat, Tables of the effects of.

THE ENGINEER'S AND CONTRACTOR'S POCKET BOOK.

- Hexagon heads and nuts for bolts, proportional sizes and weights of.
 Hlick's rule for calculating the strength of shafts.
 Hodgkinson's (Eaton) experiments.
 Hungerford Bridge.
 Hydraulics.
 Hydrodynamics.
 Hydrostatic press.
 Hydrostatics.
 Imperial standard measures of Great Britain; Iron.
 Indian Navy, ships of war, and other vessels.
 Institution of Civil Engineers, List of Members of the, corrected to March 15, 1852.
 Iron balls, weight of cast; bars, angle and T , weight of; castings; experiments; hoop, weight of 10 lineal feet; lock gates; roofs; tubes for locomotive and marine boilers; weights of rolled iron.
 Ironmonger's prices.
 Just's analysis of Mr. Dixon Robinson's limestone.
 Latitudes and longitudes of the principal observatories.
 Lead pipes, Table of the weights of.
 Leslie (J.), C.E.
 Lime, mortar, cements, concrete, &c.
 Limestone, analysis of.
 Liquids in motion.
 Locomotive engines; Table showing the speed of an engine.
 Log for a sea-going steamer, form of.
 Machines and tools, prices of.
 Mahogany, experiments made on the strength of Honduras. [wheels.
 Mallet's experiments on overshot
 Marine boilers; engines.
 Masonry and stone-work.
 Massachusetts railroads.
 Mensuration, epitome of.
 Metals, lineal expansion of.
 Morin's (Col.) experiments.
 Motion; motion of water in rivers.
 Nails, weight and length.
 Navies — of the United States; Indian Navy; Oriental and Peninsular Company; British Navy; of Austria; Denmark; Naples; Spain; France; Germanic Confederation; Holland; Portugal; Prussia; Sardinia; Sweden and Norway; Turkey; Russia
 Royal West India Mail Company's fleet.
 New York, State of, railroads.
 Numbers, Table of the fourth and fifth power of.
 Paddle-wheel steamers.
 Pambour (Count de) and Mr. Parkes' experiments on boilers for the production of steam.
 Peacocke's (R. A.) hydraulic experiments.
 Pile-driving.
 Pitch of wheels. Table to find the diameter of a wheel for a given pitch of teeth.
 Plastering.
 Playfair (Dr. Lyon).
 Preserved timber.
 Prices for railways, paid by H. M. Office of Works; smith and founder's work.
 Prony's experiments.
 Proportions of steam engines and boilers.
 Pumping engines; pumping water by steam power.
 Rails, chairs, &c., Table of.
 Railway, American, statistics; railway and building contractor's prices; carriages.
 Rain, Tables of.
 Rammell's (T. W.) plan and estimate for a distributing apparatus by fixed pipes and hydrants.
 Rennie's (Mr. Geo.) experiments; (the late J.) estimate.
 Roads, experiments upon carriages travelling on ordinary roads; influence of the diameter of the wheels; Morin's experiments on the traction of carriages, and the destructive effects which they produce upon roads.
 Robinson (Dixon), his experiments and material.
 Roofs; covering of roofs.
 Ropes, Morin's recent experiments on the stiffness of ropes; tarred ropes; dry white ropes.
 Saw-mill.
 Screw steamers.
 Sewage manures.
 Sewers, castings for their estimates, &c.

THE ENGINEER'S AND CONTRACTOR'S POCKET BOOK.

Signs and abbreviations used in arithmetic and mathematical expressions.

Slating.

Sleepers, quantity in cubic feet, &c.

Smcaton's experiments on wind-mills.

Smith and founder's prices.

Specific gravity, Table of.

Steam dredging; Navigation; Tables of the elastic force; Table of Vessels of war, of America; of England; of India; and of several other maritime nations.

Steel, weight of round steel.

Stone, per lb., stone, qr., cwt., and ton, &c., Table of the price.

Stones.

Strength of columns; Materials of construction.

Sugar-mill.

Suspension aqueduct over the Alleghany River; Bridges over ditto.

Table of experiments with H. M. screw steam tender DWARF; of gradients; iron roofs; latent heats; paddle-wheel steamers of H. M. Service and Post-Office Service; pressure of the wind moving at given velocities; prices of galvanized tinned iron tube; specific heats; the cohesive power of bodies; columns, posts, &c., of timber and iron; the comparative strength, size, weight, and price of iron-wire rope (A. Smith's), hempen rope, and iron chain; corresponding velocities with heads of water as high as 50 ft., in feet and decimals; dimensions of the principal parts of marine engines; effects of heat on different metals; elastic force of steam; expansion and density of water; expansion of solids by increasing the temperature; expansion of water by heat; heights corresponding to different velocities, in French metres; lineal expansion of metals; motion of water, and quantities discharged by pipes of different diameters; power of metals, &c.; pressure, &c., of wind-mill sails; principal dimensions of 28 merchant steamers with screw propellers; of steamers with paddle-wheels; progressive, dilatation of metals by heat, &c.; proportion of real to theoretica

discharge through thin-lipped orifices; quantities of water, in cubic feet, discharged over a weir per minute, hour, &c.; relative weight and strength of ropes and chains; results of experiments on the friction of unctuous surfaces; scantlings of posts of oak; size and weight of iron laths; weight in lbs. required to crush $1\frac{1}{2}$ -inch cubes of stone, and other bodies; weight of a lineal foot of cast-iron pipes, in lbs.; weight of a lineal foot of flat bar iron, in lbs.; weight of a lineal foot of square and round bar iron; weight of a superficial foot of various metals, in lbs.; weight of modules of elasticity of various metals; velocities of paddle-wheels of different diameters, in feet per minute, and British statute miles, per hour; the dimensions, cost, and price per cubic yard, of ten of the principal bridges or viaducts built for railways; the height of the boiling point at different heights;—to find the diameter of a wheel for a given pitch of teeth, &c.

Tables of squares, cubes, square and cube roots.

Teeth of wheels.

Temperature, the relative indications of, by different thermometers.

Thermometers, Table of comparison of different.

Timber for carpentry and joinery purposes; Table of the properties of different kinds of.

Tin plates, Table of the weight of.

Tools and machines, prices of.

Traction, Morin's experiments on.

Tredgold's Rules for Hydraulics, from Eytelwein's Equation.

Turbines, Report on, by Joseph Glynn and others.

Values of different materials.

Water-wheels.

Watson's (H. H.) analysis of limestone from the quarries at Chatburn.

Weight of angle and T iron bars; of woods.

Weights and measures.

West India Royal Mail Company.

Whitelaw's experiments on turbine water-wheels.

THE ENGINEER'S AND CONTRACTOR'S POCKET BOOK.

White's (Mr., of Cowes) experiments on Honduras mahogany.

Wicksteed's (Thos.) experiments on the evaporating power of different kinds of coal.

Wind-mills; of air, air in motion, &c. Woods.

Wrought iron, prices of.

Zinc as a material for use in house-building.

In one Volume 8vo, extra cloth, bound, price 9s.

THE STUDENT'S GUIDE TO THE PRACTICE OF DESIGNING, MEASURING, AND VALUING ARTIFICERS' WORKS;

Containing Directions for taking Dimensions, abstracting the same, and bringing the Quantities into Bill; with Tables of Constants, and copious memoranda for the Valuation of Labour and Materials in the respective trades of Bricklayer and Slater, Carpenter and Joiner, Sawyer, Stonemason, Plasterer, Smith and Ironmonger, Plumber, Painter and Glazier, Paper-hanger. Thirty-eight plates and wood-cuts.

The Measuring, &c., edited by EDWARD DOBSON, Architect and Surveyor. Second Edition, with the additions on Design by E. LACY GARBETT, Architect.

CONTENTS.

PRELIMINARY OBSERVATIONS ON DESIGNING ARTIFICERS' WORKS.

Preliminary Observations on Measurement, Valuation, &c.—On measuring—On rotation therein—On abstracting quantities—On valuation—On the use of constants of labour.

BRICKLAYER AND SLATER.

DESIGN OF BRICKWORK—technical terms, &c.

Foundations—Arches, inverted and erect—Window and other aperture heads—Window jambs—Plates and internal cornices—String-courses—External cornices—Chimney shafts—On general improvement of brick architecture, especially fenestration.

MEASUREMENT.

Of diggers' work—Of brickwork, of facings, &c.

DESIGN OF TILING, and technical terms.

Measurement of Tiling—Example of the mode of keeping the measuring-book for brickwork.

ABSTRACTING Bricklayers' and Tilers' work.

Example of bill of Bricklayers' and Tilers' work.

VALUATION of Bricklayers' work, Earthwork, Concrete, &c.

Table of sizes and weights of various articles—Tables of the numbers of bricks or tiles in various works—Valuation of Diggers' and Bricklayers' labour—Table of Constants for said labour.

EXAMPLES OF VALUING.

1. A yard of concrete.—2. A rod of brickwork.—3. A foot of facing.—4. A yard of paving.—5. A square of tiling.

DESIGN, MEASUREMENT, AND VALUATION OF SLATING.

CARPENTER AND JOINER.

DESIGN OF CARPENTRY—technical terms, &c.

Brestsummers, an abuse: substitutes for them—Joists, trimmers, trimming-joists—Girders, their abuse

DESIGNING, MEASURING, AND VALUING ARTIFICERS' WORKS.

and right use—Substitutes for girders and quarter-partitions—Quarter-partitions—Roof-framing—Great waste in present common modes of roof-framing—To determine the right mode of subdividing the weight, and the right numbers of bearers for leaded roofs—The same for other roofs—Principle of the truss—Considerations that determine its right pitch—Internal filling or *tracery* of trusses—Collar-beam trusses—Connection of the parts of trusses—Variations on the truss; right limits thereto—To avoid fallacious trussing and roof-framing—Delorme's roofing; its economy on circular plans—Useful property of regular polygonal plans—On combinations of roofing, hips, and valleys—On gutters, their use and abuse—Mansarde or curb-roofs.

DESIGN OF JOINERY—technical terms, &c.

Modes of finishing and decorating panel-work—Design of doors.

MEASUREMENT of Carpenters' and Joiners' work—Abbreviations.

Modes of measuring Carpenters' work—Classification of labour when measured with the timber—Classification of labour and nails when measured separately from the timber.

EXAMPLES OF MEASUREMENT, arch centerings.

Bracketing to sham entablatures, gutters, sound-boarding, chimney-grounds, sham plinths, sham pilasters, floor-boarding, mouldings—Doorcases, doors, doorway linings—Dado or surbase, its best construction—Sashes and sash-frames (examples of measurement)—Shutters, boxings, and other window fittings—Staircases and their fittings.

ABSTRACTING Carpenters' and Joiners' work.

Example of Bill of Carpenters' and Joiners' work.

VALUATION of Carpenters' and Joiners' work, Memoranda.

Tables of numbers and weights.

TABLES OF CONSTANTS OF LABOUR.

Roofs, naked floors—Quarter-par-

titions—Labour on fir, per foot cube—Example of the valuation of deals or battens—Constants of labour on deals, per foot superficial.

CONSTANTS OF LABOUR, and of nails, separately.

On battening, weather boarding—Rough boarding, deal floors, batten floors.

LABOUR AND NAILS together.

On grounds, skirtings, gutters, doorway-linings—Doors, framed partitions, mouldings—Window-fittings—Shutters, sashes and frames, staircases—Staircase fittings, wall-strings—Dados, sham columns and pilasters.

VALUATION OF SAWYERS' WORK.

MASON.

DESIGN OF STONEMASONS' WORK.

Dr. Robison on Greek and Gothic Architecture—Great fallacy in the Gothic ornamentation, which led also to the modern 'monkey styles'—'Restoration' and Preservation.

MEASUREMENT of Stonemason's work.

Example of measuring a spandril step, three methods—Allowance for labour not seen in finished stone—Abbreviations—Specimen of the measuring-book—Stairs—Landings—Steps—Coping—String-courses—Plinths, window-sills, curbs—Columns, entablatures, blockings—Cornices, renaissance niches.

ABSTRACTING AND VALUATION.

Table of weight of stone—Table of Constants of Labour—Example of Bill of Masous' work.

PLASTERER.

DESIGN OF PLASTER-WORK in real and mock Architecture.

Ceilings and their uses—Unnecessary disease and death traced to their misconstruction—Sanitary requirements for a right ceiling—Conditions to be observed to render domestic ceilings innocuous—Ditto, for ceilings of public buildings—Barbarous shifts necessitated by wrong ceiling—Technical terms in Plasterers' work.

MEASUREMENT of Plaster-work.

DESIGNING, MEASURING, AND VALUING ARTIFICERS' WORKS.

Abbreviations — Abstracting of Plasterers' work — Example of Bill of Plasterers' work.

VALUATION.

Memoranda of quantities of materials — Constants of Labour.

SMITH AND FOUNDER.**ON THE USE OF METAL-WORK IN ARCHITECTURE.**

Iron not rightly to be used much more now than in the middle ages — Substitutes for the present extravagant use of iron — Fire-proof (and sanitary) ceiling and flooring — Fire-proof roof-framing in brick and iron — Another method, applicable to hipped roofs — A mode of untrussed roof-framing in iron only — A principle for iron trussed roofing on any plan or scale — Another variation thereof — On the decoration of metallic architecture.

MEASUREMENT of Smiths' and Founders' work.

PLUMBER, PAINTER, GLAZIER, &c.

DESIGN, &c. OF LEAD-WORK.

MEASUREMENT OF PAINT-WORK — Abbreviations.

Specimen of the measuring-book — Abstract of Paint-work — Example of Bill of Paint-work.

VALUATION of Paint-work.

Constants of Labour — Measurement and Valuation of GLAZING — Measurement and Valuation of PAPER-HANGING.

APPENDIX ON WARMING.

Modifications of sanitary construction to suit the English open fire — More economic modes of warming in public buildings — Ditto, for private ones — Warming by gas.

In 12mo., price 5s. bound and lettered,

THE OPERATIVE MECHANIC'S WORKSHOP COMPANION, AND THE SCIENTIFIC GENTLEMAN'S PRACTICAL ASSISTANT;

Comprising a great variety of the most useful Rules in Mechanical Science, divested of mathematical complexity; with numerous Tables of Practical Data and Calculated Results, for facilitating Mechanical and Commercial Transactions.

BY W. TEMPLETON,

AUTHOR OF SEVERAL SCIENTIFIC WORKS.

Third edition, with the addition of Mechanical Tables for the use of Operative Smiths, Millwrights, and Engineers; and practical directions for the Smelting of Metallic Ores.

In 8vo., 141 illustrative woodcuts, price 3s., in extra cloth boards, lettered.

THE COMBUSTION OF COAL AND THE PREVENTION OF SMOKE CHEMICALLY AND PRACTICALLY CONSIDERED.

BY C. WYE WILLIAMS, Esq.

ALSO,

Prize Essay on the Prevention of the Smoke Nuisance, imperial 8vo., with fine portrait of the Author; price 2s. 6d.

THE AIDE-MÉMOIRE TO THE MILITARY SCIENCES,

Framed from Contributions of Officers of the different Services, and edited by a Committee of the Corps of Royal Engineers. The work is now completed.

Sold in 3 vols. £4. 10s., extra cloth boards and lettered, or in 6 Parts, as follows:

		£.	s.	d.
Part I.	A. to D., NEW EDITION	0	14	0
II.	D. to F.	0	16	0
III.	F. to M.	0	16	0
IV.	M. to P.	0	14	0
V.	P. to R.	0	16	0
VI.	R. to Z.	1	0	0
		£4 16 0		

In 1 large Volume, with numerous Tables, Engravings, and Cuts,

A TEXT BOOK

For Agents, Estate Agents, Stewards, and Private Gentlemen, generally, in connection with Valuing, Surveying, Building, Letting and Leasing, Setting out, disposing, and particularly describing all kinds of Property, whether it be Land or Personal Property. Useful to

Auctioneers	Assurance Companies	Landed Proprietors
Appraisers	Builders	Stewards
Agriculturists	Civil Engineers	Surveyors
Architects	Estate Agents	Valuers, &c.

In 1 vol. large 8vo, with 13 Plates, price One Guinea, in half-morocco binding,

MATHEMATICS FOR PRACTICAL MEN:

Being a Common-Place Book of PURE AND MIXED MATHEMATICS; together with the Elementary Principles of Engineering; designed chiefly for the use of Civil Engineers, Architects, and Surveyors.

BY OLINTHUS GREGORY, LL.D., F.R.A.S.

Third Edition, revised and enlarged by HENRY LAW, Civil Engineer.

CONTENTS.

PART I.—PURE MATHEMATICS.

CHAPTER I.—ARITHMETIC.

SECT.	SECT.
1. Definitions and notation.	5. Division of whole numbers.— Proof of the first four rules of Arithmetic.
2. Addition of whole numbers.	6. Vulgar fractions.—Reduction of vulgar fractions.—Addition and
3. Subtraction of whole numbers.	
4. Multiplication of whole numbers.	

MATHEMATICS FOR PRACTICAL MEN.

SECT.

subtraction of vulgar fractions.
— Multiplication and division
of vulgar fractions.

7. Decimal fractions.—Reduction of
decimals.—Addition and sub-
traction of decimals.—Multipli-
cation and division of decimals.
8. Complex fractions used in the arts
and commerce.—Reduction.—
Addition.—Subtraction and
multiplication.—Division.—
Duodecimals.
9. Powers and roots.—Evolution.
10. Proportion.—Rule of Three.—De-
termination of ratios.
11. Logarithmic arithmetic.—Use of
the Tables.—Multiplication and
division by logarithms.—Pro-
portion, or the Rule of Three,
by logarithms.—Evolution and
involution by logarithms.
12. Properties of numbers.

CHAPTER II.—ALGEBRA.

1. Definitions and notation.—2. Ad-
dition and subtraction.—3. Mul-
tiplication.—4. Division.—5. In-
volution.—6. Evolution.—7.
Surds.—Reduction.—Addition,
subtraction, and multiplication.
—Division, involution, and evo-
lution.—8. Simple equations.—
Extermination.—Solution of
general problems.—9. Quadratic
equations.—10. Equations in
general.—11. Progression.—
Arithmetical progression.—Geo-
metrical progression.—12. Fra-
ctional and negative exponents.—
13. Logarithms.—14. Computa-
tion of formulæ.

CHAPTER III.—GEOMETRY.

1. Definitions.—2. Of angles, and
right lines, and their rectangles.

PART II.—MIXED MATHEMATICS.

CHAPTER I.—MECHANICS IN GENERAL.

CHAPTER II.—STATICS.

1. Statical equilibrium.
2. Centre of gravity.
3. General application of the princi-
ples of statics to the equilibrium

SECT.

—3. Of triangles.—4. Of qua-
drilaterals and polygons.—5. Of
the circle, and inscribed and cir-
cumscribed figures.—6. Of plans
and solids.—7. Practical geo-
metry.

CHAPTER IV.—MENSURATION.

1. Weights and measures.—1. Mea-
sures of length.—2. Measures
of surface.—3. Measures of so-
lidity and capacity.—4. Mea-
sures of weight.—5. Angular
measure.—6. Measure of time.
—Comparison of English and
French weights and measures.
2. Mensuration of superficies.
3. Mensuration of solids.

CHAPTER V.—TRIGONOMETRY.

1. Definitions and trigonometrical
formulæ.—2. Trigonometrical
Tables.—3. General proposi-
tions.—4. Solution of the cases
of plane triangles.—Right-an-
gled plane triangles.—5. On the
application of trigonometry to
measuring heights and distances.
—Determination of heights and
distances by approximate me-
chanical methods.

CHAPTER VI.—CONIC SECTIONS.

1. Definitions.—2. Properties of the
ellipse.—3. Properties of the hy-
perbola.—4. Properties of the
parabola.

CHAPTER VII.—PROPERTIES OF
CURVES.

1. Definitions.—2. The conchoid.—
3. The cissoid.—4. The cycloid
and epicycloid.—5. The quadra-
tix.—6. The catenary.—Rela-
tions of Catenarian Curves.

of structures.—Equilibrium of
piers or abutments.—Pressure
of earth against walls.—Thick-
ness of walls.—Equilibrium of
polygons.—Stability of arches.
—Equilibrium of suspension
bridges.

MATHEMATICS FOR PRACTICAL MEN.

SECT.

CHAPTER III.—DYNAMICS.

1. General Definitions.
2. On the general laws of uniform and variable motion.—Motion uniformly accelerated.—Motion of bodies under the action of gravity.—Motion over a fixed pulley, and on inclined planes.
3. Motions about a fixed centre, or axis.—Centres of oscillation and percussion.—Simple and compound pendulums.—Centre of gyration, and the principles of rotation.—Central forces.
4. Percussion or collision of bodies in motion.
5. Mechanical powers.—Levers.—Wheel & axle.—Pulley.—Inclined plane.—Wedge and screw.

CHAPTER IV.—HYDROSTATICS.

1. General Definitions.—2. Pressure and equilibrium of Non-elastic Fluids.—3. Floating Bodies.—4. Specific gravities.—5. On capillary attraction.

CHAPTER V.—HYDRODYNAMICS.

1. Motion and effluence of liquids.
2. Motion of water in conduit pipes and open canals, over weirs, &c.—Velocities of rivers.
3. Contrivances to measure the velocity of running waters.

CHAPTER VI.—PNEUMATICS.

1. Weight and equilibrium of air and elastic fluids.
2. Machines for raising water by the pressure of the atmosphere.
3. Force of the wind.

SECT.

CHAPTER VII.—MECHANICAL AGENTS.

1. Water as a mechanical agent.
2. Air as a mechanical agent.—Coulomb's experiments.
3. Mechanical agents depending upon heat. The Steam Engine.—Table of Pressure and Temperature of Steam.—General description of the mode of action of the steam engine.—Theory of the same.—Description of various engines, and formulæ for calculating their power: practical application.
4. Animal strength as a mechanical agent.

CHAPTER VIII.—STRENGTH OF MATERIALS.

1. Results of experiments, and principles upon which they should be practically applied.
2. Strength of materials to resist tensile and crushing strains.—Strength of columns.
3. Elasticity and elongation of bodies subjected to a crushing or tensile strain.
4. On the strength of materials subjected to a transverse strain.—Longitudinal form of beam of uniform strength.—Transverse strength of other materials than cast iron.—The strength of beams according to the manner in which the load is distributed.
5. Elasticity of bodies subjected to a transverse strain.
6. Strength of materials to resist torsion.

APPENDIX.

- I. Table of Logarithmic Differences.
- II. Table of Logarithms of Numbers, from 1 to 100.
- III. Table of Logarithms of Numbers, from 100 to 10,000.
- IV. Table of Logarithmic Sines, Tangents, Secants, &c.
- V. Table of Useful Factors, extending to several places of Decimals.
- VI. Table of various Useful Numbers, with their Logarithms.
- VII. Table of Diameters, Areas, and Circumferences of Circles, &c.
- VIII. Table of Relations of the Arc, Abscissa, Ordinate and Subnormal, in the Category.
- IX. Tables of the Lengths and Vibrations of Pendulums.
- X. Table of Specific Gravities.
- XI. Table of Weight of Materials frequently employed in Construction.
- XII. Principles of Chronometers.
- XIII. Select Mechanical Expedients.
- XIV. Observations on the Effect of Old London Bridge on the Tides, &c.
- XV. Professor Farish on Isometrical Perspective.



UNIVERSITY OF CALIFORNIA LIBRARY
BERKELEY

Return to desk from which borrowed.

This book is DUE on the last date stamped below.

<p>22AP'55 I W</p> <p>2104 STPT</p> <p>REC'D LD</p>	<p>8 00.33 -K</p> <p>26 Jan '65 I W</p> <p>REC. CIR.</p> <p>JAN 25 1965 - 1 M</p> <p>OCT 20 1970 3</p> <p>NOV 21 70 -9AM 00</p>	<p>FEB 26 1976 0.11</p> <p>REC. C.</p> <p>FEB 7 1980</p> <p>FEB 4 1980</p>
---	---	--

U C. BERKELEY LIBRARIES



C054732102

M520000

1980

4
1
1

